

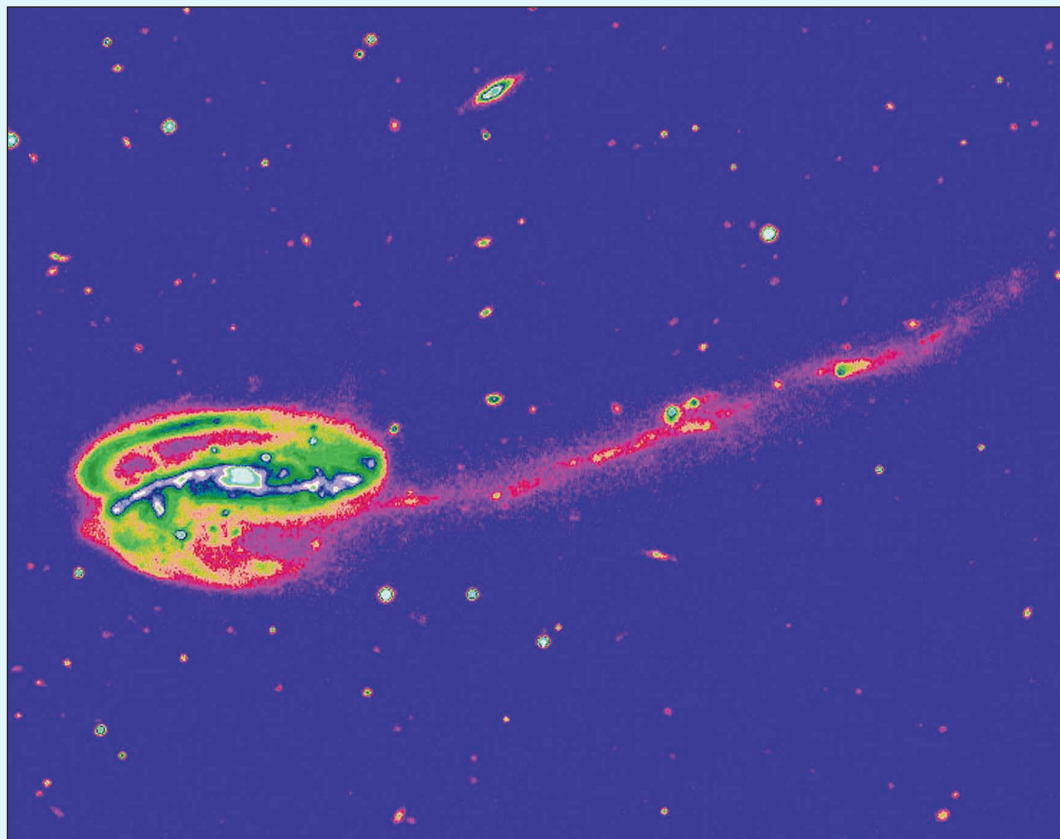

THE ISAAC NEWTON GROUP OF TELESCOPES

NEWSLETTER



From observations carried out as part of the ING Wide-Field Survey astronomers have been able to identify one place where a dark galaxy may exist. They noticed that a galaxy called UGC 10214, shown above, has a stream of material flowing out of it, as if it is interacting with another galaxy. In this case, the stream of material is apparently flowing towards nothing. Picture credit: Neil Trentham and Simon Hodgkin (IoA). Colour composition by Nik Szymanek.

Message from the Director

Dear Reader,

With this fourth issue of the ING Newsletter we kick off this —still junior— communication channel for the observatory into the new Millennium.

Since the previous issue, NAOMI has seen its first part of the technical commissioning programme and passed most tests very well. Although there remains much work to fully test and characterise this complex system, NAOMI was shown to be capable of delivering diffraction limited images. Unfortunately poor weather hampered the first science observations that were scheduled in December and January. This in spite of the current La Palma winter being one of the best for astronomy in recorded history of the observatory! However, there will be opportunities for service observations later this semester, when the weather is less likely to play its tricks. If you're interested in using NAOMI for your science programme: watch the schedule on our web pages!

The commissioning of NAOMI is the first important step in ING's adaptive optics programme. The

following phases are now well under way with the development of a coronagraph (called OSCA) at UCL, and the kick-off of the project in collaboration with the Observatoire de Lyon to convert the OASIS integral field spectrograph to work with NAOMI.

Also on the second main development strand for the WHT, that of wide field spectroscopy, very good progress has been made. The construction of the new fibre unit that will feed the WYFFOS spectrograph from the prime focus is well advanced and on track for commissioning this summer. The new unit will improve throughput of the fibres and enhance S/N as the smaller diameter fibres will receive much less sky contamination.

Data rates from telescopes are generally on the rise. This is certainly also the case for the ING telescopes. Large volumes of data require new techniques to extract the scientifically relevant information in the most effective way. In this respect the ING Wide Field Survey that has been running on the INT for

THE ISAAC NEWTON GROUP OF TELESCOPES

The Isaac Newton Group of Telescopes (ING) consists of the 4.2m William Herschel Telescope (WHT), the 2.5m Isaac Newton Telescope (INT) and the 1.0m Jacobus Kapteyn Telescope (JKT), and is located 2,350m above sea level at the Roque de Los Muchachos Observatory (ORM) on the island of La Palma, Canary Islands, Spain. The WHT is the largest telescope of its kind in Western Europe.

The construction, operation, and development of the ING Telescopes is the result of a collaboration between the United Kingdom and the Netherlands. The site is provided by Spain, and in return Spanish astronomers receive 20 per cent of the observing time on the telescopes. The operation of the site is overseen by an International Scientific Committee, or Comité Científico Internacional (CCI).

A further 75 per cent of the observing time is shared by the United Kingdom and the Netherlands. On the JKT the international collaboration embraces astronomers from Ireland. The remaining 5 per cent is reserved for large scientific projects to promote international collaboration between institutions of the CCI member countries.

The ING operates the telescopes on behalf of the Particle Physics and Astronomy Research Council (PPARC) of the United Kingdom and the Nederlandse Organisatie voor Wetenschappelijk Onderzoek (NWO) of the Netherlands. The Roque de Los Muchachos Observatory, which is the principal European northern hemisphere observatory, is operated by the Instituto de Astrofísica de Canarias (IAC).



(Continued from front cover)

some time now has been leading the way. Survey activities will become increasingly important. With the advent of large scale surveys the problems of data archiving and processing become very significant. Clearly the old-fashioned archive consisting of a collection of tapes in a cupboard is something of the past. At the ING, in close collaboration with the Cambridge Astronomy Survey Unit (CASU), an impressive data pipeline has been developed. Key elements of this at the observatory are the DVD and CD towers for on-line data storage, and the Beowulf data reduction PC cluster with automatic pipeline data reduction software. Ultimately the data are archived in Cambridge as part of the existing and well developed ING archive, which is accessible over the web. With these developments the ING telescopes fit well into the exciting future of e-science and 'grid' developments.

Last year a study was published on the contribution of astronomical facilities on high-impact science. In this study the WHT featured in a very positive way. The highlights of this study are presented in an article in this Newsletter. Given the proven success of the WHT, it is a shame to see that there remains very significant uncertainty over the future of the observatory. Clearly a world class telescope like the WHT with its year-after-year high scientific output will be able to supply the astronomical community with top-quality astronomical data for many more years. I would like to invite astronomers who share this opinion to convey their views to the appropriate committees.

Dr. René Rutten

The ING Board

The ING Board oversees the operation, maintenance and development of the Isaac Newton Group of Telescopes, and fosters collaboration between the international partners. It approves annual budgets and determines the arrangements for the allocation of observing time on the telescopes. ING Board members are:

Prof. T. de Zeeuw, *Chairman* – Leiden
 Dr. W. Boland – NWO
 Dr. A. Collier-Cameron – St Andrews
 Dr. A. Mampaso – IAC, Tenerife
 Prof. M. Merrifield – Nottingham
 Dr. P. Murdin – PPARC
 Prof. J. Drew – London
 Dr. C. Vincent, *Secretary* – PPARC

The Instrumentation Working Group

The Instrumentation Working Group for ING was recently re-constituted primarily to provide scientifically informed advice on the instrumentation programme for the ING telescopes. The IWG fulfils an important function as intermediate between ING and the user community. IWG members are:

Dr. R. G. McMahon, *Chairman* – Cambridge
 Dr. R. García – IAC, Tenerife
 Dr. G. B. Dalton – Oxford
 Dr. V. S. Dhillon – Sheffield
 Dr. S. F. Green – Kent
 Dr. K. Kuijken – Groningen
 Dr. N. A. Walton, *Secretary* – ING

The ING Newsletter

ISSN 1575–8958 (printed version)
 ISSN 1575–9849 (electronic version)
 Legal license: TF–1959/99

Published in Spain by THE ISAAC
 NEWTON GROUP OF TELESCOPES (ING).

Apartado 321; 38700 Santa Cruz de La Palma; Canary Islands; Spain.

Telephone: +34 922 425400

Fax: +34 922 425401

URL: <http://www.ing.iac.es/>

Editorial team: J. Méndez, R. Rutten and D. Lennon.

Designer: J. Méndez.

Preprinting: Gráficas El Time.

Tel.: +34 922 416651

Printing: Gráficas Sabater.

Tel.: +34 922 623555

The ING Newsletter is primarily published on-line at <http://www.ing.iac.es/PR/newsletter/> in html, pdf and postscript format. Notification of every new issue is given by e-mail using the [INGNEWS] mailing list. More information on [INGNEWS] can be found on page 32. Requests for one-off printed copies can be emailed to Javier Méndez (jma@ing.iac.es).

The ING Newsletter is published twice a year in March and September. If you wish to submit a contribution, please contact Javier Méndez (jma@ing.iac.es). Submission deadlines are 15 July and 15 January.

The ING Wide Field Imaging Survey

This is a special report on the first three years of the ING Wide Field Imaging Survey and the coming projects. Below we present four articles covering different aspects of the survey.



Science Highlights from the ING Wide Field Survey

Nicholas A. Walton, Daniel J. Lennon (ING) and Mike J. Irwin, Richard G. McMahon (IoA)

The Isaac Newton Group's public access Wide Field Survey (WFS) makes use of the Wide Field Camera on the Isaac Newton Telescope to carry out a range of competitively judged survey programmes. Multicolour data, immediately accessible to the UK and NL communities, over 200+ square degrees to a typical depth of 24 mag (from Sloan-Gunn u' through z' filters) is being obtained.

The WFS archive now contains some 0.7 TB of reduced and calibrated image data on-line. This equates to some 2000 square degrees of sky coverage and currently represents the world's largest reduced CCD sky survey available on-line.

This article gives a brief overview of the WFS's first five semesters of operation, describing some science highlights. This issue of the *ING Newsletter* also contains associated articles describing the second round of programmes of the WFS (René Rutten, this issue) and a more detailed look at the data reduction pipeline employed to handle WFS data (Robert Greimel et al., this issue). Attention is also paid to the development of the Wide

Field Camera and its associated data acquisition system in the article by Walton et al. (this issue).

Full details and access to the survey are available at the ING WFS portal at:

<http://www.ing.iac.es/WFS>

or the CASU page at:

<http://www.ast.cam.ac.uk/~wfcSUR>.

programmes encompassed a wide range of topics: from growth of structure and clusters of galaxies to stellar populations to outer solar system studies. The data is immediately publicly accessible to the UK and NL communities and after a year to the rest of the world. The location of the fields surveyed (till November 2000) are shown graphically in Figure 1.

1 The First Wide Field Survey Programmes

The competitively judged 1st period (Aug 1999 – Jan 2001) WFS science

2 The Wide Field Survey Science

In the following, some preliminary science results resulting from WFS

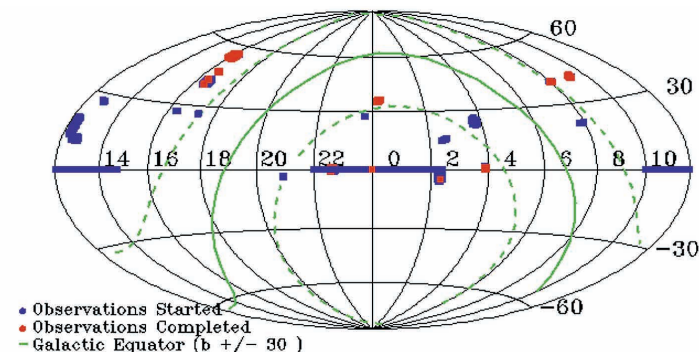

Figure 1. Location of WFS fields as observed to November 2000.

programmes are outlined. In addition, Sharp et al. (2001, this issue) discuss the discovery of High-Redshift Quasars with WFS data.

2.1 Wide Angle Survey (WAS) Highlights

This main WFS programme (PI: Richard McMahon) brought together a diverse range of scientific topics, merging the observational programme to increase scientific effectiveness. A representative selection of core programmes is highlighted. An overview of the main programmes being addressed in the WAS can be found in Walton et al. (1999), McMahon et al. (2001) and at http://www.ast.cam.ac.uk/~rgm/int_sur/

2.1.1 Brown Dwarfs in The Pleiades

WFS survey data for $\sim 2.7 \text{ deg}^2$ has been obtained in the Pleiades. Ninety brown dwarf candidates were identified from the $i', i' - Z$ diagram. IR photometry of this sample confirmed twenty five as brown dwarfs. The faintest, at $I=22.5$ and with a colour of $I-K=5.6$, possibly makes this the lowest mass brown dwarf yet found in the Pleiades. In order to understand the low-mass end of the cluster mass function, masses below $35 M_{\text{Jup}}$ must be probed. Further observations are extending the 'Pleiades survey' out to the semi-tidal radius to determine the spatial distribution of brown dwarfs in the cluster and to assess the form of the mass function.

2.1.2 Intermediate Type Ia Supernovae

Major progress in the determination of the fundamental cosmological parameters (Ω, Λ) has been made using Type Ia supernovae (SN) at $0.4 < z < 1$ (see e.g. Perlmutter et al., 1999, Riess et al., 1998). However, these results are limited by systematic errors in the properties of low redshift SN. The WAS

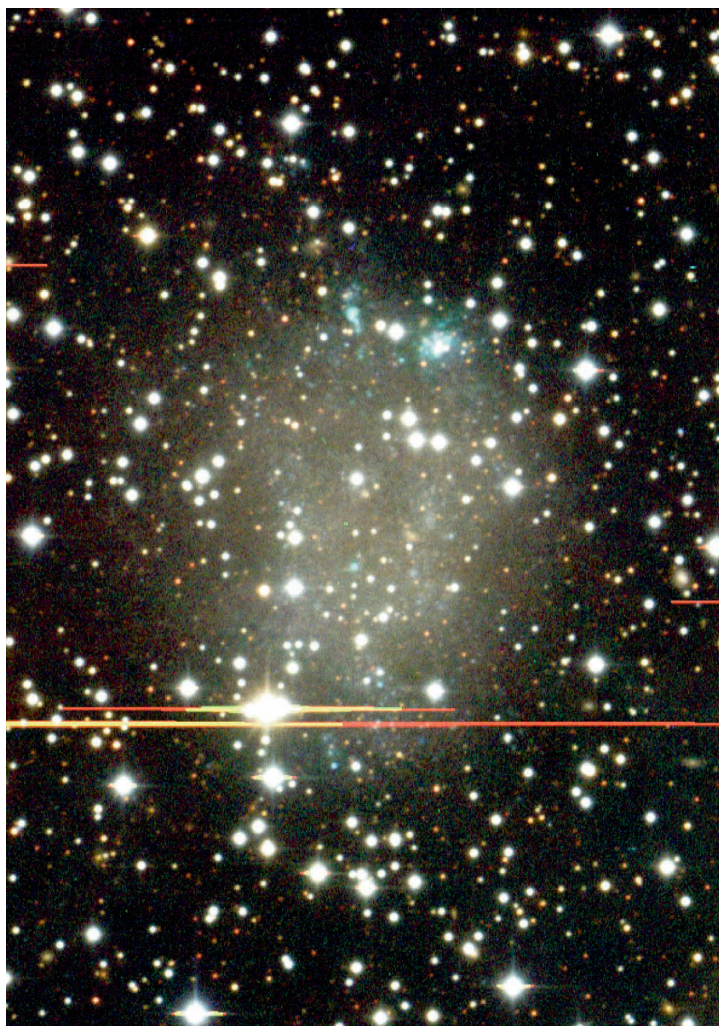

Figure 2. An example of a low surface brightness dwarf galaxy, this one in Cepheus, recently discovered by Whiting, Hau and Irwin. The image is a colour composite picture created from 1200 second exposures in g', r' and i' -band images taken in sub-arcsec conditions.

survey identified ~ 20 new Type Ia SN in the critical range $0.1 < z < 0.4$, analysis of which is allowing a detailed treatment of these systematic errors.

2.1.3 New Low Surface Brightness (LSB) Galaxies in Virgo

As part of the Virgo survey component, led by Jon Davies (Cardiff), some 25 square degrees of Virgo were obtained in the B photometric band, and the pipeline processed object catalogues were analysed. More than 500 LSB galaxies with $B_{\text{tot}} < 21$ were discovered by comparing the light profiles of the millions of objects in the data frames with those of previously known template LSB galaxies. Figure 2 shows

an example LSB dwarf galaxy. The luminosity function in Virgo, when combined with the much flatter function found in the field, will enable the efficiency of low mass galaxy formation in differing environments to be investigated. First results are indicating a strong environmental dependence, which would need to be taken into consideration by Cold Dark Matter theories.

2.1.4 The Millennium Galaxy Catalogue (MGC)

The MGC, being completed by Simon Driver (St. Andrews), aims to define a complete galaxy catalogue of the local environment covering a homogeneous volume ($V \sim 100 h^{-3} \text{ Mpc}^3$) for all galaxy types independent of

surface brightness selection. The MGC survey strip encompasses 2dF galaxy red-shift survey fields, thus some ~4000 spectroscopic red-shifts exist for galaxies in this region (Cross et al., 2001). Data for the strip of 0.5 degrees by 70 degrees has now been obtained. Further details can be found at the MGC home page

(<http://star-www.st-and.ac.uk/~spd3/mgc/mgc.html>)

2.2 The Oxford Deep WFC Survey

This represents the 'deep' component of the WFS (PI: Gavin Dalton). Its primary goal is to investigate the angular clustering properties of galaxies as a function of colour to a red-shift of $z \sim 1$. Current analysis has allowed a measure of angular clustering to ~ 0.2 degree scales for $25 < R < 25.5$.

Extremely Red Objects ($R-K > 6$) are being found by comparing the WFS data with K band data from the MDM 1.3-m telescope. Preliminary analysis indicates that there are distinct ERO populations representing post-starburst galaxies and old cluster ellipticals at $z > 1$.

The Oxford data are also being used to search for Lyman break galaxies at $z=3$ and $z=4$. In particular, the correlation length of these galaxies is being found as the Oxford data set covers larger areas to similar depths to that used in previous Lyman break galaxy search campaigns (e.g. Steidel et al., 1996). Further details of the Oxford Deep Survey can be found at <http://www-astro.physics.ox.ac.uk/~gbd/WFC/>.

2.3 Faint Sky Variability Survey (FSVS)

This survey (PI: Ed van den Heuvel) forms the 'variability' component of the WFS, obtaining deep wide field BVI photometric data towards high and moderate galactic magnitudes (Groot et al., 2001). Photometric

accuracies of up to 3 millimag (for $V=17$ mag objects) have been obtained. Over 100,000 point sources have had light curves constructed. The main scientific targets include CVs, RR Lyrae stars, optical transients of GRB's, Kuiper Belt objects and so forth. Variability and colour selected samples are being spectroscopically followed up with 4-m and 10-m class telescopes. Full details and access to the processed data sets for this project can be found at

<http://zon.wins.uva.nl/~fsvs/>.

2.4 Dark Galaxies

Trentham and co-workers (2001) have suggested that galaxies with significant mass could exist with no stars, made up entirely of dark matter. This theory extrapolates from the currently well known observation that bright galaxies contain significant amounts of dark matter, with mass to light ratios of 10 to 1 not being uncommon. One example of such a dark galaxy has

been identified from WFS images — the galaxy UGC 10214 (see Figure 3) has a stream of material flowing out of it, typical of those seen in interacting galaxy pairs (see Figure 4). However, there is no other galaxy or source of visible light present, the companion interacting object is therefore dark.

3 The Next Years: New Programmes

The strength of the WFS concept was confirmed with support for the continuation of the programme for a further three year period. The programmes supported, a blend of continuing 1st round programmes supplemented with new programmes, are discussed elsewhere (René Rutten, this issue).

The WFS optical data will be supplemented from Spring 2001 with

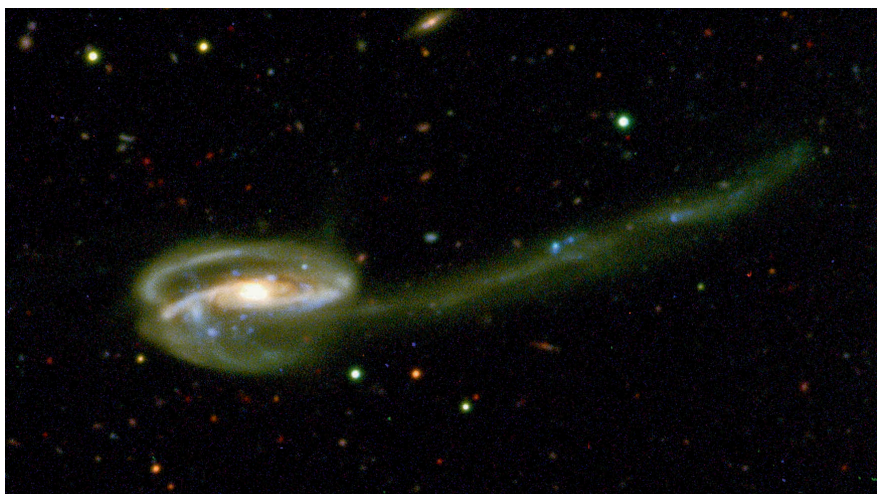

Figure 3. The false colour image (u' , g' , i' filters) of galaxy UGC 10214, thanks to Simon Hodgkin at Cambridge Astronomical Survey Unit (CASU).

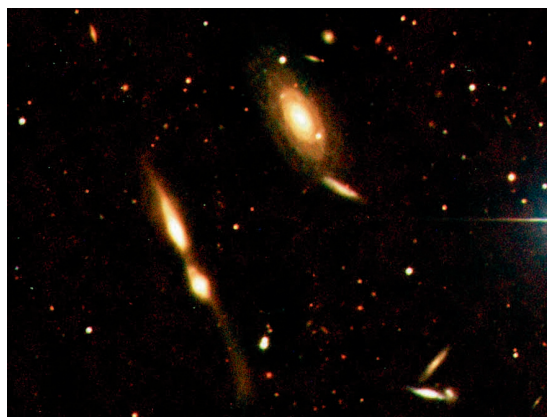

Figure 4. A pair of interacting galaxies —taken from the FSVS— see

<http://zon.wins.uva.nl/~fsvs/html/images.html>.

near-IR J and H band data. This will be obtained with the IoA's CIRSI IR camera (see <http://www.ast.cam.ac.uk/~optics/cirsi/>) operating on the INT.

4 Data Products and Usage

Some 35000 4×2k science frames had been accumulated through the WFS in the period August 1998 till November 2000. This equates to some 0.7 TB of processed science data with derived catalogues amounting to an additional of 20 GB. The science data volume corresponds to some 2000 square degrees of sky.

The WWW pages to the WFS at both CASU and the ING are being or have been redesigned to improve the interface to the WFS data products. The calibration and characterisation data is of use in the reduction of all WFC data.

Improvements have been made to the astrometric solutions, these now being better than 100mas (internal) across the CCDs. The photometric calibration of the survey is progressing with the development of automatic extraction of standard Landolt calibration field

observations, and the subsequent photometric solutions being applied to the object catalogue data.

5 Closing Remarks

The WFS is now running routinely. Significant data sets now exist and are available to the community. A wide range of scientific analyses is currently underway, with many exciting new results on the horizon. The WFS data, in conjunction with possible complementary near-IR data from the UKIRT WFCAM, will provide an important resource to the UK/NL communities.

The operation of the survey, and implementation of the supporting infrastructure (observing systems, processing systems, data dissemination) is providing vital experience to the UK in advance of more major survey activities planned with the next generation survey facilities such as the VISTA telescope.

References:

Cross, N., Driver, S., Lemon, D., 2001, in Proc 'New Era of Wide-Field Astronomy', eds R. G. Clowes, A. J. Adamson, G. E.

Brommage, *ASP Conference Series* (in press) (astro-ph/0010418).

Everett, M. E., et al., 2001, *MNRAS* (submitted) (astro-ph/0009479).

Greimel, R., Lewis, J. R., Walton, N. A., 2001, *ING Newsl*, 4 (this issue).

Groot, P. J., et al., 2001, *MNRAS* (submitted) (astro-ph/0009478).

McMahon, R. G., Walton, N. A., Irwin, M. J., Lewis, J. R., Bunclark, P. S., Jones, D. H., 2001, *NewAR*, **45**, 97.

Perlmutter, S., et al., 1999, *ApJ*, **517**, 565.

Riess A. G., et al., 1998, *AJ*, **116**, 1009.

Rutten, R. G. M., 2001, *ING Newsl*, 4 (this issue).

Sharp, R. S., Hodgkin, S. T., McMahon, R. G., Irwin, M. J., 2001, *ING Newsl*, 4 (this issue).

Steidel, C. C., Giavalisco, M., Dickinson, M., Adelberger, K. L., 1996, *ApJ*, **462**, L17.

Trentham, N., Moeller, O., Ramirez-Ruiz, E., 2001, *MNRAS* (submitted) (astro-ph/0010545).

Walton, N. A., Irwin, M. J., McMahon, R. G., Lewis, J. R., 1999, *ING Newsl*, **1**, 3.

Walton, N. A., Lennon, D. J., Greimel, R., Irwin, M. J., Lewis, J. R., Rixon, G. T., 2001, *ING Newsl*, 4 (this issue). □

Nic Walton (naw@ing.iac.es)

The Wide Field Camera and Infrastructure

Nicholas A. Walton, Daniel J. Lennon, Robert Greimel (ING) and Mike J. Irwin, James R. Lewis, Guy T. Rixon (IoA)

This paper gives a brief overview of the development of the Wide Field Camera and its associated data acquisition system.

1 The Wide Field Survey Infrastructure

1.1 The Wide Field Camera

The Wide Field Camera (WFC) was originally envisaged as a system containing four $2k \times 2k$ Loral devices (Ives et al., 1996) and was commissioned in this format during May 1997. Unfortunately the Loral devices never functioned to specification, thus in 1997, it was decided to retrofit the camera with $4k \times 2k$ EEV42 devices. The large format of these involved a redesign of the mounting system within the WFC, and enabled effectively the entire field of view provided at the prime focus of the INT to be imaged. The 'new' WFC was commissioned at the INT in April 1998. Figure 1 shows the WFC.

1.2 The WFC Auto-guider

The WFC's auto-guider system, employing a Loral $2k \times 2k$ CCD operating in frame transfer mode, is mounted on the same baseplate as the science CCDs. It views the edge of the WFC field through the same filter as being employed for the observations. This has the disadvantage that guide stars may sometimes not be available in the U band. However, it does mean that the geometry of the guider with respect to the science CCDs is extremely stable, thus aiding (re) acquisition and guiding.

2 The UltraDAS

The advent of large detector arrays was a main driver towards the

implementation of a more sophisticated data acquisition system (UltraDAS) to replace the legacy DAS system. This included the introduction of an interim data acquisition system that was a pre-cursor to UltraDAS (Walton et al., 1998). The UltraDAS was designed with the intention to support all ING optical and infra-red detectors, and to enable specialist modes such as high-speed photometry (Rixon et al., 2000) and was implemented at the WFC in September 1999. The UltraDAS produces FITS format files using the Multi-Extension FITS (MEF) format. This is further discussed by Walton and Rixon (2000).

2.1 UltraDAS Design

The primary concern with UltraDAS was that it enables silicon limited readout speeds. The $4 \times 2k$ detectors in use at the ING are designed with maximum readout speeds of a few microseconds/pix, implying a readout time of some 30sec for the full CCD. The HgCdTe array employed in INGRID can have frame rates of a Hz. UltraDAS delivers these readout speeds.

The UltraDAS client-server architecture (see Figure 2) was designed such as to be common for all ING detectors. However, the system is structured so as to be adaptable to meet current and possible future detector requirements. The UltraDAS commands can be called from shell scripts, as can the telescope, auto-guider and instrument commands. This facilitates semi-automated observing.

2.2 The SDSU Controllers

The detector control electronics forms the heart of the DAS. UltraDAS employs the Generation-2 detector controller from the CCD laboratory at San Diego State University (SDSU-2

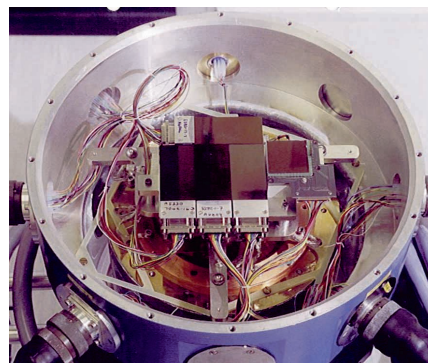

Figure 1. This image shows the four EEV science CCDs in the open dewar. The square CCD to the right is the Loral CCD used for auto-guiding. Each EEV is approximately $28mm \times 56mm$ in size.

controllers) (Leach et al., 1998). The SDSU-2 controller is a highly-programmable device enabling the hardware to be standard and interchangeable. A few boards in the SDSU-2 controllers are different for IR and optical applications. All the specialisation and tuning for a particular detector is in code that is held on the unix computer-network and downloaded at each reset of the controller.

The SDSU-2 controllers communicate over fibre-optic pairs to a PCI based interface board in a SUN SPARCstation™. The board provides a > 16 Mpixel buffer and this reduces the real-time IO requirements when processing the data flow. As of February 2001, the PCI interface drivers have not been brought into operation, thus the system currently runs via a SBUS interface card with somewhat increased readout processing overheads resulting.

The SDSU-2 controllers coupled with UltraDAS ensure that the ING detectors are silicon limited on readout, with no extra overheads being added due to the processing data acquisition software.

3 The Observing Control System

To support the implementation of the new UltraDAS and the WFC, the observing control system was updated (Walton et al., 1998). This involved modernisation of the Telescope Control System (TCS). The Instrument Control System (ICS) for the WFC includes integrated ICS and DAS functionality. All control sub-systems (e.g. the DAS, TCS, ICS for the WFC, auto-guider control, etc.) have been integrated into a unified system. The implementation allows for automated control of the WFC with the INT.

The WFC was the first instrument at the ING where the servers controlling the telescope, auto-guider, instrument and detectors all have common interfaces and can be controlled in parallel from one client-programme. This has enabled a number of observing tools to be implemented. The SMARTFLAT utility uses the INT's prime-focus auto-guider as an exposure meter for taking flat-field observations in twilight, whilst the FOCUSRUN utility is employed to determine the best telescope-focus.

4 Integration with the ING Data Management System

A key design consideration in the design of the UltraDAS was that it should be compatible with the ING's Data Management System (DMS) (Lewis & Walton, 1998). The UltraDAS is thus architecturally integrated with the DMS, ensuring that the WFC data generated is available to be pipeline processed and archived in both the ING's science (<http://archive.ast.cam.ac.uk/ingarch>) and engineering archive systems (http://orion.roque.ing.iac.es/ing_eng).

The processing flow of WFC data is described more fully by Greimel et al. (this issue). Their article covers the pipeline processing system

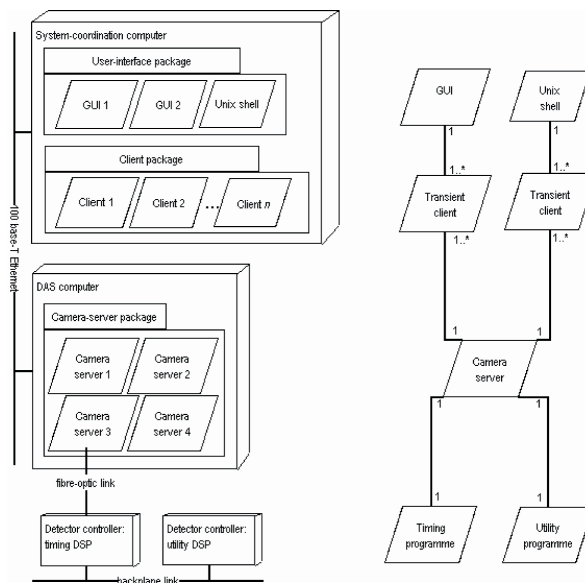

Figure 2. The left hand chart shows the WFC hardware network, whilst the right hand chart represents the UltraDAS client layering.

developed for WFC imaging data, the 'Gigawulf' processing unit implemented to power the pipeline and the data's integration into the archiving system.

4.1 Quality Control

The reduced data products from the WFC have an operational benefit in addition to their scientific worth. A number of key quality control performance measures are extracted on a nightly basis from the generated object catalogues. These indicators include instrumental information such as sky brightness levels, image quality (ellipticity, FWHM of images), and throughputs from extraction of standard star fluxes and comparisons with known zero point data. An example of can be seen Wide Field Survey Release 0.1 at http://www.ast.cam.ac.uk/~wfc_sur/release.summary. The quality indicators enable early feedback as the functional performance of the WFC.

5 Closing Remarks

The WFC is now fully operational in a stable state at the INT. Later in 2001 UltraDAS will be upgraded to run with the PCI interface cards (as opposed to the SBUS cards currently used), resulting in somewhat reduced readout overheads (the readout time will remain as now, but associated

readout processing overheads will fall dramatically).

For the future, the observing scripts will be standardised, with calibration scripts, for example, offered to observers. With the move to more survey style observing, it is envisaged that routine calibration sequences will be carried out via these scripts.

Acknowledgements

The authors would like to thank the many people who have worked to make the Wide Field Camera and the associated control data systems the success that they have proven to be.

References:

- Greimel, R., Lewis, J. R., Walton, N. A., 2001, *ING Newsl*, 4 (this issue)
- Ives, D. J., Tulloch, S. M., Churchill, J., 1996, *Proc SPIE*, 2654, 266.
- Leach, R. W., Beale, F. L., Eriksen, J. E., 1998, *Proc SPIE*, 3355, 512.
- Lewis, J. R., Walton, N. A., 1998, *Proc SPIE*, 3349, 263.
- Rixon, G. T., Walton, N. A., Armstrong, D. B., Woodhouse, G., Tulloch, S. M., 2000, *Proc SPIE*, 4009, 132.
- Walton, N. A., Bunclark, P. S., Fisher, M. P., Gribbin, F. J., Jones, E. L., Rees, P. C. T., Rixon, G. T., 1998, *Proc SPIE*, 3351, 197.
- Walton, N. A., Rixon, G. T., 2000, *ING Newsl*, 3, 31. ☐

Nic Walton (naw@ing.iac.es)

Pipeline Data Processing

Robert Greimel (ING), Jim R. Lewis (IoA) and Nicholas A. Walton (ING)

In the era of 8-m telescopes, there is increasing pressure to operate 4-m class telescopes in the most economic, efficient and effective manner possible. The ING is addressing these three 'E's, in part with its implementation of an improved streamlined data flow system encompassing data acquisition, pipeline processing and subsequent archiving and distribution of raw and processed data products.

The advent of large format CCD arrays and large infra-red detectors has led to an explosion in data volumes. For example, the current data rates at the ING are determined by the Wide Field Camera (WFC) (see e.g. Walton et al., this issue) on the INT which typically generates ~8 GB/night and the IR camera INGRID on the WHT generating some ~4 GB/night. In total, data flows can amount to 15–20 GB/night from all telescopes.

The current day availability of affordable processing power and storage capability has opened the possibility to provide (semi)-processed data products at the point of data origin to the visiting astronomer. These reduced data products will form the core data resource of new 'Virtual Observatories' (see e.g. <http://www.astro.caltech.edu/nvoconf/>).

1 Data Processing Pipeline

Details of the ING's data processing pipeline algorithms, as implemented for the reduction of imaging data, are described elsewhere (Irwin & Lewis, 2001). The basic pipeline consists of the following steps: linearity correction, bias subtraction, flat fielding and the application of a basic astrometric solution. Additional steps in the pipeline are de-fringing, an accurate

astrometric solution, object detection, classification and catalogue generation.

The pipeline can be run in two modes: quick look and science. The goal of the quick look pipeline is to deliver a processed image to the observer within five minutes of image acquisition. This enables immediate assessment of the image quality and instrument performance. The quick look pipeline differs from the science pipeline in two areas: it applies calibration files from the most recent science pipeline run instead of the calibration frames from the current run, and it implements a subset of the full science pipeline reduction, terminating with the de-fringing stage.

The science pipeline provides the observer with reduced data shortly after the end of the observing run. To provide the highest quality data a limited amount of human intervention is necessary, mainly in rejecting poor calibration frames. This pipeline has been running on a Sun® UltraSparc system servicing ING Wide Field Survey Data since August 1998 (Lewis et al., 1999).

2 Powering the Pipeline: Gigawulf

In order to provide an economic processing unit for the pipeline, it was decided to use commodity PC components. Recent advances in the clustering of PC's, making use of the Linux (see e.g. <http://www.linux.com>) operating system have made this feasible. Linux based PC farm's have been found by a number of groups to offer a powerful and cost effective solution for large computational problems. Indeed, a small number of PC systems have been developed for use in astronomical data processing environments (see e.g. Gravitor http://obswww.unige.ch/~pfennige/gravitor/gravitor_e.html).

The ING data pipeline is a coarse grained parallel processing case. To a first approximation, each science data frame is processed in an identical fashion, with no cross reference to any other. Therefore a night's data can be equally distributed between the nodes. PC clusters are ideally suited for this case (see discussion by Brown, 1999, http://www.phy.duke.edu/brama/beowulf_advanced.ps).

Gigawulf is a 'Beowulf' type cluster (<http://www.beowulf.org> for a definition and related links) of eight high end PC's. Each node consists of an AMD Athlon 950 MHz processor with 256 MB of main memory. The seven slave nodes have 30 GB EIDE hard disks while one node, subsequently called the head node, has two 75 GB EIDE hard disks. The head node also has a DDS-3 DAT tape robot as well as a second network card which provides the connection to the telescopes and data archives. The network in the cluster is 100Mbps apart from the head node, which has a Gigabit connection. A schematic view of the system is shown in Figure 1.

To minimise the operational and maintenance overheads, the Scyld Beowulf extension (Scyld Computing Corporation™, <http://www.scyld.com>) to Linux (currently based on RedHat's 6.2 distribution, <http://www.redhat.com>) has been used as the operating system for Gigawulf.

Scyld Beowulf supports standard Linux interfaces and tools. It enhances the Linux kernel with features (provided by bproc, <http://www.beowulf.org/software/bproc.html>) that allow users to start, observe, and control processes on cluster nodes from the cluster's head node. With this arrangement, software only needs to be configured on the head node. The result is that the cluster appears more



like a shared memory multi-processor computer to a user or developer. This reduces the cost of cluster application development, testing, training, and administration.

3 Pipeline Data Flow

The existing pipeline software has been ported to run on Gigawulf with only small modifications. Scripts have been developed to handle the data flow between the telescopes, Gigawulf and archiving media (DVD-R and DDS-3 tape).

During every night run the quick look pipeline is executed. A process running on Gigawulf automatically looks for newly acquired data files. If a new file is found it is copied to the head node. If the file is a calibration frame it is passed on to a slave node. The important point to note in this step is that the same type of calibration image is always transferred to the same slave node. For example, bias frames always go to node 0, B band flat field images to node 1, and so on. More interesting is what happens if the frame is a target frame. The frame is run through the basic pipeline on the head node using pre existing calibration files from the last science run. For filters in which fringing on the CCD occurs the de-fringing algorithm is also run. The

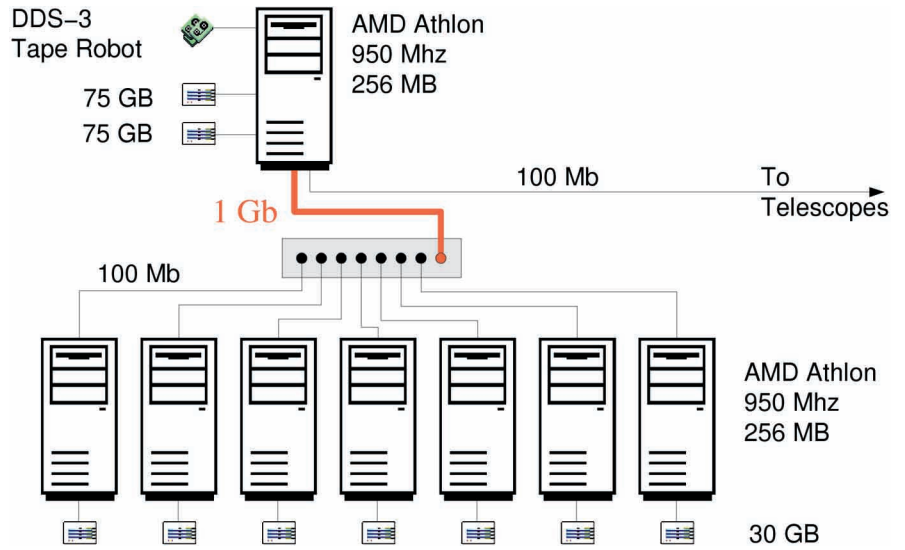

Figure 1. Schematic view of "Gigawulf", a Beowulf cluster consisting of 8 identical high end PCs connected by a high speed network.

fringe frames used are from the last science run as well. Once the image has been processed it is then copied back to the data reduction computer at the telescope where it can be examined by the observer. The original file is then copied to the slave nodes in a round robin fashion. This assures that we have load balancing between the nodes for processing the data with the science pipeline.

At the end of each observing run the calibration images are inspected for quality and bad frames are removed from further processing. The master

bias frame is then assembled on node 0. Once finished, the master bias frame is copied back to the head node, which in turn distributes it to all the other slave nodes. Next the master flat field frames are being calculated. This happens mostly in parallel, as the data files for different filters are located on different nodes. When a slave node finished combining its flat field it sends the result back to the head node, which distributes it among the other slave nodes again. Once all the flat fields have been calculated the full pipeline is run on the target frames. This is a completely parallel process. When all

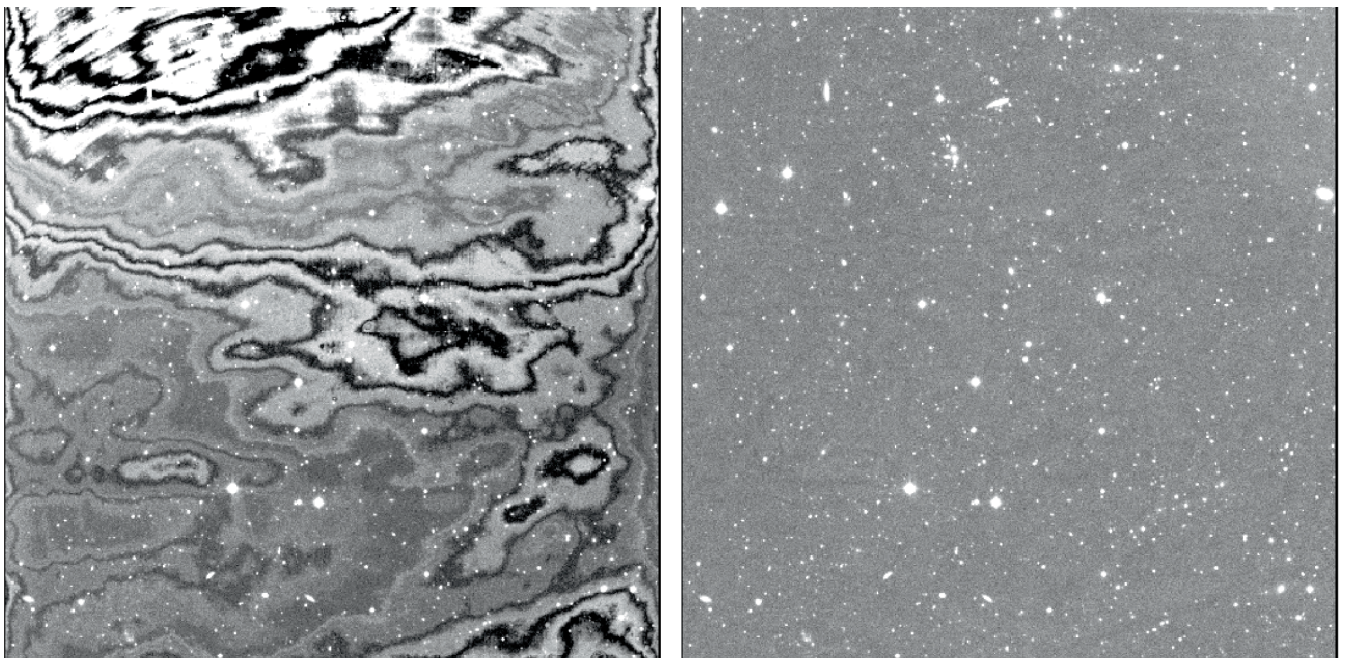

Figure 2. Section of a WFC image before (left) and after (right) de-fringing using Gigawulf.

the nodes have finished processing the data it is then copied back to the head node. The head node writes the data files to DDS-3 tape which are made available to the observer.

Due to the large amount of raw data that is produced by the instruments and the limited data storage capacity on Gigawulf, data cannot be left around after processing for a long time.

The raw and reduced data is removed from the system while the calibration data files and object catalogues are transferred to the CD/DVD towers for ingestion into the data and engineering archive (see news article by Don Carlos, this issue).

4 Current Status and Future Plans

Currently, the pipeline (quick look and science) is implemented for the reduction of optical imaging data from

the WFC and the WHT Prime Focus Camera (PFC). Operation of the quick look and science pipeline processing on Gigawulf was started in February for both cameras. A sample result of the pipeline reduction process can be seen in Figure 2. The image catalogues will also be used for routine quality control enabling for example monitoring of image quality and throughput in near real time.

The imaging pipeline will be extended to handle data from single CCD cameras (WHT Aux Port and JKT) once these systems have been switched over to use UltraDAS (Rixon et al., 2000) which will be done by summer 2001. A pipeline for near infra-red imaging data produced by INGRID is currently being developed and will be deployed in the very near future. A pipeline will also be introduced for Echelle and multi-fibre spectroscopic data by the end of 2001.

A second Beowulf cluster is currently being acquired. One system will then be exclusively used for the WFC pipeline while the other cluster will run the pipelines of the WHT and JKT instruments. This split is basically determined by the amount of data produced by the different instruments available at the ING.

References:

- Irwin, M. J., & Lewis, J. R., 2001, *NewAR* (in press).
 Lewis, J. R., Bunclark, P. S., & Walton, N. A., 1999, in Proceedings of ADASS VIII Conference, *ASP Conf Series*, **172**, 179.
 Rixon, G. T., Walton, N. A., Armstrong, D. B., & Woodhouse, G., 2000, *Proc SPIE*, **4009**, 132.
 Walton, N. A., Lennon, D. J., Greimel, R., Irwin, M. J., Lewis, J. R., Rixon, G. T., 2001, *ING Newsl*, **4** (this issue). ☐

Robert Greimel (greimel@ing.iac.es)

The Second Round of Wide Field Survey Observations

René Rutten (ING)

In July of last year a second call for proposals was sent out, prompting the community in the UK and The Netherlands to submit proposals for survey observations with the Wide Field Camera on the INT. This announcement followed a decision by the ING Board to continue the scheme of survey observations and make available approximately 5 weeks per semester for this work. Survey observations are seen as one of the key roles for the INT and this second call for proposals intends to promote this trend.

The assessment of the proposals this time was left largely in the hands of the UK and NL time allocation panels, who were for the occasion strengthened with two independent assessors. This, it was hoped, would answer the criticism heard in the community during the previous round in 1998. Progress on these proposals will be reviewed annually, based

upon which further allocations will be granted.

As for the previous round, the data will be accessible to the wider astronomical community in the UK and the NL though the ING archive based in Cambridge. There will be no proprietary period in order to promote fast and wide exploitation of the survey data.

From the proposals received, the following six were selected and will be granted observing time:

- The *Oxford Deep WFC Survey*. PI: Dalton (Oxford).
- *Multi-Coloured Large Area Survey of the Virgo Cluster*. PI: Davies (Cardiff).
- The *Faint Sky Variability Survey II*. PI: van den Heuvel (Amsterdam).

- The *INT Wide Angle Survey*. PI: McMahon (Cambridge).
- The *Local Group Census*. PI: Walton (ING, La Palma).
- An *Imaging Programme for the XMM-Newton Serendipitous X-ray Sky Surveys*. PI: Watson (Leicester).

A brief description of each proposal follows:

The *Oxford Deep WFC Survey* also is a continuation of a previous survey proposal. Its principal scientific aim is to study weak lensing by large-scale structure, the angular clustering of faint galaxies, the clustering of Lyman-break galaxies at high redshift and to measure the luminosity function of faint and distant QSOs.

The project *Multi-Coloured Large Area Survey of the Virgo Cluster* will complete the survey that has already



been carried out in the B-band with U, Z and H-alpha images of this galaxy-rich region of the nearby Universe. This will allow determination of the luminosity function as a function of colour and position in the cluster down to luminosities equivalent to the local dwarf spheroidals.

The *Faint Sky Variability Survey II*. is an extension of a programme that was also granted time in previous round. Its aim is to survey 40 square degrees of sky for photometrically and astrometrically variable objects down to 25th mag. The variability domain will be gauged on timescales between tens of minutes to years. Prime targets of this survey are cataclysmic variables and AM CVn stars, RR Lyrae stars, GRBs, high proper motion stars and Kuiper Belt objects.

The *INT Wide Angle Survey*, is also a continuation of an existing survey programme and is the first digital survey over a significant section of the sky (~100 square degree) going significantly deeper than previous sky surveys. Although focussed on three specific observational goals, it will provide a multi-colour general-purpose sky survey that will serve many future studies on 8-m class telescopes.

The *Local Group Census* project will provide a deep narrow band imaging resource of all Local Group galaxies in the Northern Hemisphere. This will enable both old and new emission line populations (e.g. planetary nebulae and luminous blue variables) to be catalogued. Analysis of the population samples across a wide range of galaxy types in the Local Group will shed

light on evolutionary processes. This survey would provide an important resource for spectroscopic follow-up studies with larger telescopes.

The *Imaging Programme for the XMM-Newton Serendipitous X-ray Sky Surveys* will obtain images of some 200 fields drawn from the XMM-Newton observing programme. This will provide an X-ray/optical catalogue of 10,000 to 20,000 sources over 25 square degrees of the sky, which would serve a wide range of astrophysical problems, such as the obscuration of faint AGN population, the evolution of quasar luminosity with redshift, coronal activity on stars, and space density of accreting binary systems. □

René Rутten (rgmr@ing.iac.es)

SCIENCE

High Redshift Quasars in the ING Wide Field Survey

Robert Sharp, Simon Hodgkin, Richard McMahon and Mike Irwin (Institute of Astronomy)

The 2.5m Isaac Newton Telescope (INT) is currently being used to carry out a series of wide field imaging programs under the generic title of the ING Wide Field Survey (WFS) project (McMahon et al., 2000; <http://www.ing.iac.es/Astronomy/science/wfs/>). The Wide Field Camera on the INT consists of a mosaic of four EEV 2k×4k CCD detectors and covers ~0.29 deg² of sky per exposure with a pixel size of 0.33".

The largest of the survey programs is the Wide Angle Survey which aims to observe 100 deg² in a filter set analogous to that used by the Sloan Digital Sky Survey (SDSS u' , g' , r' , i' , z' filters). Some of the survey fields are equatorial to enable complementary observations from telescopes in both hemispheres. All of the survey regions are associated with projects at other wavelengths such as the VLA FIRST radio survey, ISO ELAIS mid-IR and CIRSI near-IR programs, regions from the 2dF redshift survey and XMM X-ray survey fields.

Using an exposure time of 10 minutes per filter the INT WFC reaches 5- σ limiting magnitudes in U_{RGO} , g' , r' , i' and Z_{RGO} of approximately 23, 25, 24, 23 and 22 respectively; bridging the gap between large area shallow surveys such as SDSS (the INT survey goes 2 magnitudes deeper) and deep narrow beam observations such as HDF and the WHT Deep Field (Metcalf, Shanks and Fong, 2000).

The mosaic data from all survey runs is pipeline processed in Cambridge (Irwin and Lewis, 2000; <http://www.ast.cam.ac.uk/wfcsur/>) and involves the following operations: bias-correction and trimming; non-

linearity correction; flat fielding and gain correction; defringing; object catalogue generation; astrometric and photometric calibration; morphological classification of the detected objects; and merging of the object lists from different passbands. A provisional photometric calibration has been applied to the data to the ± 0.05 magnitude level. An improved calibration, making use of overlap regions between adjacent survey pointings, is in preparation.

Hunting for Quasars

For a $z=5$ quasar, the rest frame ultra-violet emission is observed at optical wavelengths (see Figure 1). Forests of neutral hydrogen clouds along the line of sight to the quasar depress the quasar flux blueward of the Lyman- α emission due to resonant

Lyman- α absorption. At shorter wavelengths still, the effect of the Lyman series limit (rest frame 912Å) for sufficiently dense absorbing clouds causes the line of sight to the quasar to become virtually opaque to observations made in a band bluer than the wavelength of the redshifted Lyman series limit.

The strategy for finding a $z=5$ quasar is therefore to search for point sources which are absent in u' and g' images (due to the Lyman series limit), with a large $r'-i'$ colour (suppression of the r' band by the Lyman- α forest) and fairly neutral $i'-z'$ colour (very cool stars and brown dwarfs can generally be distinguished from quasars on the basis of a much redder $i'-z'$ colour).

An area of 12 square degrees was selected from the survey data taken

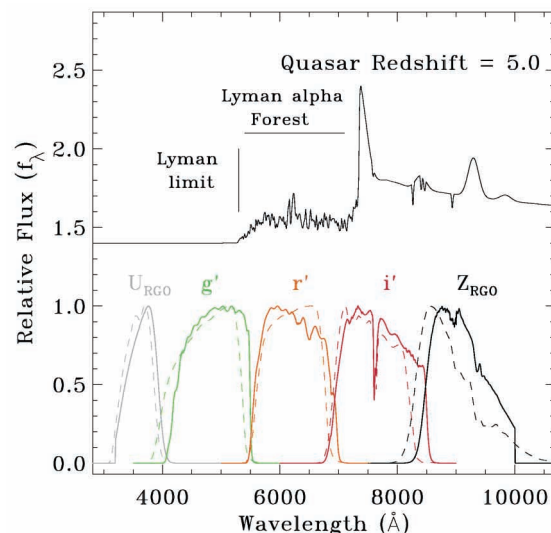

Figure 1. By using a parameterization of the absorption of the intergalactic medium, the colours of high redshift quasars can be simulated to predict which regions of colour space should be searched for quasar candidates. At redshift $z=5$ the Lyman- α emission line (strong in almost all quasar spectra) is in the i' pass band and the Lyman- α forest suppresses the r' band. The object will generally be absent from g' and u' band images. Normalized survey filter responses are also shown; Solid lines — INT filter set; dashed lines — SDSS filter set. A representative CCD response function and atmospheric transparency are included in the filter responses.

between August 1998 and October 1999 which satisfied the following requirements:

- An average seeing of <1.67 arcsec (FWHM of 5 pixels) was required for each acceptable pointing. This defines a practical upper limit for reliable image morphological classification.
- An average stellar ellipticity (due to trailing) of better than <0.2 was required.
- At least g' , r' , i' , z' images must be present and reach to the average $5\text{-}\sigma$ survey depth. The u' filter is only necessary for lower redshift quasars.

Figure 2 shows colour-colour diagrams from INT survey data. Synthetic quasar sequences illustrate how these objects sit apart from the stellar locus. Candidate quasars were selected from these diagrams for spectroscopic follow-up on the William Herschel Telescope.

The current sample has been selected with a quasar candidate magnitude limit of i' or $z' \approx 21$. This limit was chosen to allow useful signal-to-noise spectra to be taken with a 4m-class telescope in 1800 seconds of observation.

WHT Spectroscopic Follow-up

Follow-up observations with the WHT and the ISIS spectrograph were undertaken in June 2000 (Sharp, McMahon, Irwin, Hodgkin in preparation). Only the red arm of the ISIS spectrograph was used as all candidates show very little flux in the bluer passbands. With the R158R grating and the TeK4 CCD the spectral resolution is 2.90\AA per pixel, and we set up to cover the range $6000\text{--}9000\text{\AA}$.

Between $1\text{--}3 \times 900$ second exposures were taken and data were reduced in real time at the telescope to allow on-line identification of candidates. Four high redshift quasars were identified during this run, one of

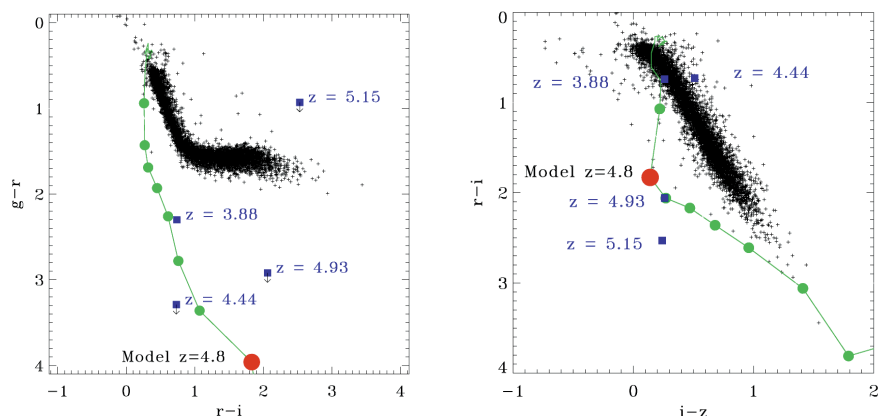

Figure 2. Candidate objects are selected for follow-up observation based on their position in colour-colour diagrams. The main sequence stellar locus is clearly visible in this compilation of high galactic latitude fields observed as part of the INT WFS. Using data from all available pass bands (and investigating three and four dimensional colour spaces) reduces the rate of miss identification due to photometric errors. The inclusion of near IR J or H band photometry aids the separation of quasar candidates from low luminosity M and L dwarfs which are common even in high galactic latitude fields. The four high redshift quasars currently identified in the survey are shown as squares. The three highest redshift objects are not detected in the g' band and are shown as upper limits. A model quasar colour evolution track is overlaid. The circular divisions mark redshift steps of 0.2 from the labeled $z=4.8$ position.

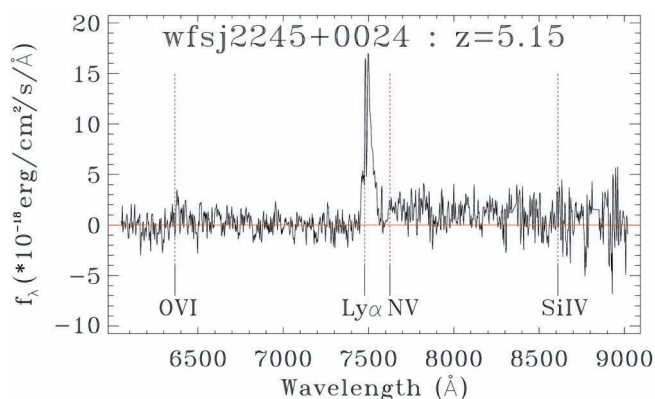

Figure 3. At redshift $z=5.15$, wfsj2245+0024 is the fourth highest redshift quasar known. It was found by the contrast between the red $r'-i'$ colour and the relatively blue $i'-z'$ colour. The strong emission line is Lyman- α and the obvious continuum break across here confirms the identification of this object as a high redshift quasar.

which, wfsj2245+0024, is currently the fourth highest redshift quasar known (see Figure 3).

Summary

This preliminary study has shown that the ING Wide Field Survey is ideally suited to searching for rare faint objects such as high redshift quasars. The work reported here is now being extended to larger areas.

This will enable us to quantify the quasar luminosity function at high

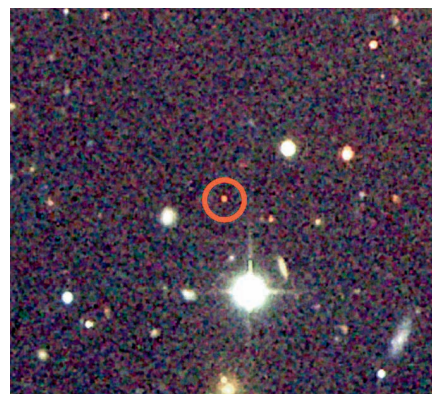

Figure 4. A colour composite image of wfsj2245+0024 made from the INT WFS 600 second exposures in g' , r' and i' . The object was identified as a candidate high redshift ($z>5$) quasar by the red colour.

redshift which in turn will allow a fuller understanding of the contribution of quasars to the extra galactic background light and the re-ionization of the Universe. The faint measurements facilitated by the INT WFS are vital as they help to pin down the shape and normalisation of the faint end of the luminosity function. The region where the luminosity function turns over will delineate those objects that contribute most to the energy budget of the early universe.

We can extend this work to even higher redshifts, i.e. by looking for i' -band dropouts. The detection of even a single quasar at $z > 6$ will allow the Gunn-Peterson measurement to test current predictions for the onset of re-ionization.

References:

- Fan, X. et al., 1999, *AJ*, **118**, 1.
 Fan, X., Strauss, M. A., Schneider, D. P., Gunn, J. E., Lupton, R. H., Anderson, S. F., 2000a, *AJ*, **119**, 1.
 Fan, X. et al., 2000b, *AJ*, **120**, 1167.
 Fan, X., Strauss, M. A., Newman, J. A. et al., 2001, *AJ*, **121**, 31.
 Fan, X., Strauss, M. A., Schneider, D. P., Gunn, J. E., Lupton, R. H., Anderson, S. F., Becker, R. H. et al., 2001, *AJ*, **121**, 54.
 Gunn, J. E., Peterson, B. A., 1965, *ApJ*, **142**, 1633.
 Irwin, M. J., Lewis, J. R., 2000, *New Astronomy Reviews* (in press).
 McMahon, Walton, Irwin, Lewis, Bunclark, Jones and Sharp, 2000, astro-ph/0001285.
 Metcalfe, N., Shanks, T., Fong, R., 2000, *ING Newsl*, **3**, 3.
 Schmidt, M., Schneider, D. P., Gunn, J. E., 1995, *AJ*, **110**, 68.
 Sharp, R. G., McMahon, R. G., Irwin, M. J., Hodgkin, S. T., 2001, astro-ph/0103079.
 Stern, D., Spinrad, H., Eisenhardt, P., Bunker, A. J., Dawson, S., Stanford, S. A., Elston, R., 2000, *ApJ*, **533**, L75.
 Warren, S. J., Hewett, P. C., Osmer, P. S., 1994, *ApJ*, **421**, 412.
 Zheng, W. et al., 2000, *AJ*, **120**, 1607. □

Robert Sharp (rgs@ast.cam.ac.uk)

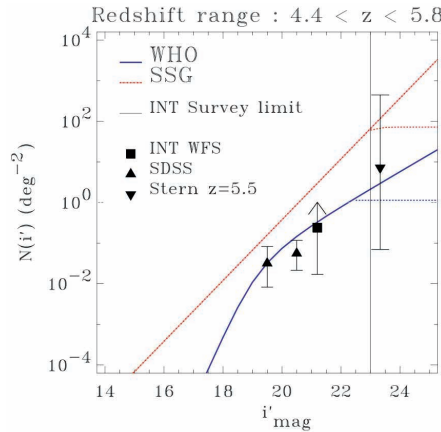

Figure 5. The comparison between two integrated quasar luminosity functions shows the extent of the current uncertainty over the redshift range for which the riz selection technique is sensitive. There is an order of magnitude discrepancy between the extrapolations of these two parameterizations in the apparent magnitude range where most of the energy is contributed to the ionizing background light. SSG — Schmidt, Schneider, Gunn, 1995, *AJ*, **110**, 68; WHO — Warren, Hewett, Osmer, 1994, *ApJ*, **427**, 412.

Name	z	Mag.			Ref.
		r'	i'	z'	
wfsj2245.6+0024	5.15	23.96	21.43	21.19	1
wfsj1612.7+5255	4.90	22.21	20.15	19.89	1
SDSS 1044-0125	5.80	>22.83	21.40	18.67	2
RD J0301+0020	5.50	26.2	23.38	22.84	3
SDSSp J1208+0010	5.27	22.66	20.37	20.17	4
SDSSp J1204-0021	5.03	20.72	18.89	18.56	5
SDSSp J0338+0021	5.00	21.61	19.54	19.19	6
SDSSp J1605-0112	4.92	22.42	19.36	19.37	5
SDSSp J0211-0009	4.9	21.97	19.51	19.26	6

Table 1. Known high redshift ($z > 4.9$) quasars. Refs.: 1. Sharp et al., 2001; 2. Fan et al., 2000b; 3. Stern et al., 2000; 4. Zheng et al., 2000; 5. Fan et al., 2000a; 6. Fan et al., 1999.

Scientific Impact of Large Telescopes

Chris Benn and Sebastián Sánchez (ING)

Some telescopes clearly have higher scientific impact than others, but there have been few attempts to quantify this, or to compare impact with cost. Are 4-m telescopes a better investment than 2-m telescopes? Are space telescopes as cost-effective as ground-based telescopes? Recently, we obtained, from the Institute of Scientific Information (ISI), Philadelphia, a list of the 1000 most-cited astronomy papers published worldwide during 1991–8 (the top 125 papers each year). Although high citation isn't an infallible guide to scientific impact, and citation counts are subject to a number of biases (e.g. UK/US astronomers tend not to cite foreign-language publications), most of the hottest new science of the last decade

will be represented in this sample of papers. We determined which telescopes were used to obtain the data on which each of these papers was based, and thus measured the impact (fraction of total citations generated) of each telescope averaged over 1991–4 and 1995–8.

The impacts of ground-based optical telescopes are shown as a function of mirror diameter in Figure 1, and the 1991–4 and 1995–8 impacts are compared in Figure 2. Amongst 4-m class telescopes, CFHT has the highest impact, with the WHT in second place, but the differences between individual telescopes are small. Keck I, in use since 1993, has an impact 8 times larger than that of typical 4-m telescopes, and this factor is similar

to the ratio of collecting areas. No papers from other 8-m–10-m telescopes (apart from Keck II, commissioned 1996) appear in the list, since most were commissioned after 1998. The mean impact of 2-m class telescopes is a factor ~ 4 lower than that of 4-m telescopes, again consistent with the ratio of collecting areas. Comparison of individual 2-m telescopes is difficult because the numbers of papers involved are small.

The citation shares of different types of telescope are compared in Figure 3. 1-m and 2-m telescopes together contributed half as much science as 4-m telescopes during 1991–8. Three of the top 40 most-cited papers 1991–8 are based on data from 1-m telescopes only, including two from the microlensing survey carried out with the Mt. Stromlo 1.3-m. Extrasolar planets were also discovered using a small telescope: the Haute Provence 1.9-m (Mayor & Queloz, 1995, the 9th most-cited paper of that year).

The year-2000 capital costs of 2-m, 4-m and 10-m class telescopes are $\sim \$5\text{M}$, $\$18\text{M}$ and $\$80\text{M}$, while the impacts are in the approximate ratio 1:3:25 (Figure 1). If one assumes that running costs scale roughly as capital cost (Abt, 1980), then the data of Figure 1 indicate that 2-m telescopes are roughly as cost-effective as 4-m telescopes. Keck I is twice as cost-effective, but is the first of its size, and may have a bigger scientific impact than any of the 11 8-m–10-m telescopes now coming online: 4 VLT, 2 Gemini, Subaru, LBT, HET, SALT and GranTeCan.

Notably productive non-optical telescopes (Figure 2) include JCMT (\sim twice the impact of a typical 4-m, largely thanks to SCUBA), IRAM and the VLA. The space telescopes ASCA, BeppoSax, CGRO, COBE, Hipparcos, ROSAT all have impacts ~ 4 times higher than a 4-m telescope, but cost $\sim 15\text{--}30$ times as much. Comparison of the cost-effectiveness of ground-based and space telescopes is not straightforward. Some space telescopes (e.g. COBE, Hipparcos) are launched to solve a specific scientific problem which can't be tackled from the

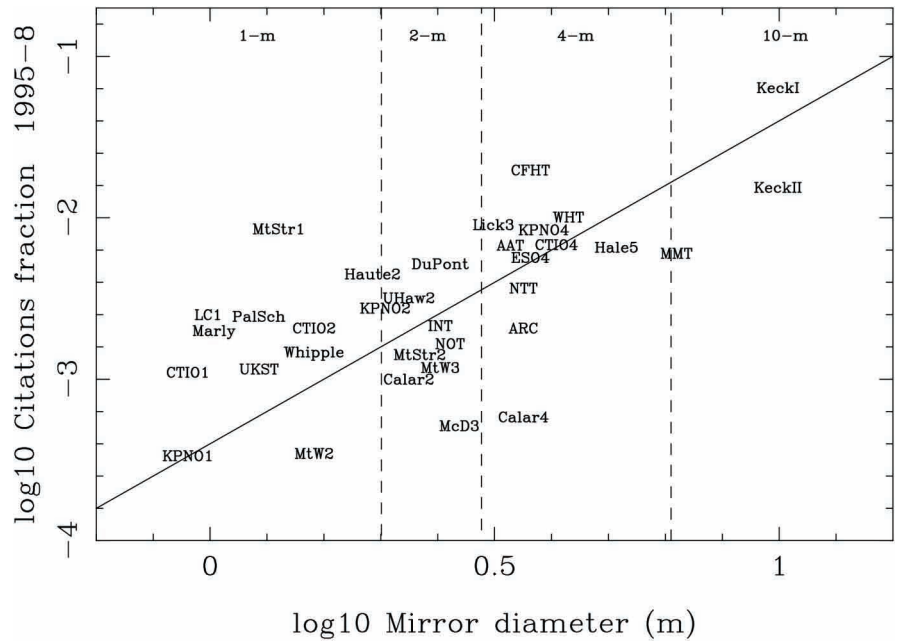

Figure 1. Citations fraction 1995–8 vs telescope diameter, for ground-based optical telescopes. Most of these telescopes were in use throughout 1991–8. The straight line indicates citation fraction = $0.6\% \times (\text{diameter}/4\text{ m})^2$. Statistical errors $N_{\text{papers}}^{-0.5}$ are ~ 0.2 in \log_{10} for typical 4-m telescopes, ~ 0.3 for 2-m. In this figure, and Figure 2, a few points have been displaced slightly to avoid overlap of labels. Digits suffixed to the abbreviations distinguish telescopes of different size at the same observatory.

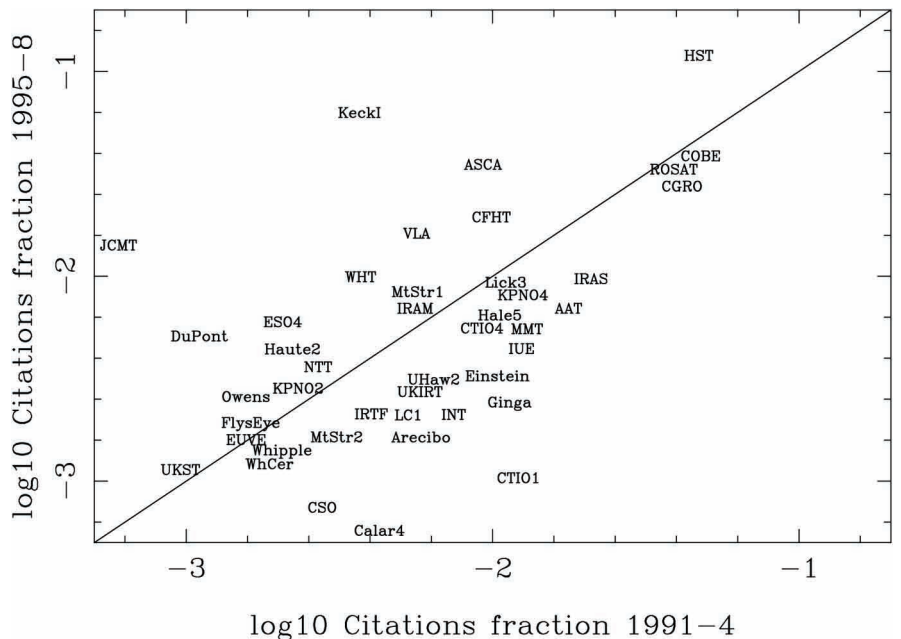

Figure 2. Citations fraction 1995–8 vs 1991–4, for both ground-based and space telescopes. The straight line has slope 1. Only telescopes with significant impact in both 1991–4 and 1995–8 appear on the plot (e.g. BeppoSax, Hipparcos, ISO, KeckII, RXTE, and SOHO all have citation fractions $> 1\%$ in 1995–8, but zero in 1991–4).

ground and they may have a short-lived community of citers, so it's not clear that citation counts are a fair measure of scientific impact. Others, such as HST, compete more directly with ground-based facilities (particularly now, with the advent of adaptive optics), and can be used to

tackle similar problems, so a citation-based comparison of cost-effectiveness is fairer. HST, launched in 1990, generated 15 times as many citations as a typical 4-m telescope but cost ~ 100 times as much, $\sim \$2000\text{M}$ (much more, if the cost of servicing missions is taken into account).

For an independent measure of scientific impact, we repeated the above analysis using the 452 observational astronomy papers published in *Nature* 1989–98, reasoning that only papers of the highest scientific merit make it into *Nature*. We found a close correlation between citation fraction and count of papers in *Nature*, except that radio telescopes are over-represented in *Nature* by a factor >3 relative to optical telescopes (or, to put it another way, radio telescopes are under-represented in the citation counts). This discrepancy highlights the risk of incurring metric-specific biases when comparing the scientific impacts of different kinds of telescope or community. The numbers of *Nature* papers generated by ground-based optical telescopes during 1989-98 are compared in Figure 4. The WHT was the most productive ground-based optical telescope during this period.

For each of the highest-cited and *Nature* papers generated by the WHT, we checked the instrumentation used. During most of 1991–8, observers were offered a choice of between 6 and 8 instruments at the WHT. However, 28 of the 31 WHT papers used data obtained with the intermediate-resolution spectrograph ISIS (21) or with an optical imaging camera (7).

The list of the 1000 most-cited papers can also be used to break down scientific impact by region, subject, journal or host institution (of first author). 61% of the citations to the 1000 most-cited papers are to papers with first authors at US institutions, 11% UK, 20% European (non-UK) and 8% other (mainly Australia, Canada, Japan). 52% of the citations are to extragalactic papers, 34% stellar/galactic, 7% solar-system, 7% technical. At 4-m telescopes whose users are predominantly from North America or the UK, 75% of the cited papers (and 29 of the 34 Keck papers) are on extragalactic topics. For European (non-UK) 4-m telescopes, the fraction is 44%. The shares of the citation count by journal are: *ApJ* 44%, *MNRAS* 9%, *A&A/S* 10%, *Nature* 11%, others 26%. The most-cited host institutions in the UK

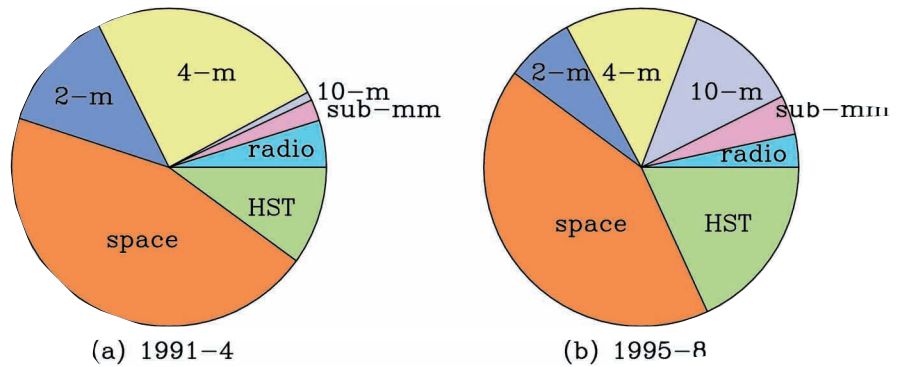

Figure 3. Citation shares of different types of telescopes, for 1991–4 and 1995–8. ‘2-m’ in this figure includes both 1-m and 2-m class telescopes.

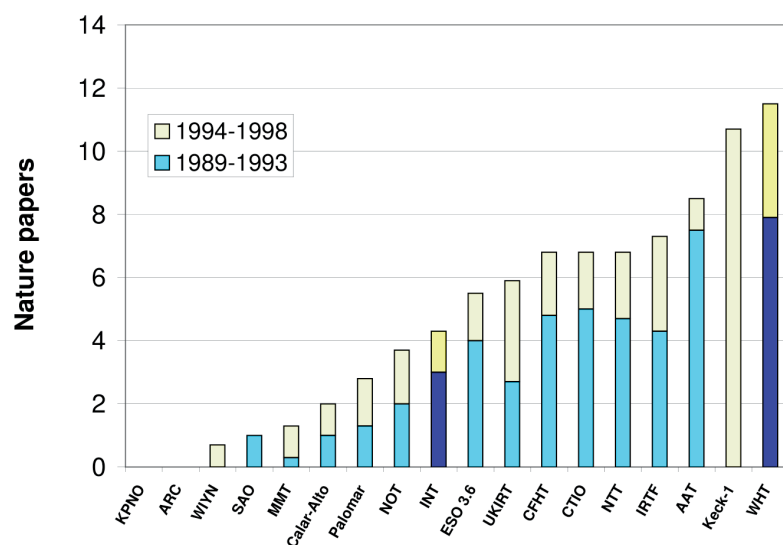

Figure 4. Number of *Nature* papers generated 1989–98 by ground-based optical telescopes with mirror diameter >3.5 m (for comparison, figures for the 2.5-m INT and Nordic Optical Telescope are also included).

were IoA Cambridge and Durham (with Durham creeping ahead in 1995–8).

Perhaps our most interesting conclusion is that during 1991–8, the era of 4-m telescopes, a substantial fraction of the science was generated by 1-m and 2-m telescopes (Figure 3). This strong showing by small optical telescopes suggests that cutting-edge science doesn’t always require the largest aperture available, and this augurs well for the continued scientific impact of 4-m telescopes in the era of 8-m telescopes.

For further statistics, and full details of the analysis, see our article in press at *PASP* (Benn & Sánchez, 2001). A recent feature article in *Nature* (2000) discusses these results further. We

thank ING summer students Ed Hawkins, Samantha Rix and Dan Bramich for their help with this project.

References:

- Abt, H. A., 1980, *PASP*, **92**, 249.
 Benn C. R., Sánchez S. F., 2001, *PASP*, in press. Available at astro-ph/0010304.
 Mayor, M., Queloz, D., 1995, *Nature*, 378, 355.
Nature, 2000, **408**, 12. □

Chris Benn (crb@ing.iac.es)

Normal and Eccentric Dying Suns

Romano L. M. Corradi (ING)*

*: *Romano is a Research Fellow at ING.*

In recent years, a lot of effort has been put into better understanding the physical processes which lead a sunlike star, at the end of its evolution, to lose its gaseous envelope and die as a slowly cooling white dwarf. The most spectacular phase of this late evolution is the one in which the ejected envelope is made fluorescent by the energetic radiation from the naked stellar core, in which the last thermonuclear reactions take place. These ionised nebulae, historically (and misleadingly) called ‘planetary nebulae’, are among the most beautiful objects in the Universe, and are the key to understanding phenomena which are relevant to many fields of astrophysics and particle physics.

One of the modern problems covered by the study of planetary nebulae (hereafter PNe) is the dynamical evolution of the gas ejected by the star, and the consequent formation of the amazingly wide variety of large- and small-scale morphological structures which are observed. We know that the dynamical evolution of a PN is governed by the following processes:

1. The mass loss history from its progenitor, a pulsating red-giant star moving along the Asymptotic Giant Branch (AGB) towards very high luminosities (10^3 – $10^4 L_{\text{sun}}$). This includes the time variation of the mass loss rate, which is believed to be modulated by repeated helium-shell flashes (thermal pulses) occurring in the stellar interior; the geometry of the mass loss; and the hydrodynamical evolution of this slowly expanding wind ($V=10$ km/s, $M=10^{-4}$ – $10^{-5} M_{\text{sun}}/\text{yr}$);
2. The energetic radiation from the stellar remnant after the envelope ejection. Photons not only ionise the envelope, but also have notable dynamical effects: moving ionisation/

recombination fronts create temperature and pressure discontinuities which result in shock waves forcing redistribution and acceleration of the outflowing gas;

3. A hypersonic wind ($V=\text{several } 10^3$ km/s, $M=10^{-9} M_{\text{sun}}/\text{yr}$) blown from the stellar remnant during its high luminosity and high temperature post-AGB phase. This fast wind quickly reaches the regions occupied by the former, slower and denser AGB wind and drives into it a strong shock wave;
4. The interaction with the surrounding interstellar medium.

All these processes must be taken into account when trying to reproduce the observations of real PNe. In addition, they must be treated in a time-dependent way, since the properties of winds and radiation from the central star vary on short timescales owing to its very rapid post-AGB evolution. In spite of these difficulties, nowadays sophisticated radiative/hydrodynamical models that take into account all the processes above are available in 1-D, 2-D, or even 3-D (e.g. Marten & Schonberner, 1991, Mellema, 1995). A detailed comparison with the

observations is therefore possible, and it is along this line that a good fraction of my recent research has been directed. The study has taken advantage of many observational facilities worldwide: for imaging, the 2.5-m NOT at ORM, the 3.5-m NTT at ESO, and the HST. For the kinematical studies, the NTT, the NOT and the 4.2-m William Herschel Telescope with its echelle spectrograph UES. Some results are schematically illustrated in the next sections.

‘Normality’: Spherical Shells for Stellar Paleontology

It is nowadays known that the classical model of PNe as spherical expanding shells applies to only 10–20% of all known Galactic PNe. NGC 2438 is one of those. We have obtained deep narrow-band images and echelle spectra of this rather old PN, revealing the existence of two giant haloes surrounding the main body of the nebula (Corradi et al., 2000a, see Figure 1). Hydrodynamical modelling of these data shows that NGC 2438 is an excellent case to illustrate the

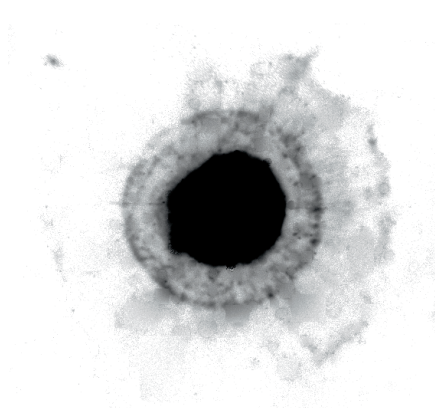
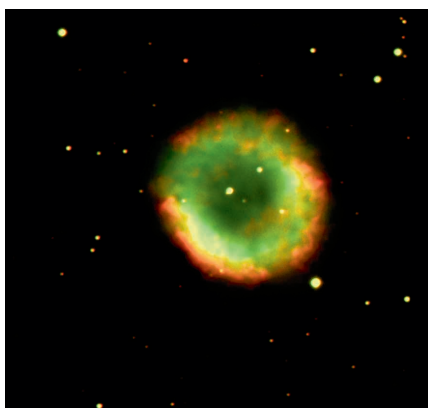

Figure 1. Left: Color-composite image of the inner nebula of NGC 2438. Green is the [O III] emission at $\lambda 5007\text{\AA}$, red is the hydrogen H-alpha and [N II] emission at $\lambda 6562\text{\AA}$ and 6583\AA , respectively. Right: The outer haloes of NGC 2438. In this deep image, the inner nebula is saturated and corresponds to the black central region.

effects of most of the physical processes mentioned before.

The inner, bright nebula of NGC 2438 (Figure 1, left) is the result of the dynamical action of the fast post-AGB wind (point 3 above), shocking and compressing the preexisting AGB wind into a bright hollow shell.

The outermost, very faint halo (Figure 1, right) is interpreted as being the relic of the original AGB wind, still unaffected by the fast post-AGB wind (point 1). We speculate that the ridge of this halo is the signature of the last thermal pulse on the AGB and occurred about 50000 yrs ago.

However the intermediate halo turns out instead to be a 'false' one, i.e. is not the remnant of a sudden increase of mass loss in the red giant progenitor (i.e. of a thermal pulse), but is just a dynamical effect of the radiation from the central star (point 2). From our hydrodynamical modelling, we conclude that it was in fact formed by recombination from the once ionised outer gas in response to a fast luminosity drop of the central star. Thermonuclear burning on the central star stopped a few thousand years ago, and its luminosity has rapidly decreased by a factor of ten. Due to the consequent lack of ionising photons, part of the gas forming the PN has recombined. The shock associated with the recombination front makes the region collapse into a thin, high-density shell, which looks like the ridge of a real halo (but is not!).

Thus the study of NGC 2438 confirms that PN haloes potentially offer a way to recover the occurrence and time-scales of the AGB thermal pulses, i.e. the mass loss history from the red giant progenitors of PNe, but only provided that a correct hydrodynamical analysis is performed.

'Eccentricity' 1: Lobes and Jets

At variance with NGC 2438, a notable fraction of PNe show highly collimated nebulae, in the form of bipolar pairs

of lobes or even narrow jets. What is collimating these outflows?¹

Hydrodynamical-inertial collimation forced by equatorial discs or torii surrounding the stars can explain the formation of bipolar lobes (e.g. Mellema, 1995). The origin of these confining torii is controversial, although the presence of a stellar companion appears in many cases the natural way to produce them, either by gravitational focusing of the stellar wind toward the orbital plane, or by spinning up the envelope of the mass-losing star (Soker & Rappaport, 2000). For the highest collimation observed, such as the highly bipolar PN K 4–47 (Figure 2, Corradi et al., 2000b), magneto-hydrodynamical mechanisms are often invoked, with or without the presence of accretion discs.

'Eccentricity' 2: Microstructures

Many PNe show enigmatic small-scale structures, usually observed in the light of low-ionisation species such as [NII] or [OI]. They are found in the form of knots, tails, ansae, filaments, serpentine, jets, jet-like structures... (the nomenclature used in the literature is intimidating) attached to or detached from the main bodies of the PNe. The origin of many of these structures, such as the low-velocity but highly-collimated structures

observed in several PNe, is puzzling (cf. Gonçalves et al., 2001). Other ones can be associated to the development of dynamical (Kelvin-Helmholtz and Rayleigh-Taylor) and radiative instabilities during the PN evolution. Examples of two PNe containing this kind of low-ionisation small-scale structures are given in Figure 3 (from Corradi et al., 1999).

'Eccentricity' 3: A Nebular Corkscrew

M 2–9 (Figure 4) is a special case in the already special class of bipolar PNe. Contrary to most of bipolar PNe, it has a low temperature central star, unusually low N and He chemical abundances, peculiar dusty jets which are seen only as reflected light (Schwarz et al., 1997), and a unique rotating emission pattern that we have recently studied by collecting CCD images over a period of 15 yrs (Doyle et al., 2000). These images show that the morphological changes resemble a

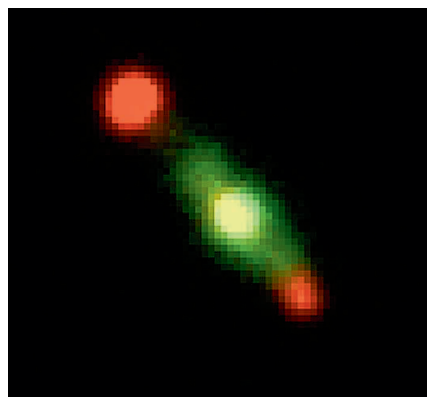

Figure 2. The highly collimated PN K4–47. Green is [OIII], red is [NII].

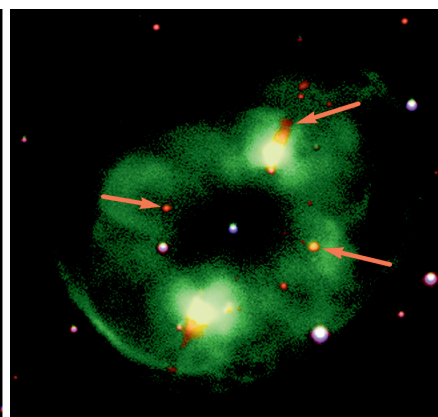
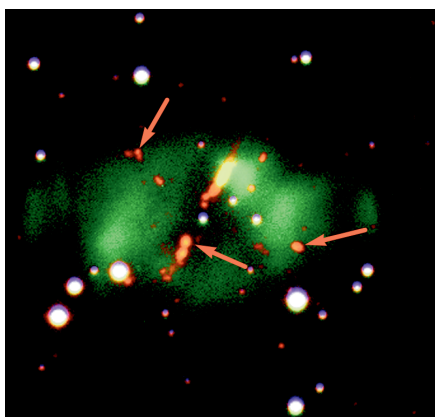

Figure 3. The PNe K1–2 (left) and Wray 17–1 (right). Green is [OIII], red is [NII]. The low-ionisation microstructure discussed in the text are the red features indicated by red arrows.

¹: The fraction of bipolar PNe is similar to the fraction of spherical ones. What is then 'normal' and what 'eccentric'?

rotating corkscrew-like pattern, as if a precessing particle beam flowing with a speed of several 1000 km/s (a 'spray') shock-heats and ionises the walls of the main bipolar lobes of the nebula. The rotation period of the pattern is about 120 yrs. A gif animation can be found at:

<http://cdsaas.u-strasbg.fr:2001/AJ/journal/issues/v119n3/990457/990457.html>

It seems unavoidable to invoke the presence of an interacting stellar companion to produce such a rotating spray of particles. This would also provide an easier way to collimate the main bipolar outflow. No observational evidence for binarity, however, has been found yet.

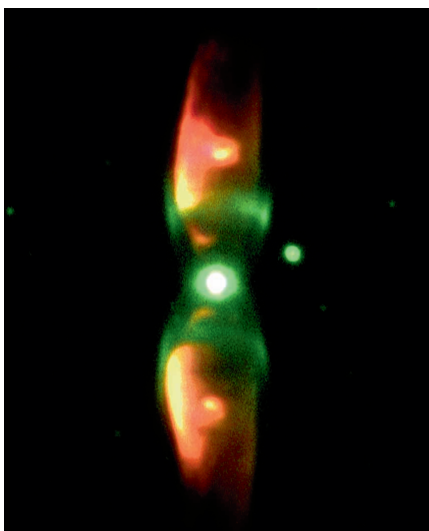

Figure 4. The "Butterfly" Nebula M 2-9. Green is [OIII], red is [NII].

'Eccentricity' 4: Stellar Symbiosis

The existence of a stellar companion is certainly known for the case of the symbiotic Mira He 2-104, a brilliant example of the kind of mass loss that one would expect during the late AGB if a white dwarf companion is present at a moderate distance (some 10 AU). The nebula around He 2-104, named the 'Southern Crab' for its characteristic morphology, was discovered by Schwarz et al. (1989). Recently, we have obtained HST images (Figure 5) and ground-based echelle spectra to study its dynamics (Corradi et al., 2001).

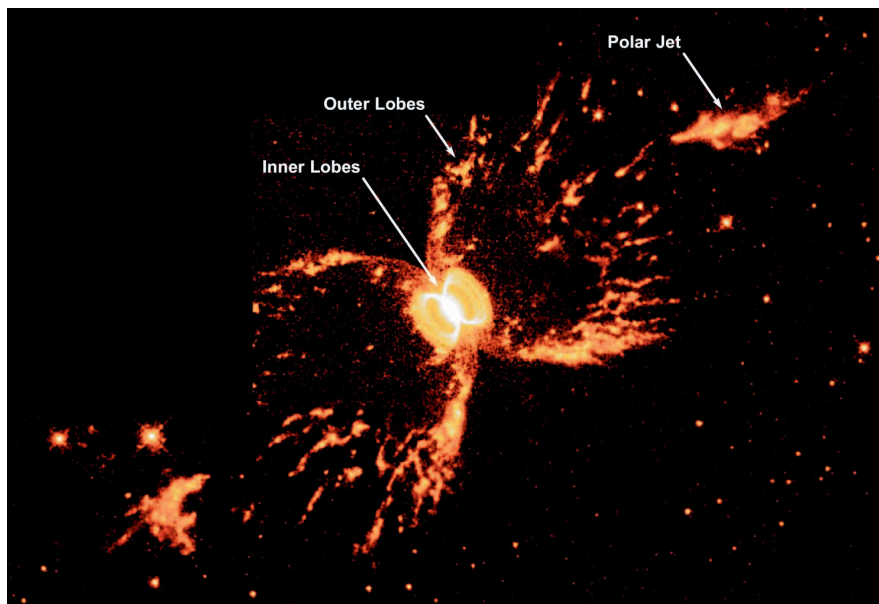

Figure 5. HST [NII] image of the symbiotic nebula He 2-104, the "Southern Crab".

The nebula is composed of two nested pairs of lobes and symmetrical polar jets. Surprisingly, the new data no longer support our previous idea that the nested bipolar nebulae of He 2-104 are the result of two 'identical' mass loss events from the white dwarf companion of the Mira, produced during two similar nova-like outbursts separated by some thousand years. The echelle spectra show in fact that the inner pair of lobes is expanding with velocities one order of magnitude lower than the outer pair, and modelling shows that the kinematical age of the two outflows is the same (and also coincides with the age of the polar jets)! Thus all three different outflows from He 2-104 are coeval, within the observational uncertainties, and were produced about 5000 yrs ago. We present a new model in which enhanced mass loss from the Mira, possibly following a thermal pulse, triggers activity on the white dwarf companion, the formation of an accretion disc and concomitant high velocity outflows forming the outer pair of lobes and jets. The inner, slowly expanding lobes would instead be produced by the enhanced Mira wind itself. For both pairs of lobes, the collimating 'nozzle' would be a circumbinary massive torus of gas produced by the Mira wind during a previous, long period of more quiescent mass loss, and focussed onto the orbital plane by the gravitational effects of the companion.

A conference on symbiotic stars is being organised by the ING and will be held on La Palma on May 2002. I expect that this will be the occasion to strengthen the belief that shaping mechanisms of the type discussed for He 2-104 may be operating in many PNe and related objects, such as novae, supernovae and young stars.

References:

- Corradi, R. L. M., Perinotto, M., Villaver, E., Mampaso, A., Goncalves, D. R., 1999, *ApJ*, **523**, 721.
- Corradi, R. L. M., Schonberner, D., Steffen, M. & Perinotto, M., 2000a, *A&A*, **354**, 1071.
- Corradi, R. L. M., Villaver, E., Mampaso, A., Goncalves, D. R., Perinotto, M., Schwarz, H. E. & Zanin, C., 2000b, *ApJ*, **535**, 823.
- Corradi, R. L. M., Livio, M., Balick, B., Munari, U. & Schwarz, H. E., 2001, *ApJ*, in press.
- Doyle, S., Balick, B., Corradi, R. L. M. & Schwarz, H. E., 2000, *AJ*, **119**, 1339.
- Goncalves, D. R., Corradi, R. L. M., Mampaso, A., 2001, *ApJ*, in press.
- Marten, H., Schonberner, D., 1991, *A&A*, **248**, 590.
- Mellema, G., 1995, *MNRAS*, **277**, 173.
- Schwarz, H. E., Aspin, C., Lutz, J. H., 1989, *ApJ*, **344**, L29.
- Schwarz, H. E., Aspin, C., Corradi, R. L. M. & Reipurth, B., 1997, *A&A*, **319**, 267.
- Soker, N. & Rappaport, S., 2000, *ApJ*, **538**, 241. □

TELESCOPES AND INSTRUMENTATION

NAOMI – Adaptive Optics at the WHT

Chris Benn (ING), Andy Longmore (ATC), Richard Myers (Univ. of Durham), Tom Gregory (ING), Clive Davenhall (IoA)

NAOMI is mounted at the WHT's GHRIL Nasmyth focus, and delivers near-diffraction-limited images, $\text{FWHM} \leq 0.2$ arcsec, to the IR camera INGRID. NAOMI had its first commissioning run in August/September 2000. An image from that run is shown at right. Most of the remaining commissioning work will be completed off-sky before the May/June 2001 commissioning nights, which will be used principally for characterising on-sky performance.

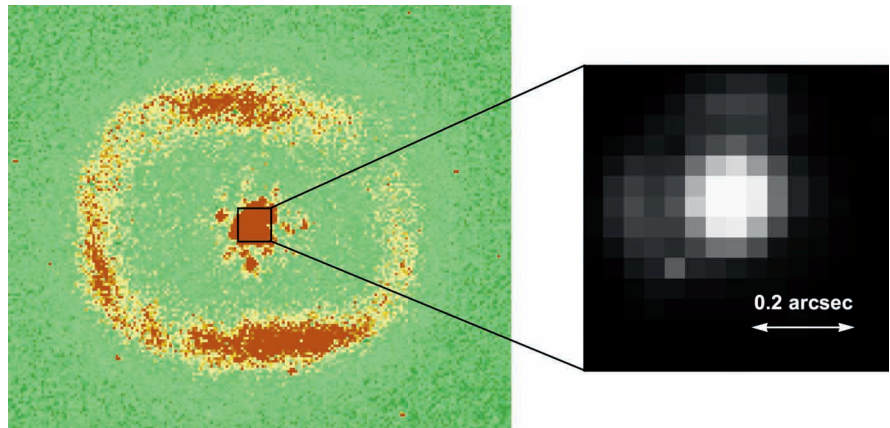

Figure 1. On the left: a 90-sec K-band commissioning image of planetary nebula BD 303369 (nebula diameter 3.8 arcsec top to bottom). The blobs around the central (guide) star are $\sim 1\%$ residuals in the PSF. On the right: enlargement of area around the central star, $\text{FWHM} 0.13$ arcsec. Parts of the first diffraction ring are just visible.

NAOMI/INGRID is offered in semester 2001B on a shared-risks basis, for the period August – November 2001 (other instruments will be mounted on the GHRIL Nasmyth platform during December and January). The observing will be carried out in service mode. NAOMI can be used to image any astronomical target which has a suitable guide star nearby. AO systems at other large telescopes (CFHT, Gemini, Keck I) have been used to study a wide variety of objects, including comets, binary asteroids, circumstellar disks, dwarf galaxies, AGN, QSO hosts and gravitational lenses.

Table 1 shows predictions (based on models by Ron Humphries and Richard Wilson, Durham) of NAOMI's performance as a function of guide-star magnitude, wavelength band and uncorrected seeing. Performance is given in terms of 'Strehl ratio', the ratio between the peak heights of the corrected and diffraction-limited point-spread functions.

For Strehl ratios of more than a few tenths, the bulk of the light will be concentrated in a diffraction-limited core ($\text{FWHM} \sim 0.12$ arcsec in K), with the remainder of the light distributed

Guide-star V mag	Band	Strehl in seeing			FWHM (")
		1.0 (")	0.7 (")	0.5 (")	
11	K	0.46	0.62	0.69	0.12
12	K	0.34	0.51	0.61	
13	K	0.19	0.38	0.50	
14	K	0.06	0.21	0.35	
11	H	0.29	0.45	0.54	0.08
12	H	0.19	0.36	0.46	
13	H	0.08	0.24	0.35	
14	H	0.02	0.10	0.21	
11	J	0.15	0.29	0.38	0.07
12	J	0.08	0.21	0.31	
13	J	0.03	0.12	0.22	
14	J	0.01	0.04	0.11	

Table 1. NAOMI's predicted performance as a function of guide-star magnitude, wavelength band and (uncorrected) natural seeing. The last column shows the corrected FWHM.

over the (uncorrected) natural-seeing disk. With poorer AO correction, there will still be a diffraction-limited core, but it will contain only a small fraction of the light.

Strehl ratio is predicted to fall to half its on-axis value at radii 13, 17 and 23 arcsec respectively in J, H and K bands (the size of the anisoplanatic patch scales as $\text{wavelength}^{6/5}$). That is, for a given degree of correction, the guide star needs to be closer to the target for J and H imaging than for K.

The sky coverage, i.e. the fraction of sky falling within the anisoplanatic patch of a bright star, depends on required Strehl, and on galactic latitude. In K band, for delivered Strehl 0.3, sky coverage is $\sim 10\%$ at galactic latitude 30° .

The guide star can be the target itself, if sufficiently bright and pointlike ($\text{FWHM} < 1.5$ arcsec). There should be no stars of similar magnitude within ~ 5 arcsec of the guide star.

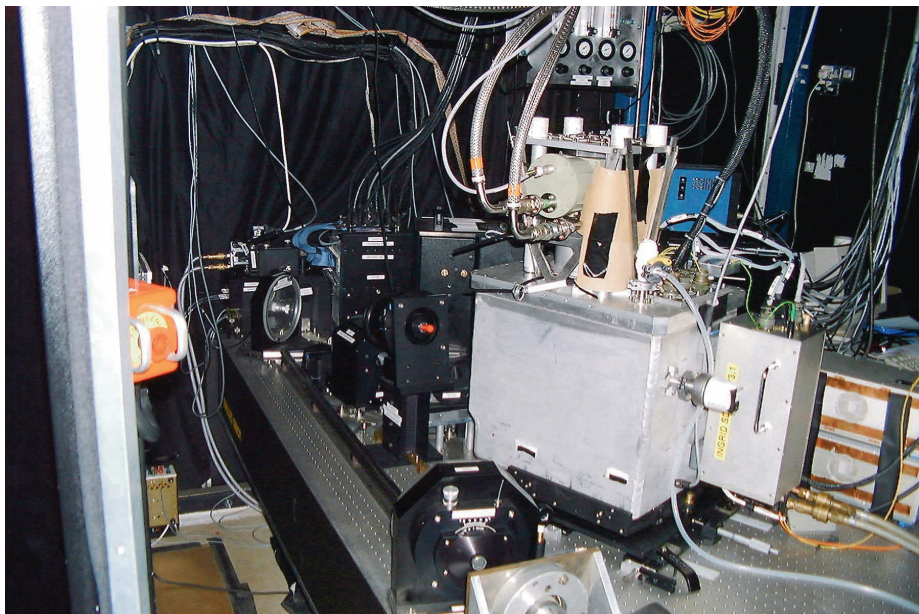

Figure 2. NAOMI in GHRIL, during commissioning August and September 2000. The large box in the foreground is INGRID.

The scale at INGRID is 0.04 arcsec/pixel, field of view 40 arcsec. The sky background in J and H is similar to that measured with INGRID mounted at the Cassegrain focus. The K thermal background has yet to be determined (see the ING NAOMI web page for the latest information). Throughput to INGRID with NAOMI is about 0.5 times that to INGRID mounted at Cassegrain (due to losses in the GHRIL derotator, and in the NAOMI optics). Signal-to-noise predictions can be made using SIGNAL, the ING signal-to-noise calculator.

Observing overheads with adaptive-optics systems are higher than for normal observing. For acquisition of the guide star by the wavefront sensor, observers should allow 5 – 10 minutes per target. Additional time should be allowed for calibration of the point-spread function (PSF), if required. The PSF delivered by an AO system is a function of radius from the guide star, but can be estimated by observing star pairs of similar separation (to the guide star and target) at frequent intervals during the night (~ every half hour). For extended targets, offset sky exposures will also be required (as for normal IR observing). INGRID itself takes only ~1 sec to read out.

With planned enhancements to the way the wavefront-sensor CCDs are read, the eventual guide-star limit for

NAOMI will be ~1 mag fainter than quoted in Table 1. In the longer term, the use of ‘zero-noise’ CCDs in the wavefront sensor offers another potential gain. Each 1-mag increase in the guide-star limit corresponds to a factor of 3 increase in sky coverage.

NAOMI currently feeds only the IR imager INGRID, but its real strength, compared with other AO systems, is expected to be its performance at shorter wavelengths. From late 2002 NAOMI will feed the integral-field optical spectrograph OASIS (formerly at CFHT), and an optical imaging camera is also planned. A coronagraph is being designed, and this will feed either the IR or optical imager (~spring 2002), or OASIS for spectroscopy (~spring 2003).

NAOMI has arrived! Observers are encouraged to apply to use it in semester 2001B. For technical details, and further information on using NAOMI, see the ING NAOMI web page at <http://www.ing.iac.es/~crb/wht/ao.html>, or email one of the authors below.

Searching for NAOMI Guide Stars

Observations made with the NAOMI adaptive optics system usually require a guide star located close to the target object being observed. The NAOS

package is available to assist in finding such guide stars. You prepare a list of target objects and NAOS remotely searches a version of the USNO PMM astrometric catalogue to find suitable guide stars for these targets. NAOS is fully documented in the manual SUN/235, which comes with the package. NAOS will be included on the Starlink CD-ROM to be released in the summer of 2001. In order to make NAOS available sooner a copy will be available in the Starlink Software Store no later than Monday 12 March 2001. In order to retrieve a copy from the Software Store go to URL:

<http://www.starlink.rl.ac.uk/cgi-store/storetop>

and follow the links ‘full list of available software’ and ‘Applications and User Interfaces’. Then click on the entry for ‘NAOS’. If you have any queries about NAOS, or encounter any difficulty in using it, then please send an e-mail message to: cursa@star.rl.ac.uk. ☐

Chris Benn (crb@ing.iac.es)
Andy Longmore (ajl@roe.ac.uk)

Extragalactic Planetary Nebula Kinematics with the WHT

Aaron J. Romanowsky¹, Nigel G. Douglas¹, Magda Arnaboldi² and Konrad Kuijken¹

¹: Kapteyn Astronomical Institute; ²: Osservatorio Astronomico di Capodimonte

In spiral galaxies, the observability to large radii of cold gas disks has facilitated a general understanding of the distribution of mass in their outer parts. Elliptical galaxies, being gas poor, are not amenable to this approach, and other tracers are necessary. The standard approach is to observe the kinematics of the stars using integrated light spectroscopy. However, an elliptical's surface brightness drops off rapidly at large radii, making such observations quite difficult in the outer parts where any dark matter would become dominant (\geq an effective radius R_{eff}).

One approach especially suitable for elliptical galaxies is to measure the kinematics of bright objects within their outer parts: globular clusters (GCs) and planetary nebulae (PNe). With a suitably large number of measured velocities, and with careful dynamical models, these objects can be used to effectively constrain the mass distribution of ellipticals.

PNe have some advantages over GCs. Primarily, they can be expected to directly represent the underlying bulk stellar population of the galaxy (GCs comprise a disjoint system with quite different properties), and thus their kinematics can be combined with the integrated stellar kinematics in the inner parts to model the galaxy over a large range of radii. Also, PN velocity measurements are more straightforward, as there is simply a strong emission line of [O III] at 5007 Å to be observed.

The traditional procedure for obtaining PN kinematics in a galaxy is to locate a sample of PNe using narrow-band imaging, and to subsequently use a multi-object spectrograph to obtain their velocities. This is described in more detail below, in connection with

our observations of the galaxy NGC 4472.

But more efficient in many cases is a new technique called counter-dispersed imaging, wherein the detection and velocity measurements of the PNe are combined into one observational step. We are members of a team which is building a specialised instrument to use this technique: the *Planetary Nebula Spectrograph*, soon to be commissioned at the WHT. This instrument is further described below.

NGC 4472 with AF2/ WYFFOS: Observational Procedures

NGC 4472 (= M49) is a giant elliptical galaxy in the Virgo Cluster which has PN position data already available. The PNe were located using a combination of broad- and narrow-band images of a 16'×16' field centred on the galaxy, taken by X. Hui at the KPNO Mayall 4-m telescope on 27 March 1995. Point sources which were visible only in the narrow-band image (with a passband at the 5007 Å line) were identified as PN candidates. With a small supplement from Jacoby, Ciardullo, & Ford (1990), there were a total of ~200 PN candidates.

We used AF2/WYFFOS on four half-nights, 25–28 May 2000, with R. Corradi as support astronomer. WYFFOS is of course the multi-fibre spectrograph and AF2 is the robotic device which positions the fibres at the WHT prime focus. We selected the high efficiency H1800V IDS grating, which gave a reciprocal dispersion of 0.9 Å per pixel. In general the instrumentation all worked very well, and we obtained about 10 hours of data on two different fields. There are strong physical restrictions on

AF2's placement of fibres on a centrally-concentrated target area, so we could use only ~25 of the 100 available science fibres at one time. The most important concern in the observational procedure was astrometric accuracy, an issue which had stymied previous attempts to use multi-slit and multi-fibre spectrographs to observe PNe at Virgo Cluster distances. First, the pixel coordinates in the original detection image of the PN candidates must be converted to RA/Dec for input to AF2. We accomplished this with IRAF, using reference stars from the USNO-A2.0 catalogue (Monet et al., 1998). But the number of suitable reference stars (~75) was insufficient to adequately map the plate distortions of the wide-field detection image, resulting in astrometric uncertainties of ~2" in the galaxy's perimeter — the most important region for kinematical purposes. We found by trial-and-error at the telescope that a low-order plate fit was the best.

Second, AF2 must also be given fiducial stars on which to guide during observations. It is crucial that these fiducial stars are a subset of the reference stars used to determine the PN coordinates. However, the small number of USNO stars in our field that were suitably bright for guiding made it difficult to place enough fiducial fibres. Additionally, the guide fibres typically did not fit well on many of the fiducial stars at once, indicating that there was significant proper motion in the USNO stars.

Despite these difficulties, we were able to get most of the object fibres positioned to within the tolerances of their 2".7-diameters. By placing a fibre in each field on one especially bright PN candidate (which turned out to be an HII region — see below), we could verify the positioning after a half-hour exposure.

NGC 4472: Results

With most of the data so far analysed, we have identified 24 PN candidates. There are some rare background objects that can masquerade as PNe — the sure way to determine if an object is a PNe is by the detection of a second [O III] line at 4959\AA , with a 1:3 flux ratio to the 5007\AA line. Since our signal-to-noise ratio is too low to measure the 4959\AA line for most of the objects individually, we sum the spectra to look at the aggregate line ratio (see Freeman et al., 2000), and determine that almost all of the candidates are bona fide PNe. These PNe are spread throughout the galaxy, with galactocentric radii of $2'-8' = 8-40\text{ kpc} = 1-5 R_{\text{eff}}$ (see Figure 1). The overall velocity dispersion of the sample is $299 \pm 46\text{ km/s}$.

One feature that is apparent is that the velocity dispersion is higher (at 95% significance) on one side of the major axis than on the other ($350 \pm 63\text{ km/s}$ vs $143 \pm 48\text{ km/s}$; see Figure 2). This is a surprising result which will require confirmation with more PN velocities. Checking to see if the same feature appears in the galaxy's system of GCs, which have had 144 velocities measured (Zepf et al., 2000), we also find a velocity difference at 90% significance ($351 \pm 30\text{ km/s}$ vs $262 \pm 25\text{ km/s}$). With these PN data, combined with integrated light spectroscopy from Fisher, Illingworth, & Franx (1995), we construct a projected velocity dispersion profile $\sigma_p(R)$ (Figure 3). Although the integrated light spectroscopy is consistent with a dispersion profile that decreases rapidly outside 10 kpc, the PN data indicate that the dispersion profile either remains constant, or even rises, through 30 kpc.

We next construct a crude dynamical model, using the Jeans equations and assuming an isotropic stellar orbit distribution. We find a mass profile $M(r) \sim r^{0.9}$ at 4–40 kpc (see Figure 4). This is a steeper growth curve than for a constant mass-to-light ratio

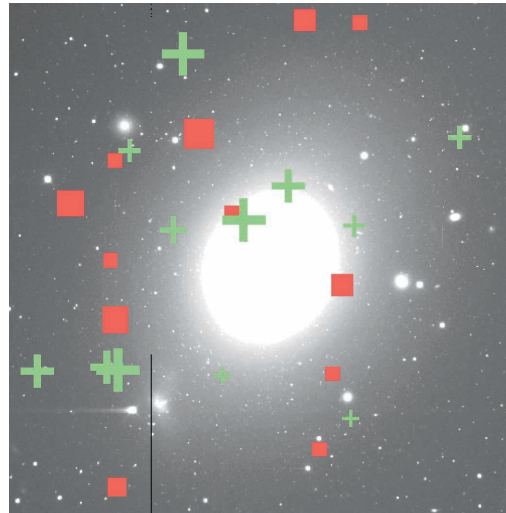

Figure 1. Planetary nebula velocities in NGC 4472, relative to a systemic velocity of 977 km/s. Green crosses represent negative velocities, and red boxes represent positive velocities, where the symbol sizes are proportional to the velocities. North is at the top and east at the left. The underlying image is from X. Hui, with a field-of-view of $16' \times 16'$.

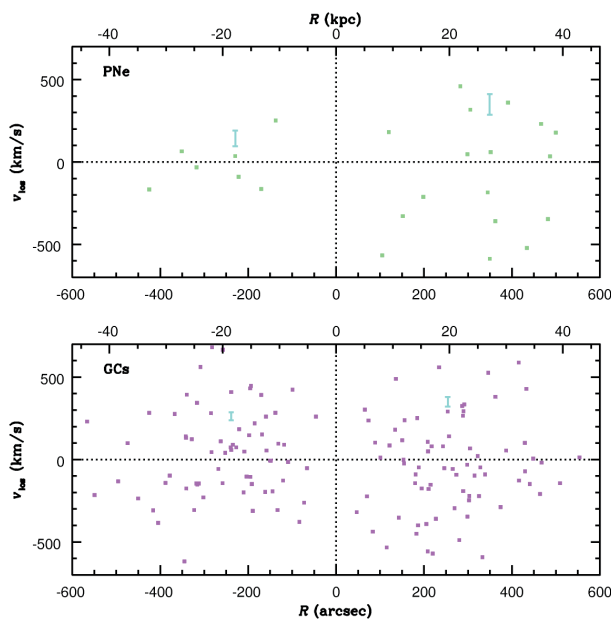

Figure 2. Line-of-sight velocities of planetary nebulae (top) and globular clusters (bottom) as a function of radius, relative to the central velocity of NGC 4472. Objects with a positive radius lie on the northeast side of the galaxy's major axis, and those with a negative radius on the southwest side. The overall velocity dispersion on either side is marked with error bars.

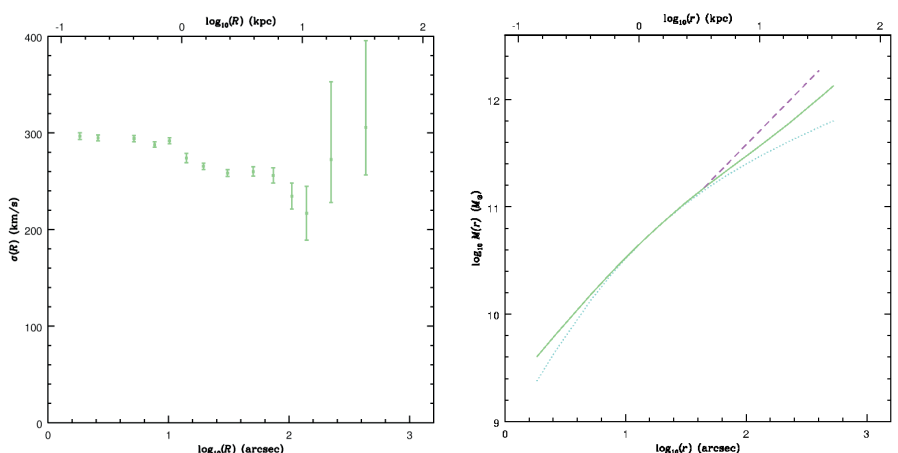

Figure 3 (left). Stellar projected velocity dispersion as a function of radius for NGC 4472, with $1-\sigma$ error bars. The first 12 points come from the integrated light spectroscopy of Fisher, Illingworth, & Franx (1995). The last 2 points represent our planetary nebulae data. Figure 4 (right). Enclosed mass as a function of radius for NGC 4472. The solid line shows the results derived from the stellar kinematics (integrated light + planetary nebulae), assuming an isotropic distribution function. The dashed line shows the results from the globular cluster kinematics, also assuming isotropy (Zepf et al., 2000). The dotted line shows a constant mass-to-light ratio model.

galaxy ($\sim r^{0.5}$), suggesting the presence of a dark halo. A similar analysis with GC data yielded $M(r) \sim r^{1.1}$ (Zepf et al., 2000). In the near future we will make a more rigorous analysis of the combined PN and GC data set using the orbit modelling methods of Romanowsky & Kochanek (2001).

We found another interesting feature serendipitously. One especially bright PN candidate turned out to be not a PN at all, but an HII region, as indicated by the $H\beta$ line at 4861\AA in addition to the $[O\text{ III}]$ lines at 4959\AA and 5007\AA . Two other objects that we observed in the same vicinity turned out to have the same redshift. Thus, these three objects are bright HII clumps in a contiguous region of gas, of at least 1 kpc in extent — surprising, since such a galaxy should have little gas and star formation. Using SIMBAD, we discovered that these HII regions are part of a structure which has been studied on several occasions. They appear to belong to a reservoir of gas which was somehow stripped out of the nearby dwarf irregular galaxy UGC 7636 during an interaction with NGC 4472. This structure has been observed in HI emission (e.g., Sancisi, Thonnard & Ekers, 1987), X-ray absorption (Irwin & Sarazin, 1996) and broad-band imaging (Lee, Kim & Geisler, 1997), and our brightest object was spectroscopically found to be an HII region (Lee, Richer & McCall, 2000). We were able to determine highly accurate velocities for the HII regions, which may help shed light on the past dynamical history of UGC 7636 and its lost gas cloud.

Planetary Nebula Spectrograph

The technique of counter-dispersed imaging was introduced by Douglas & Taylor (1999). A galaxy is simply imaged through a slitless spectrograph tuned to the 5007\AA line. When this image is studied, the background light of the galaxy and the images of foreground stars are found to be

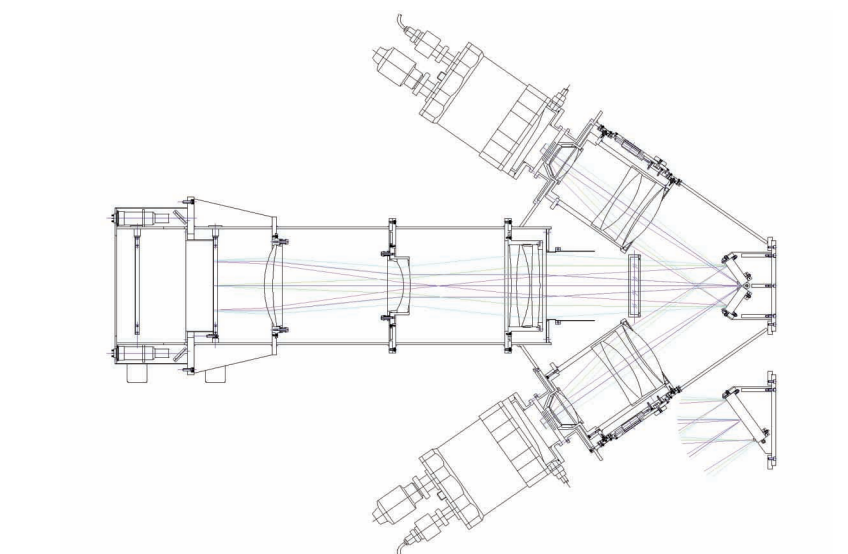

Figure 5. Sketch showing the optical arrangement of the Planetary Nebula Spectrograph. On the right-hand side, a pair of diffraction gratings can be seen to split the light beam into two identical spectrograph arms, each with a different dispersion direction.

blurred, but the PNe are instantly recognisable as bright point-like images, due to their powerful emission line at this wavelength. Each PN will be slightly displaced from its true position on the sky by an amount determined by its exact emission wavelength, and hence by its velocity.

A second image is taken in which the dispersion direction is reversed with respect to the sky. This can be done sequentially by rotating the PA through 180° , as in Douglas et al. (2000), or simultaneously using duplicate spectrograph arms (see Figure 5).

The PNe seen in the first image will be readily identified in the second, but with the direction of their displacement reversed. Therefore, these two images taken together yield *position* and *velocity*, while the *brightness* can be obtained from either image. So in one night we hope to do as well as, or better than, the traditional procedure does in two or three.

Our first observing programme will entail the observation of a large sample of nearby elliptical galaxies. Further information may be found at <http://www.aao.gov.au/local/www/pns/pns.html> and the PNS consortium is listed below (Arnaboldi et al., 1999).

We thank Don Pollacco, Renzo Sancisi and Nial Tanvir for useful conversations.

References:

- Arnaboldi, M., Capaccioli, M., Douglas, N., Kuijken, K., Freeman, K., Axelrod, T., Taylor, K., Gilmozzi, R., & Kudritzki, R., SAIT Symposium, Naples 1999.
- Douglas, N. G. & Taylor, K., 1999, *MNRAS*, **307**, 190.
- Douglas, N. G., Gerssen, J., Kuijken, K., & Merrifield, M. R., 2000, *MNRAS*, **316**, 795.
- Fisher, D., Illingworth, G., & Franx, M., 1995, *ApJ*, **438**, 539.
- Freeman, K. C., et al., 2000, in *ASP Conf. Ser. 197, Dynamics of Galaxies: from the Early Universe to the Present*, ed. F. Combes, G. A. Mamon, & V. Charmandaris, (San Francisco: ASP), 389.
- Irwin, J. A. & Sarazin, C. L., 1996, *ApJ*, **471**, 683.
- Jacoby, G. H., Ciardullo, R., & Ford, H. C., 1990, *ApJ*, **356**, 332.
- Lee, M. G., Kim, E., & Geisler, G., 1997, *AJ*, **114**, 1824.
- Lee, H., Richer, M. G., & McCall, M. L., 2000, *ApJ*, **530**, L17.
- Monet, D., et al., 1998, *The PMM USNO-A2.0 Catalog* (Washington, D.C.: U.S. Naval Observatory).
- Romanowsky, A. J., & Kochanek, C. S., 2001, *ApJ*, submitted, astro-ph/0008062.
- Sancisi, R., Thonnard, N., & Ekers, R. D., 1987, *ApJ*, **315**, L39.
- Zepf, S. E., Beasley, M. A., Bridges, T. J., Hanes, D. A., Sharples, R. M., Ashman, K. M., & Geisler, D., 2000, *AJ*, **120**, 2928. [□](#)

Aaron Romanowsky (romanow@astro.rug.nl)

New WHT Prime Focus Small Fibre Module

John Telting and Kevin Dee (ING)

At the end of semester 2001A the Small Fibre Module (SFM) will be commissioned. The SFM will be located at the prime focus of the William Herschel Telescope. At prime focus the fibres are placed at user-defined sky coordinates by the robot positioner AUTOFIB-2 (AF2). Object light collected at prime is transmitted along fibres to the Wide Field Fibre Optic Spectrograph (WYFFOS). The SFM unit will replace the existing Large Fibre Module (LFM).

The SFM is currently under construction at the ING. Fibre assembly and alignment is being done in the optics laboratory at our sea-level base and the fibre module is being manufactured in the ING mechanical workshop. The path from prime focus to the spectrograph consists of a prism, fibre button, 26 metres of fibre, finger, microlens and the facet block. The fingers and facet block have been re-designed and manufactured to accommodate the new layout of 15 fibres for each finger with a total of 10 fingers mounted onto the facet block. The fibre module unit has been modified and now incorporates extra struts. These struts reduce flexure and support the direct mounting of the new field plate. The new field plate is thicker to avoid distortion.

The SFM will feature 150 science fibres of 1.6 arcsec diameter (90 microns). The fibres are high-content OH fused silica made by Polymicro. This is the same material as those of the existing LFM. Unlike the current large fibres, they will run as one continuous stretch from AF2 to the WYFFOS spectrograph, i.e. run without fibre connectors at the top end of the telescope.

The SFM will be stored on the telescope when not in use and the mechanical engineering group is currently designing a support frame, which will mount on the side of the top end ring. It is our intention to incorporate a

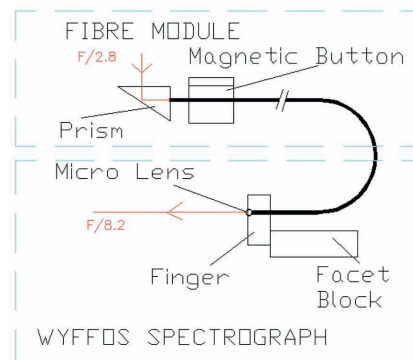
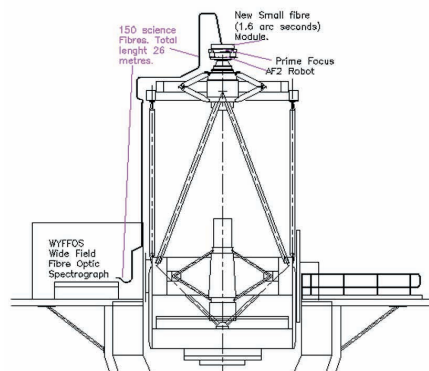

Figure 1. Left: Fibre route on WHT. Right: Science fibre schematic.

comparison lamp in the storage frame, which will allow quality checks to be made even when small fibres are not on the sky.

Astrometry, acquisition and guiding are more critical with smaller fibres. Therefore the SFM guide fibres are to be enhanced. The existing semi-coherent fibres containing 7 individual fibres are to be replaced with fully coherent imaging fibre bundles.

Selection and testing of a suitable coherent fibre is in progress. Two sample fibres are currently being tested for flexibility, resolution and throughput. A balance between the number of fibres in an imaging bundle and the core diameter of each individual fibre is required in order to get sufficient resolution and maintain required throughput. These bundles will feed an intelligent TV system that, in time, will provide autoguiding; the current large fibres system still relies on hand guiding. The coherent images of several fiducial stars will allow accurate acquisition and guiding of the science field.

Increasing the number of science fibres from 110 to 150 will increase the number of field permutations. The maximum packing density is still the same as this is constrained by the fibre buttons and gripper jaw size. However, the packing density, known

as the buffer factor in the configuration software, will be optimised now that the gripper unit is reliable. A reduction in the overall set up time of astronomical fields is to be achieved by increasing Z speed on the AF2 robot gripper and by reducing the placement iterations of each individual fibre. At this stage we cannot quantify the gains we will achieve yet.

The 150 science fibres of the SFM will have better performance than the fibres of the LFM: no light loss due to fibre connectors, and less sky contribution in the fibres. It is difficult to estimate the throughput gain due to the lack of fibre connectors. From our experience with large fibres we know that the connectors give rise to attenuation of the throughput of some but not all fibers. The new system will provide a more homogeneous distribution of fibre throughput, and on average may be 50–100% more efficient than the old system.

The ratio in sky area sampled by fibres in the small and large modules is 0.35. This means that noise levels in sky-limited observations will be down by a factor of 0.6, without accounting for other sources of throughput gain.

The small fibres will be imaged onto less than 2 pixels (FWHM) on the Tek 6 detector in the spatial direction. The full spatial image of the fibres will be sampled by less than 3 pixels.

There may be a slight gain in S/N of the extracted spectrum with respect to the large fibre case, as less pixels will have to be extracted when sampling the wings of the spatial profile. For small fibres, the fibre distance in the WYFFOS entrance slit will be 1 mm, which transforms onto a peak-to-peak aperture distance of 6.7 pixels on the detector.

The nominal spectral resolution will increase as the ratio of large to small fibre diameters, although this number

is limited as the detector will also undersample in the spectral direction. We expect the highest resolution to be around $R \sim 7500$ in echelle mode.

The 1.6 arcsec fibers were chosen as a compromise between minimum sky contribution and maximal source contribution. As the positioning, pointing and (automated) guiding errors may add to 0.5 arcsec, there will be no room anymore for astrometrical errors. Field setups that suffer from inaccurate astrometry

or an insufficient number of fiducial stars may suffer light losses of more than 50% at the fibre entrance. We caution future observers about this effect, as bad astrometry may cancel all the gains that the new SFM will offer.

Information about AF2/WYFFOS can be found at: <http://www.ing.iac.es/~jht/af2wyffos.html>. □

J. Teltig (jht@ing.iac.es), *Project Scientist*
K. Dee (kmd@ing.iac.es), *Project Manager*

RoboDIMM

Thomas Augusteijn (ING)

All observations with ground-based astronomical telescopes are affected by image distortion which results when starlight passes through turbulence in the atmosphere above the observatory. The wavefront of the incoming light suffers random aberrations as it passes through regions where there is turbulent mixing of air of different temperatures and hence refractive indices. At the focus of a telescope the effect of these aberrations is to form a rapidly changing ‘speckle’ image. For long exposures the point-spread-function (PSF) is the co-addition of a large number of random speckle images. This results in an approximately Gaussian PSF with FWHM typically in the range 0.5 to 2 arcseconds at good observing sites (Wilson et al., 1999).

This so called ‘seeing’ is a fundamental limitation of the signal-to-noise and resolution of astronomical observations.

The standard model for astronomical seeing has been reviewed in detail by Roddier (1981). From this analysis it can be shown that the seeing limited FWHM of the PSF for a long exposure with a telescope with diameter much larger than r_0 is given by:

$$FWHM = 0.98 \lambda / r_0,$$

where λ is the wavelength of observation, and r_0 is the scaling length (also known as Fried’s parameter) which is a measure of the strength of the seeing distortions (Fried, 1965). This r_0 can be thought of as the telescope diameter that would produce a diffraction spot of the same size as that produced by the atmospheric turbulence on a point source observed with an infinite mirror. The typical size of r_0 at a good observing site is 10 cm at 500 nm, which yields an image width in a long exposure of approximately 1 arcsecond.

In reality, there are many other factors which contribute to the final PSF. These include variations in the tracking and errors in the focus of the telescope, and the quality of the optics and their alignment. Also aberrations caused by turbulence inside the dome (‘dome seeing’) can be important.



Figure 1. Mockup of RoboDIMM.

Monitoring the Seeing

Why is it of interest to have a seeing monitor? In the first place it will provide a baseline seeing measurement for quality control of all instruments and telescopes. This will give a real-time assessment of image quality (such as focus optimization, etc.), as well as data for long-term remedial work (such as improving the seeing at the INT). A good example of the latter has been the study of the seeing quality at the WHT (Wilson et al., 1999).

A seeing monitor will also provide an on-line measure of extinction and allow optimization of queue/service observing (e.g., for observing with NAOMI; see O’Mahony, 2001) — we would always have an accurate measure of the current/recent seeing and its stability. For these very same reasons many of the major

observatories around the world are operating, or planning to operate, seeing monitors continuously.

Differential Image Motion Monitor

To measure the seeing one can look at the variance of the position of a star which is given by:

$$\sigma^2 = 0.373 \times FWHM^2 \left(\frac{r_0}{D}\right)^{1/3},$$

where D is the diameter of the telescope. Thus, measuring the motion of a star at a given wavelength λ define r_0 , and hence the seeing can be deduced. This method has been used in the past, but it requires a very stiff (and therefore massive) telescope because the image motion will include variations due to tracking errors or wind shake.

To avoid these problems the differential image motion monitor (DIMM) was developed (Sarazin & Roddier, 1990, and references therein). The principle of the DIMM is to measure the variance of the differential motion of images of a star produced with the same telescope via two entrance pupils separated by a distance S . Using the differential image motion eliminates the effects of tracking errors and wind shake, and is little affected by small focus errors, giving an unbiased estimate of the image degradation due to the atmosphere alone. Two independent measurements are provided by the motion in the longitudinal and transverse direction (parallel and perpendicular to the aperture alignment), as given by the variance:

$$\sigma_{l/t}^2 = \sigma^2 \left[1 - k_{l/t} \left(\frac{d}{S}\right)^{1/3} \right]$$

with

$$k_l = 0.541 \text{ and } k_t = 0.810,$$

where d is the size of the entrance pupils (Vernin & Muñoz-Tuñón, 1995). An added advantage of this method is that the two measurements also allows a direct check of the data.

RoboDIMM

In the past a DIMM has been operated at the ING as part of the afore mentioned study to investigate the image quality of the WHT. This DIMM was located on an open tower 100 m from the WHT building, so that dome seeing and low level ground-to-air seeing effects are avoided. However, the use of the DIMM required the permanent attendance of an operator, which is very expensive if you want to operate it continuously.

Recently a project was proposed to develop and install a 'RoboDIMM'. This project was approved in November 2000. The aim of the project is to provide automatic seeing measurements throughout each observing night. This includes automatic selection of targets, pointing of the telescope and tracking of the targets, and acquisition and processing of the data. Opening and closing of the dome will be done remotely from the WHT control room. Also, the general operation of the system will be monitored from the WHT control room.

The RoboDIMM will consist of a clamshell dome with a 12" Meade telescope installed on the existing tower (a mockup is shown in Figure 1). The detector will be a CCD which can provide 10 ms exposures, which is required to effectively freeze the wavefront variations. It will be controlled from a PC in the WHT control room, which will communicate via a fibre network connection to the DIMM tower.

The project is now well underway, and we have ordered the dome and the parts for the power supply and the fibre optics cable, and contracted a local company to modify the tower. In the near future we will order the telescope and the CCD, and we hope to finalise our negotiations with a software company to develop the control software. The current planning is to have the RoboDIMM assembled during the summer, and complete the integration and commissioning in the autumn of this year.

In the future the RoboDIMM could be upgraded easily to provide a more comprehensive seeing monitor for optimisation of Adaptive Optics (AO) at the WHT, based on the SCIDAR (scintillation detection and ranging) technique. The system would give real-time measures of the vertical profile of turbulence and turbulence velocity from the analysis of scintillation patterns of binary stars (Caccia & Vernin, 1990). For AO this data is required to optimise the PSF at off-axis field points, and to determine the (very large) anisoplanatic variations of the corrected PSF with field angle (for deconvolution and post processing).

The RoboDIMM project manager is Michael Simpson and the author is the project scientist. Also involved in this project are Karl Kolle and Neil O'Mahony, all of whom are working at the ING.

References:

- Caccia, J. -L., Vernin, J., 1990, *J Geophys Res*, **95**, 13683.
 Fried, D. L., 1965, *J Opt Soc Am*, **55**, 1427.
 O'Mahony, N., 2001, "Astronomical Site Evaluation in the Visible and Radio Range", eds. J. Vernin, C. Muñoz-Tuñón, and Z. Benkhaldoun, *ASP Conference Series*, in press.
 Roddier, F., 1981, "Progress in Optics 19", ed. E. Wolf, North-Holland, Amsterdam.
 Sarazin, M., Roddier, F., 1990, *A&A*, **227**, 294.
 Vernin, J., Muñoz-Tuñón, C., 1995, *PASP*, **107**, 265.
 Wilson, R. W., O'Mahony, N., Packham, C., Azzaro, M., 1999, *MNRAS*, **309**, 379.
 □

Thomas Augusteijn (tau@ing.iac.es)

OTHER NEWS FROM ING

Scientific Conference Organised by ING

Johan H. Knapen (ING)

ING is organising a major international conference, entitled "The central kiloparsec of starbursts and AGNs: the La Palma connection", which will be held from 7 to 11 May 2001, on La Palma. The conference is organised completely within ING, and financially supported by ING, the Excmo. Cabildo Insular de La Palma (local government) and the Patronato de Turismo de La Palma (tourist board). It will be held in the luxurious Hotel Hacienda San Jorge, in the small resort town of Los Cancajos, which is very close to ING's sea-level base in Santa Cruz de La Palma.

The conference has been motivated by recent advances in high-resolution observations, theory and modelling, which have focused our attention on the central kiloparsec regions of nearby disk galaxies. These regions often show profound starburst and/or nonstellar activity, accompanied by intricate gas and dust morphologies and kinematics. One of the main themes of the conference is the study of the origin and evolution of the phenomena occurring in these central regions, and their possible causal interrelationships. The delegates will also explore links between the central kiloparsec regions and their host galaxies, and the roles these regions play in galaxy evolution. The conference will review recent progress and discuss the future strategies on this research field.

Invited reviews will be given by a number of eminent astronomers from USA and Europe, including D. J. Axon (Univ. of Hertfordshire, U.K.), J. E. Beckman (IAC, Spain), F. Combes (Obs. de Paris, France), B. G. Elmegreen (IBM, USA), J. H. Knapen (Univ. of Hertfordshire, U.K. and ING), C. Leitherer (STScI, USA), D. Lynden-Bell (Univ. of Cambridge, U.K.), C. Norman (Johns Hopkins Univ. and STScI, USA), D. Merritt (Rutgers Univ., USA), N. Z. Scoville (CalTech, USA), I. Shlosman (Univ. of Kentucky, USA), and K. A. Weaver (Johns Hopkins Univ., USA). The attendance to the conference is limited by the capacity of the conference room in the hotel to just over 100 people.

For further information, we have set up a website with address:

<http://www.ing.iac.es/conferences/centralkpc/>.

□

Johan H. Knapen (centralkpc@ing.iac.es, knapen@ing.iac.es),
Chair of the Local Organising Committee.

News from the Roque

A picture is worth a thousand words... So rather than wasting many lines we show two recent pictures of buildings that are being erected. The first one is of the 1.2-m Mercator telescope facility, located close to the Isaac Newton telescope and not to be mistaken with the future Liverpool telescope that will be constructed nearby. The second picture shows progress made on the GranTeCan 10-m telescope project. The lower part of the telescope building is well advanced. The gaps in the concrete construction are for future air ventilation apertures of the dome area. Recently the University of Florida and two Mexican institutes, UNAM and INAOE, signed up to the GranTeCan project.



THE CENTRAL KPC of STARBURSTS and AGNs:

THE LA PALMA CONNECTION

7-11 May 2001

Invited Speakers:
D.J. Axon
J.E. Beckman
F. Combes
B.G. Elmegreen
J.H. Knapen
C. Leitherer
D. Lynden-Bell
D. Merritt
C.A. Norman
N.Z. Scoville
I. Shlosman

The ING High-Quality CCD Image Collection

Our recent experience shows that there exists a big demand for high-quality astronomical images. In particular the press and the general public show a strong interest in images highlighting the scientific results from our telescopes and the beauty of the night sky above La Palma.

ING is in the favourable position in that it possesses world-class CCD imaging instruments capable of providing deep-sky and wide-field views of galaxies, star clusters, nebulae, comets, etc. Furthermore ING's on-line scientific data archive facilitates the easy selection and production of interesting images.

With the help of ING staff and in close collaboration with the experienced amateur astronomer Nik Szymanek we are building up a collection of high-quality true-colour CCD images for public use. All images will become available on-line through ING's Public Information web pages.

The two images on this page are a good example of what has already been generated. M15 globular cluster is shown on the right and M95 galaxy is shown below. Both images were taken using a CCD camera on the JKT. □

Javier Méndez (jma@ing.iac.es), *ING Public Relations Officer*



News from the Computing Facilities Group

Don Carlos Abrams (Head of Computing, ING)

In October of 2000, Pioneer launched the internal DVD-R drives for the DRM7000, the jukebox used by many research and commercial establishments including the ING. The new drives are compliant with the long awaited Book 2 Media and provide a key element for our proposed DVD library.

After many long months of hardware and software related issues the first Book 2 DVD was written automatically using the software developed in-house by the CFG. The system had been running for several days and was configured to archive data from the INT, unfortunately IDS was in use and thus did not produce sufficient data to allow us to write a complete DVD.

However, on the night of the 18th of January the Wide Field Camera came into play for the first time since the new archive had been running. It wasn't long before sufficient data had been acquired and the DVD library sprang into action having collated more than 4.7 Gb of data. We have been waiting for this day for many months and it was certainly worth waiting for. So, we are now in a position to be able to write observational data to DVDs for the INT.

What's next? Well, these are still very early days, we need to incorporate data from the WHT and the JKT and just as importantly we need to work very closely with the Astronomy Group to ensure that reduced data, produced by the Beowulf System (<http://www.ing.iac.es/~astrosw/InstSoft/wfcred/quicklook.html>), are archived in a similar fashion.

The DRM 7000 towers connected to a Sun Microsystems Ultra 10 with two Hewlett Packard 6-slot external DAT loaders will form the core of the ING's data management system. The development of a new archiving strategy, involving DVD technology, has provided the CFG with an opportunity to re-examine the life cycle of our observational data. This has led to a number of improvements in the way images are handled. One such improvement has been the successful installation of an automated D-tape creation system, relieving the astronomer of the burden of having to create D-tapes. The D-tape creation process is now tightly bounded with the DVD archive, providing better data security and an easier image tracking system which will be made available for general use.

On another topic, the hardware required for the installation of our first Beowulf System was recently delivered, installed and configured. The equipment is now located in the INT Clip Centre and is currently being tested and prepared by the Astronomy Group. Initial results are very encouraging and a recent visit by Jim Lewis, from the CASU (<http://www.ast.cam.ac.uk/~mike/casu/>), proved to be fruitful and enlightening in our quest for the provision of reduced data. ▣

Don Carlos Abrams (don@ing.iac.es)



The new DVD-R jukeboxes in the WHT computer room.

Bug in AF2/WYFFOS Reduction Software

John Telting and Robert Greimel (ING)

WYFRED is the IRAF package that can be used to reduce data obtained with AF2/WYFFOS. It was written especially for AF2/WYFFOS data reduction, and was distributed under the IRAF RGO package that is in use at the ING. The software makes use of a correspondence table that matches fibre numbers to aperture numbers on the detector. This correspondence table can be found in the file `rgo/wyffos/lib/crossLARGE` in the external IRAF tree.

In the summer of 2000 one of the fibres (#90) in the Large Fibre Module was disabled because it suffered some mechanical problems. This led us to discover that the aperture numbers corresponding to fibres #89 and #90 were swapped in the WYFRED correspondence table. This means that data reduced with WYFRED may suffer from confusion of the objects observed with these fibres. The correct correspondence table is listed in version 1.03 of the AF2/WYFFOS manual available from http://www.ing.iac.es/Astronomy/observing/manuals/man_wht.html. Older versions of the manual contain the wrong table.

As of October 2000 we have updated our IRAF WYFRED distribution at ING. We maintain a downloadable distribution of WYFRED at <http://www.ing.iac.es/~astrosw/InstSoft/rgo/>. ▣

John Telting (jht@ing.iac.es), *AF2 Instrument Specialist*, Robert Greimel (greimel@ing.iac.es), *Astronomy Software Support*.

Other ING Publications and Information Services

[INGNEWS] is an important source of breaking news concerning current developments at the ING, especially with regard to instruments.

You can subscribe to this mailing list by sending an email to majordomo@ing.iac.es with the message *subscribe ingnews* in the body. Please leave the subject field and the rest of the body of the message empty.

Once subscribed, you can subscribe a colleague by sending to majordomo@ing.iac.es the command *subscribe ingnews your_colleague's_address*. To unsubscribe from [INGNEWS] send to majordomo@ing.iac.es the command *unsubscribe ingnews*. More information on [INGNEWS] can be found on this web page: <http://www.ing.iac.es/Astronomy/science/bulletin/>

These are the subjects of the last messages sent to the list:

9 September

- "ING Instrumentation in Semester 2001A"
- "Availability of ING Newsletter No. 3"
- "Astronomy jobs at the ING"
- "Conference; The Central Kpc of Starbursts and AGNs: The La Palma Connection"

22 September

- "NAOMI First Light and Performance"

Other ING publications are available on-line at the URLs below:

Annual reports: <http://www.ing.iac.es/PR/AR/>

Press releases: <http://www.ing.iac.es/PR/press/>

Manuals and technical notes:

<http://www.ing.iac.es/Astronomy/observing/manuals/>

In-house research papers:

<http://www.ing.iac.es/Astronomy/science/ingpub/>

Seminars Given at ING

Visiting observers are politely invited to give a seminar at ING. Talks usually take place in the sea level office in the afternoon and last for about 30 minutes plus time for questions afterwards. Astronomers from ING and other institutions on site are invited to assist. Please contact Johan Knapen (knapen@ing.iac.es) and visit this web page <http://www.ing.iac.es/Astronomy/science/seminars.html> for more details. These were the seminars given in the last six months:

31 August. *Models and observational predictions for the thermal structure of MHD jets*, P. Garcia (ING)

19 September. *NAOMI commissioning*, A. Longmore (ATC, Edinburgh)

18 October. *Searching for satellite galaxies at medium redshifts*, F. Prada (Calar Alto Observatory)

27 October. *The first galaxies — clues from element abundances?*, M. Pettini (IoA Cambridge)

9 November. *Gigawulf: Powering the Isaac Newton Group's Data Pipeline*, R. Greimel (ING)

10 November. *Application of Wavefront Sensors to the Optimisation of a 4m Telescope*, N. O'Mahony (ING)

15 November. *Recent Gamma Ray Burst results*, N. Tanvir (Univ. of Hertfordshire)

19 December. *Substellar objects in Orion*, P. Lucas (Univ. of Hertfordshire)

10 January. *The second decade of instrumentation on HST (2001-2010) and the NGST project*, S. Smartt (Cambridge University)

15 January. *ULTRACAM — high-speed astrophysics*, V. Dhillon (Univ. of Sheffield)

17 January. *Instrumentation for SALT*, D. Buckley (SALT)

22 January. *Bars and Seyferts*, J. Knapen (ING and Univ. of Hertfordshire)

29 January. *Interactions triggering activity in Seyfert Galaxies?*, B. García (ING)

30 January. *Progress on GranTeCan*, J. M. Rodríguez Espinosa (IAC/GTC)

2 February. *Near-infrared spectroscopy of nearby Seyfert galaxies: first results*, J. Kotilainen (Turku)

19 February. *Starburst triggering and the neutral ISM in ring galaxies*, J. Higdon (Groningen)

Personnel Movements

In the administration group **Chelo Barreto** and **Montse Lorenzo** left ING after many years of service. Chelo is now working at the Joint Astronomy Centre in Hawaii, while Montse exchanged La Palma for the capital of Spain as her work and living environment.

In the same group, **Lucy Lawler** and **Teresa Dorwart** arrived to take up posts as personnel officer and in the finance section, respectively.

Pepe Riverol retired from ING's employment following several years of service in the site services group. We wish him well for the future.

Guy Woodhouse moved further North, this time to the UK, to continue his career in detector technology at the Rutherford Appleton Laboratory.

Sebastián Sánchez and **Robin Clark** have both left our sub-tropical island and are both pursuing their careers in the commercial IT sector in Madrid.

Almudena Zurita took up a post as support astronomer. Until recently Almudena was working at the IAC, where she did a PhD specialising in the field of star formation in galaxies.

We also welcome **Steven Goodsell** and **Charlie Brodie** who will both strengthen the software group.

TELESCOPE TIME

Applying for Time

Danny Lennon (Head of Astronomy, ING)

It is important that applicants for telescope time familiarise themselves with the latest news on instrumentation and detector combinations on offer, as well as with our scheduling restrictions. PPARC issue the PATT newsletter electronically, about one month before application deadlines, which contains up-to-date information on instrument availability. However for the very latest news and proposal submission procedures always refer to the ING web pages, homepage <http://www.ing.iac.es>. The ING's scheduling constraints were summarised in the first issue of the ING Newsletter and will not be repeated here, please refer to that issue, which is also available on our public information web pages.

What's New

The latter half of 2000 saw the first commissioning run of NAOMI, the ING's natural guide star adaptive optics facility. Unfortunately, this run, plus the first two NAOMI science runs towards the end of semester 2000B, were badly affected by the weather. Further commissioning of NAOMI will therefore take place during semester 2001A. It is anticipated that the ING will release a call for NAOMI service proposals for observations to be carried out in mid-June. For an update on NAOMI capabilities please refer to the article by Chris Benn in this issue.

As reported in the last newsletter, INGRID saw a very busy inaugural semester. This trend seems set to continue, and INGRID is currently undergoing a thorough overhaul in preparation for commissioning new fore-optics in early March. It is expected that this modification will result in improved image quality and better throughput for INGRID. New INGRID sensitivities will be available shortly after the fore-optics commissioning run in March. Also on INGRID, following feedback from observers and quality control checks by ING staff, a software error was discovered which manifested itself as an incorrect observation time recorded in the FITS header. The PIs of all scheduled and

service INGRID programs were notified of the existence of this problem and how to check for and correct the error.

Progress on the the long-awaited new Small Fibre Module for AF2 is excellent and it will be commissioned in July 2001 (see the article by John Telting et al. elsewhere in this issue). As part of the commissioning process we will solicit service programs from the community aimed at exploiting and testing the capabilities of the new smaller fibres. The announcement of opportunity will be distributed later in semester 2001A. Prospective AF2 applicants wishing to make use of AF2 in semester 2001B are reminded that the current Large Fibre Module is not offered for that semester as it will be replaced by the Small Fibre Module. Information on the expected throughput of the new system can be found on the AF2 instrument homepage.

Due to pressure on the GHRIL platform and the need to carry out Rayleigh laser beacon tests early in 2001B, it is likely that INTEGRAL will only be available on the WHT in the second half of that semester. This of course will have important repercussions on the scheduling of INTEGRAL proposals and interested parties should therefore endeavour to select targets for the second half of the semester only. Our more long term plans for INTEGRAL are to continue to offer it into the beginning of semester 2002A but thereafter to decommission it or offer it up for adoption as a private instrument.

The new ING data acquisition system, UltraDAS, continues to be rolled out onto other detectors. The most notable additions to the UltraDAS suite are the ISIS blue and red detectors, which were switched over in January of this year. Despite some teething problems the general impression from observers concerning performance has been very positive, and readout times are much reduced. Please refer to the ING detector information pages at our web site for details. By the end of 2001 we expect all detectors at the ING to be using UltraDAS.

Finally, important progress is being made in porting pipeline data reduction and quick-look software to ING computers. An important milestone in this process was the successful installation of the WFC pipeline software on our new Beowulf cluster at the INT (see the article by Robert Greimel et al. elsewhere in this issue). At the time of writing, tests are also being carried out on WHT Prime Focus data and INGRID data. Our objective is to be able to offer observers the option of requesting pipeline reduced science data as a product of their observing run at the ING.

WHT Development Plans

Summer 2002 will see the start of a major reorganisation of WHT instrumentation necessitated by the move to routine use of Adaptive Optics (AO) instrumentation. Detailed plans are tentative, and still have to be discussed at ING Board level, however we intend to construct a new GRound based Adaptive optics Controlled Environment (GRACE) on the Nasmyth platform currently occupied by UES. GRACE will house all ING AO instruments including NAOMI and OASIS. The current GHRIL side will continue to host WYFFOS and provide a focal station for visiting instruments.

Also, UES will be removed from its current location in the summer of 2002. If sufficient community interest is forthcoming it is envisaged that UES could in future be offered in a fibre-fed mode. Potential applicants for UES are advised therefore that semesters 2001B and 2002A will be the last for which UES will be available at the Nasmyth focus. □

Danny Lennon (djl@ing.iac.es)

Important Dates

Deadlines for submitting applications

UK PATT and NL NFRA PC:
31 March, 30 September

SP CAT: **1 April, 1 October**

ITP: **30 June**

Semesters

Semester A:

1 February – 31 July

Semester B:

1 August – 31 January

Telescope Time Awards Semester 2001A

For observing schedules please visit this web page:
<http://lpss33.ing.iac.es:8080/cgi-bin/schedules.pl>

ITP Programmes on the ING Telescopes

- Barcons (IFCA), *An XMM-Newton international survey (AXIS-II): unveiling the hard X-ray source populations.* [ITP/2001/2](#)
- Doressoundiram (OP), *Multi-color taxonomy of trans-Neptunian objects.* [ITP/2001/1](#)
- Molés (CSIC), *A photometric wide-field survey of low-z clusters.* [ITP/2001/3](#)

William Herschel Telescope

UK PATT

- Balogh (Durham), *K-Band Luminosities of CNOC2 Group Galaxies.* [W/2001A/22](#)
- Benn (ING), *Dust-free star-formation rate at $z < 0.5$ from sub-mJy radio sources.* [W/2001A/31](#)
- Charles (Southampton), *An Optical/UV/X-ray Study of a Luminous LMXB in a Globular Cluster.* [W/2001A/33](#)
- Davies (Durham), *Galaxy Evolution in Rich Clusters: Preparing for GMOS.* [W/2001A/45](#)
- Davies (Durham), *Mapping Early Type Galaxies along the Hubble Sequence.* [W/2001A/59](#)
- Ferguson (IoA), *A Search for Recent Massive Star Formation in Gas-Rich Ellipticals/SOs.* [W/2001A/63](#)
- Hynes (Southampton), *Weighing the Black Hole in XTE J1118+480.* [W/2001A/48](#)
- Ivison (UCL), *Star-Forming Galaxies in High Density Environments in the Early Universe.* [W/2000B/37](#). Long-term.
- Ivison (UCL), *A Multi-colour Search for Galaxies in High Density Environments in the Early Universe.* [W/2000B/45](#). Long-term.
- James (LJMU), *Extinction corrections for an H α galaxy survey using the Br γ line.* [W/2001A/11](#)
- Keenan (QUB), *Early type stars in the Galactic halo from the Palomar-Green Survey.* [W/2001A/14](#)
- Knapen (Herts), *Studying Star Formation Triggering via Age-Dating of Circumnuclear Hotspots.* [W/2001A/19](#)
- Kodama (Durham), *The K-band Luminosity Function of the Highest Redshift Clusters.* [W/2001A/34](#)
- Kuntschner (Durham), *An INGRID/HST Study of Early-type Galaxies in the Outskirts of Distant Clusters.* [W/2001A/9](#)
- Marsh (Southampton), *Cataclysmic Variable Stars from the 2dF QSO Survey.* [W/2001A/35](#)
- Merrifield (Nottingham), *Planetary nebula kinematics of round elliptical galaxies.* [W/2001A/51](#)
- McMahon (IoA), *The contribution to the metagalactic ionising UV background from $z=3$ and $z=5$ quasars.* [W/2001A/76](#)
- Outram (Durham), *Do QSOs trace the same structures as their absorption systems?* [W/2001A/69](#)
- Pettini (IoA), *Star-forming Galaxies and Ly α forest at $1.5 < z < 2.5$: the Galaxy-IGM Connection.* [W/2001A/15](#)
- Pollacco (QUB), *Restarting the fast wind in the Sakurai Object (V4334 Sagittarii).* [W/2001A/12](#)
- Rawlings (Oxford), *The cosmic evolution of radio sources using the TEXOX 1000-source redshift survey.* [W/2001A/80](#)
- Refregier (IoA), *Measuring Cosmological Parameters with Weak Gravitational Lensing.* [W/2001A/62](#). Long-term.
- Ryan (OU), *Angular momentum transfer in ultra-Li-depleted halo dwarf stars and blue stragglers.* [W/2001A/1](#)
- Smail (Durham), *Disentangling the ERO Population: A Survey with INGRID of Archival WFPC2 Fields.* [W/2001A/6](#)
- Steeghs (Southampton), *The structure of AM CVn binaries and their discs.* [W/2001A/46](#)

- Tadhunter (Sheffield), *The early evolution of powerful radio sources.* [W/2001A/53](#)
- Tanvir (Herts), *Rapid imaging of GRB error boxes and spectroscopy of GRB-related optical/IR transits.* [W/2001A/67](#). Override.
- Ward (Leicester), *The Nature and Environment of Galactic Super Eddington Sources.* [W/2001A/49](#)
- Warren (ICST), *Remote halo blue horizontal branch stars and the mass of Milky Way.* [W/2000B/36](#). Long-term.

NL NFRA PC

- Higdon (Kapteyn), *Tidal dwarf galaxies in Arp 143's Plume.* [w01an010](#)
- Kuijken (Kapteyn), *Planetary nebula kinematics of round elliptical galaxies.* [w01an011](#)
- Lacerda (Leiden), *Rotational Properties of (smaller) Kuiper Belt Objects.* [w01an001](#)
- Orosz (Utrecht), *The mass of the black hole in the X-ray nova XTE J1118+480.* [w01an004](#)
- Spruit (Amsterdam), *Circumbinary material in Cataclysmic Variables.* [w01an005](#)
- Vreeswijk (Amsterdam), *Rapid imaging of GRB error boxes and spectroscopy of GRB-related optical transients.* [w01an008](#). Override.
- de Zeeuw (Leiden), *Mapping Early-Type Galaxies along the Hubble Sequence.* [w01an002](#)

SP CAT

- Arribas (STScI), *2D spectroscopy of the inner regions of AGNs and QSOs.* [W15/2001A](#)
- Balcells (IAC), *Study of galaxies under extreme star formation at high redshifts.* [W14/2001A](#)
- Battaner (Granada), *Stellar system rotation in the peripheries of spiral galaxies.* [W5/2001A](#)
- Castro-Tirado (IAA/LAEFF), *Rapid detection of the optical counterparts of GRBs.* [W28/2001A](#). Override.
- Colina (IFCA), *Integral field spectroscopy of ultraluminous galaxies.* [W4/2001A](#)
- Erwin (IAC), *Inner Bars, Disks, and Nuclear Rings Along the Hubble Sequence.* [W29/2001A](#)
- García-Lario (ESA), *High resolution spectroscopy of peculiar cool stars of young planetary and proto-planetary nebulae.* [W11/2001A](#)
- Gorgas (UCM), *The initial mass function of stellar formation in elliptical galaxies and bright spheriodals.* [W10/2001A](#)
- Israelian (IAC), *Have the extra-solar parent stars engulfed planets?* [W17/2001A](#)
- Lipari (OAC), *2D spectroscopy of a sequence of IR mergers.* [W6/2001A](#)
- Martínez-Delgado (IAC), *Destruction of dwarf galaxies in the galactic halo: Sagitario North current kinematics.* [W13/2001A](#)
- Mora (UAM), *Characterization of protoplanetary disks.* [W16/2001A](#)
- Muñoz (IAC), *Limits on the cosmological parameters (Ω_p , λ_p) from statistics of gravitational lenses.* [W21/2001A](#)
- Ruiz-Lapuente (Barcelona), *Stellar companions of supernovae.* [W25/2001A](#)
- Ruiz-Lapuente (Barcelona), *Supernovae at $z=0.36-0.65$: a study of the nature of dark energy.* [W26/2001A](#)

INSTRUMENT BUILDERS' GUARANTEED TIME

- Packham (Florida), *The initial conditions to star formation.* [GT/2001A/1](#)

Isaac Newton Telescope

UK PATT

- Benn (ING), *Search for $z \sim 4$ radio QSOs.* [I/2001A/5](#)
- Benn (ING), *Extinction of background radio galaxies by foreground spirals.* [I/2001A/15](#)
- Feltzing (Lund), *Metallicity distribution functions in Local Group dwarf spheroidal galaxies.* [I/2001A/13](#)
- Maxted (Southampton), *Subdwarf-B stars are the result of common-envelope evolution.* [I/2001A/3](#)
- McHardy (Southampton), *Deep U,B,I-band Imaging of a Very Deep XMM/Chandra Survey Field.* [I/2001A/2](#)
- McMahon (IoA), *A Public Near IR imaging survey on the INT.* [I/2001A/23](#)
- Morales-Rueda (Southampton), *Spectroscopy of dwarf novae in outburst.* [I/2000B/5](#). Long-term.
- Rawlings (Helsinki), *Diffuse Interstellar Bands toward the early-type Stephenson stars.* [I/2001A/4](#)
- Ray (DIAS), *The Dynamics of Large Scale Outflows from Young Stars.* [I/2001A/9](#)
- Steeghs (Southampton), *A search for AM CVn binaries among DB white dwarfs.* [I/2001A/16](#)
- Tanvir (Herts), *Rapid imaging of GRB error boxes and spectroscopy of GRB-related optical/IR transients.* [I/2001A/18](#). Override.
- Warren (ICST), *Accurate measurement of the mass of the Milky Way dark halo.* [I/2001A/20](#)

NL NFRA PC

- Jimenez (Kapteyn), *A much-improved stellar library for stellar population synthesis.* [i01an002](#)
- Lacerda (Leiden), *Rotational Properties of (larger) Kuiper Belt objects.* [i01an001](#)
- Noordermeer (Kapteyn), *Optical spectroscopy of galaxies in the WHISP sample.* [i01an003](#)
- Vreeswijk (Amsterdam), *Rapid imaging of GRB error boxes and spectroscopy of GRB-related optical/IR transients.* [w01an008](#). Override.

UK/NL WFS Programmes

- Dalton (Oxford), *The Oxford Deep WFC Survey.* [WFS/2001A/6](#)
- Davies (Cardiff), *Multi-Coloured Large Area Survey of the Virgo Cluster.* [WFS/2001A/2](#)
- van den Heuvel (Amsterdam), *The Faint Sky Variability Survey II.* [WFS/2001A/1](#)
- McMahon (IoA), *The INT Wide Angle Survey.* [WFS/2001A/8](#)
- Walton (ING), *The Local Group Census.* [WFS/2001A/4](#)
- Watson (Leicester), *An Imaging Programme for the XMM-Newton Serendipitous X-ray Sky Survey.* [WFS/2001A/3](#)

SP CAT

- Aparicio (IAC), *The Sagitario dwarf galaxy destruction.* [I10/2001A](#)
- Caon (IAC), *Exploring the links between ionized gas and peculiar stellar kinematics in early-type galaxies.* [I16/2001A](#)
- González (IAC), *Photometric redshift and star formation history on the ELAIS deep fields.* [I26/2001A](#)
- Gorgas (UCM), *A much-improved stellar library for stellar population synthesis.* [I7/2001A](#)
- Kidger (IAC), *A Test of a New Method for separating K giant and dwarfs.* [I20/2001A](#)
- López (IAC), *Planetary nebulae in the Virgo intracluster medium.* [I3/2001A](#)
- Martínez-Delgado (IAC), *The building-blocks of the Milky Way: Searching for dwarf galaxy remnants around globular clusters.* [I9/2001A](#)
- Montes (UCM), *Multi size continuous spectroscopy (MUSICOS) of flare stars.* [I8/2001A](#)

- Negueruela (Strasbourg), *The pre-main sequence population in the open globular cluster NGC 1893.* [I17/2001A](#)
- Sánchez (ING), *Search for the 2175 Å dust-absorption feature in red QSOs.* [I1/2001A](#)

Jacobus Kapteyn Telescope

UK PATT

- Davies (Cardiff), *Limits on the stellar content of Compact High Velocity Clouds (CHVCs).* [J/2001A/2](#)
- Davies (UKIRT), *Lightcurves of Near Earth Objects.* [J/2001A/9](#)
- Disney (Cardiff), *CCD Imaging of Gas Rich Low Surface Brightness galaxies found at 21cm.* [J/2001A/4](#)
- Fitzsimmons (QUB), *The size and composition of Near-Earth Asteroids.* [J/2000B/11](#). Long-term.
- Green (OU), *Physical properties of MUSES-C target asteroid, 1998 SF36.* [J/2001A/10](#)
- Hambly (Edinburgh), *Photometric Calibrators for the Palomar Sky Survey.* [J/2001A/6](#)
- Hynes (Southampton), *Weighing the Black Hole in XTE J1118+480.* [J/2001A/8](#)
- James (LJMU), *A survey of star formation in the local universe.* [J/2000A/11](#). Long-term.
- Knapen (Herts), *Star formation in arm and interarm environments in spiral galaxies.* [J/2001A/3](#)
- Marsh (Southampton), *Starspots on magnetic white dwarfs.* [J/2001A/11](#)
- Norton (OU), *Optical identification and outburst monitoring of transient X-ray binaries.* [J/2000B/8](#). Long-term and Override.
- Tanvir (Herts), *Rapid imaging of GRB error boxes and spectroscopy of GRB-related optical/IR transients.* [J/2001A/18](#). Override.

NL NFRA PC

- Orosz (Utrecht), *The mass of the black hole in the X-ray nova XTE J1118+480.* [i01an002](#)
- Schoenmakers (Dwingeloo), *R-band imaging of a sample of high-z giant radio galaxy candidates.* [i01an001](#)
- Vreeswijk (Amsterdam), *Rapid imaging of GRB error boxes and spectroscopy of GRB-related optical/IR transients.* [w01an008](#)

SP CAT

- Castro-Tirado (IAA/LAEFF), *Rapid detection of the optical counterparts of GRBs.* [J5/2001A](#). Override.
- Carraro (Padova), *Formation and evolution of the Milky Way.* [J14/2001A](#)
- Díaz (UAM), *Determination of the fundamental morphological parameters of the nearby active and normal galaxies.* [J4/2001A](#)
- Osoz (IAC), *Detection of the fast fluctuations in the gravitational lens Q0957+561.* [J2/2001A](#)
- Pérez (IAC), *Atlas of starburst galaxies through H recombination lines imaging.* [J3/2001A](#)
- Sánchez (ING), *NIR photometry of the B3-VLA quasar sample.* [J1/2001A](#)

Abbreviations:

CAT	Comité para la Asignación de Tiempo
ITP	International Time Programme
NFRA	Netherlands Foundation for Research in Astronomy
NL	The Netherlands
PATT	Panel for the Allocation of Telescope Time
PC	Programme Committee
SP	Spain
UK	The United Kingdom
WFS	Wide Field Survey

Contents

<i>Message from the Director</i>	1
<i>The Isaac Newton Group of Telescopes</i>	2
<i>The ING Board and the Instrumentation Working Group</i>	2
<i>The ING Newsletter</i>	2

THE ING WIDE FIELD IMAGING SURVEY

N A Walton, D J Lennon, M J Irwin, R G McMahon, <i>Science Highlights</i>	3
N A Walton, D J Lennon, R Greimel, M J Irwin, J R Lewis, G T Rixon, <i>The Wide Field Camera and Infrastructure</i>	7
R Greimel, J R Lewis, N A Walton, <i>Pipeline Data Processing</i>	9
R Rutten, <i>The Second Round of Wide Field Survey Observations</i>	11

SCIENCE

R Sharp, S Hodgkin, R McMahon, M Irwin, <i>High Redshift Quasars in the INT Wide Field Survey</i>	13
C Benn, S Sánchez, <i>Scientific Impact of Large Telescopes</i>	15
R L M Corradi, <i>Normal and Eccentric Dying Suns</i>	18

TELESCOPES AND INSTRUMENTATION

C Benn, A Longmore, R Myers, T Gregory, <i>NAOMI First Light</i>	21
A J Romanowsky, N G Douglas, M Arnaboldi, K Kuijken, <i>Extragalactic Planetary Nebula Kinematics with the WHT</i>	23
J Telting, K Dee, <i>New WHT Prime Focus Small Fibre Module</i>	26
T Augusteijn, <i>RoboDIMM</i>	27

OTHER NEWS FROM ING

J H Knapen, <i>Scientific Conference Organised by ING</i>	29
<i>News from the Roque</i>	29
<i>The ING High-Quality CCD Image Collection</i>	30
D Carlos Abrams, <i>News from the Computing Facilities Group</i>	31
J Telting, R Greimel, <i>Bug in AF2/WYFFOS Reduction Software</i>	31
<i>Other ING Publications and Information Services</i>	32
<i>Seminars Given at ING</i>	32
<i>Personnel Movements</i>	32

TELESCOPE TIME

D Lennon, <i>Applying for Time</i>	33
<i>Important Dates</i>	33
<i>Telescope Time Awards Semester 2001A</i>	34

Contacts at ING		Tel. (+34 922)	E-mail (@ing.iac.es)
Site Receptionist	<i>Mavi Hernández</i>	405655	mavi
Sea-level Office		425400	
Director	<i>René Rutten</i>	425420	rgmr
Personal Secretary to Director	<i>Rachael Miles</i>	425420	miles
Public Relations	<i>Javier Méndez</i>	425464	jma
Head of Administration	<i>Les Edwins</i>	425418	lie
Head of Astronomy	<i>Danny Lennon</i>	425441	djl
Head of Engineering	<i>Gordon Talbot</i>	425419	rgt
Telescope Scheduling	<i>Ian Skillen</i>	425439	wji
Service Programme	<i>Ian Skillen</i>	425439	wji
WHT Manager	<i>Chris Benn</i>	425432	crb
INT Manager	<i>Thomas Augusteijn</i>	425433	tau
JKT Manager	<i>Thomas Augusteijn</i>	425433	tau
Instrumentation Scientist	<i>Nic Walton</i>	425440	naw
Instrumentation Technical Contact	<i>Tom Gregory</i>	425444	tgregory
Freight	<i>Juan Martínez</i>	425414	juan



ISAAC NEWTON GROUP OF TELESCOPES

Roque de Los Muchachos Observatory, La Palma

