OMG Unified Modeling Language Specification

Version 1.3, June 1999

Copyright © 1997, 1998, 1999 Object Management Group, Inc.
Copyright © 1997, 1998, 1999 Hewlett-Packard Company
Copyright © 1997, 1998, 1999 IBM Corporation
Copyright © 1997, 1998, 1999 ICON Computing
Copyright © 1997, 1998, 1999 i-Logix
Copyright © 1997, 1998, 1999 IntelliCorp
Copyright © 1997, 1998, 1999 Electronic Data Services Corporation
Copyright © 1997, 1998, 1999 Microsoft Corporation
Copyright © 1997, 1998, 1999 ObjecTime Limited
Copyright © 1997, 1998, 1999 Oracle Corporation
Copyright © 1997, 1998, 1999 Platinum Technology, Inc.
Copyright © 1997, 1998, 1999 Ptech Inc.
Copyright © 1997, 1998, 1999 Rational Software Corporation
Copyright © 1997, 1998, 1999 Reich Technologies
Copyright © 1997, 1998, 1999 Softeam
Copyright © 1997, 1998, 1999 Sterling Software
Copyright © 1997, 1998, 1999 Taskon A/S
Copyright © 1997, 1998, 1999 Unisys Corporation

PATENT

The attention of adopters is directed to the possibility that compliance with or adoption of OMG specifications may require use of an invention covered by patent rights. OMG shall not be responsible for identifying patents for which a license may be required by any OMG specification, or for conducting legal inquiries into the legal validity or scope of those patents that are brought to its attention. OMG specifications are prospective and advisory only. Prospective users are responsible for protecting themselves against liability for infringement of patents.

NOTICE

The information contained in this document is subject to change without notice.

The material in this document details an Object Management Group, Inc. specification. This document does not represent a commitment to implement any portion of this specification in any companies' products.

GENERAL USE RESTRICTIONS

The owners of the copyright in the UML specifications version 1.3 hereby grant you a fully-paid up, non-exclusive, non-transferable, perpetual, worldwide license (without the right to sublicense), to create and distribute software and special purpose specifications which are based upon the UML specifications, and to use, copy, and distribute the UML specifications as provided under the Copyright Act; provided that: (1) both the copyright notice identified above and this permission notice appear on any copies of the UML specifications; (2) the use of the specifications is for informational purposes and will not be copied or posted on any network computer or broadcast in any media and will not be otherwise resold or transferred for commercial purposes; and (3) no modifications are made to the UML specifications themselves. This limited permission automatically terminates without notice if you breach any of these terms or conditions. Upon termination, you will destroy immediately any copies of the specifications in your possession or control.

Software developed under the terms of this license may claim compliance or conformance with UML version 1.3 if and only if the software compliance is of a nature fully matching the applicable compliance points as stated in the specifications. Software developed only partially matching the applicable compliance points may claim only that the software was based on the UML specifications, but may not claim compliance or conformance with any particular UML version. In the event that testing suites are implemented by Object Management Group, Inc., software developed using the UML speci-

cations may claim compliance or conformance with the specifications only if the software satisfactorily completes the testing suites.

Any unauthorized use of the UML specifications may violate copyright laws, trademark laws, and communications regulations and statutes.

DISCLAIMER OF WARRANTY

WHILE THE INFORMATION IN THIS PUBLICATION IS BELIEVED TO BE ACCURATE, THE UML SPECIFICATIONS ARE PROVIDED "AS IS" AND MAY CONTAIN ERRORS OR MISPRINTS. THE SPECIFICATIONS ARE PROVIDED FREE OF CHARGE OR AT A NOMINAL COST, AND ACCORDINGLY ARE PROVIDED ON AN "AS IS" BASIS, WITHOUT WARRANTY OF ANY KIND, INCLUDING WITHOUT LIMITATION THE WARRANTIES OF MERCHANTABILITY, FITNESS FOR A PARTICULAR PURPOSE AND NON-INFRINGEMENT. IN NO EVENT SHALL THE COPYRIGHT HOLDERS BE LIABLE FOR ERRORS CONTAINED HEREIN OR FOR INCIDENTAL OR CONSEQUENTIAL DAMAGES IN CONNECTION WITH THE FURNISHING, PERFORMANCE, OR USE OF THIS MATERIAL, EVEN IF ADVISED OF SUCH DAMAGES. The entire risk as to the quality and performance of software developed using the specifications is borne by you. This disclaimer of warranty constitutes an essential part of this Agreement.

RESTRICTED RIGHTS LEGEND

Use, duplication or disclosure by the U.S. Government subcontractor is subject to the restrictions set forth in subparagraph (c) (1) (ii) of The Rights in Technical Data and Computer Software Clause at DFARS 252.227-7013 or in subparagraph (c)(1) and (2) of the Commercial Computer Software - Restricted Rights clauses at 48 C.F.R. 52.227-19 or as specified in 48 C.F.R. 227-7202-2 of the DoD F.A.R. Supplement and its successors, or as specified in 48 C.F.R. 12.212 of the Federal Acquisition Regulations and its successors, as applicable. The specification owners are Rational Software Corporation, 18880 Homestead Road, Cupertino, CA 95014, and Object Management Group, Inc., 492 Old Connecticut Path, Framingham, MA 01701.

TRADEMARKS

OMG OBJECT MANAGEMENT GROUP, CORBA, CORBA ACADEMY, CORBA ACADEMY & DESIGN, THE INFORMATION BROKERAGE, OBJECT REQUEST BROKER, OMG IDL, CORBA FACILITIES, CORBA SERVICES, CORBANET, CORBAMED, CORBADOMAINS, GIOP, IIOP, OMA, CORBA THE GEEK, UNIFIED MODELING LANGUAGE, UML, and UML CUBE LOGO are registered trademarks or trademarks of the Object Management Group, Inc.

Rational Software is a trademark of Rational Software Corporation.

ISSUE REPORTING

All OMG specifications are subject to continuous review and improvement. As part of this process we encourage readers to report any ambiguities, inconsistencies, or inaccuracies they may find by completing the Issue Reporting Form at <http://www.omg.org/library/issuerpt.htm>.

Table of Contents

Table of Contents	v
Preface	xi
0.1 About the Unified Modeling Language (UML)	xi
0.2 About the Object Management Group (OMG)	xii
0.3 About This Document	xii
0.4 Compliance to the UML	xiv
0.5 Acknowledgements	xvii
0.6 References	xix
1. UML Summary	1-1
1.1 Overview	3
1.2 Primary Artifacts of the UML	3
1.3 Motivation to Define the UML	4
1.4 Goals of the UML	5
1.5 Scope of the UML	7
1.6 UML - Past, Present, and Future	11
2. UML Semantics	2-1
<i>Part 1 - Background</i>	3
2.1 Introduction	3
2.2 Language Architecture	4
2.3 Language Formalism	8
<i>Part 2 - Foundation</i>	13
2.4 Foundation Package	13

Table of Contents

2.5	Core	13
2.6	Extension Mechanisms	65
2.7	Data Types	75
Part 3 - Behavioral Elements		83
2.8	Behavioral Elements Package	83
2.9	Common Behavior	83
2.10	Collaborations	103
2.11	Use Cases	117
2.12	State Machines	129
2.13	Activity Graphs	159
Part 4 - General Mechanisms		171
2.14	Model Management	171
Index		185
3.	UML Notation Guide	3-1
Part 1 - Background		5
3.1	Introduction	5
Part 2 - Diagram Elements		7
3.2	Graphs and Their Contents	7
3.3	Drawing Paths	8
3.4	Invisible Hyperlinks and the Role of Tools	8
3.5	Background Information	8
3.6	String	9
3.7	Name	10
3.8	Label	11
3.9	Keywords	12
3.10	Expression	12
3.11	Note	14
3.12	Type-Instance Correspondence	15
Part 3 - Model Management		17
3.13	Package	17
3.14	Subsystem	19
3.15	Model	24
Part 4 - General Extension Mechanisms		27
3.16	Constraint and Comment	27
3.17	Element Properties	29

3.18	Stereotypes	30
	Part 5 - Static Structure Diagrams	33
3.19	Class Diagram	33
3.20	Object Diagram	34
3.21	Classifier	34
3.22	Class.	34
3.23	Name Compartment	36
3.24	List Compartment	37
3.25	Attribute	40
3.26	Operation	42
3.27	Type vs. Implementation Class	46
3.28	Interfaces	48
3.29	Parameterized Class (Template).	49
3.30	Bound Element.	51
3.31	Utility	53
3.32	Metaclass	53
3.33	Enumeration	54
3.34	Stereotype	54
3.35	Powertype	55
3.36	Class Pathnames.	55
3.37	Accessing or Importing a Package	56
3.38	Object.	58
3.39	Composite Object.	60
3.40	Association.	61
3.41	Binary Association.	61
3.42	Association End	65
3.43	Multiplicity	68
3.44	Qualifier	70
3.45	Association Class	71
3.46	N-ary Association	73
3.47	Composition	74
3.48	Link	78
3.49	Generalization	79
3.50	Dependency	83
3.51	Derived Element	86
3.52	InstanceOf	87

Table of Contents

Part 6 - Use Case Diagrams	89
3.53 Use Case Diagram	89
3.54 Use Case	91
3.55 Actor	92
3.56 Use Case Relationships	92
3.57 Actor Relationships	94
Part 7 - Sequence Diagrams	97
3.58 Kinds of Interaction Diagrams	97
3.59 Sequence Diagram	98
3.60 Object Lifeline	103
3.61 Activation.	104
3.62 Message and Stimulus	105
3.63 Transition Times	107
Part 8 - Collaboration Diagrams	109
3.64 Collaboration	109
3.65 Collaboration Diagram.	111
3.66 Pattern Structure.	114
3.67 Collaboration Contents.	116
3.68 Interactions.	117
3.69 Collaboration Roles	118
3.70 Multiobject.	121
3.71 Active object	122
3.72 Message and Stimulus	124
3.73 Creation/Destruction Markers	128
Part 9 - Statechart Diagrams	131
3.74 Statechart Diagram.	131
3.75 State	132
3.76 Composite States	135
3.77 Events.	137
3.78 Simple Transitions	140
3.79 Transitions to and from Concurrent States	141
3.80 Transitions to and from Composite States	142
3.81 Factored Transition Paths.	145
3.82 Submachine States	147
3.83 Synch States	149
Part 10 - Activity Diagrams	151

3.84	Activity Diagram	151
3.85	Action state	153
3.86	Subactivity state	154
3.87	Decisions	154
3.88	Swimlanes	155
3.89	Action-Object Flow Relationships	157
3.90	Control Icons	159
3.91	Synch States	162
3.92	Dynamic Invocation	162
3.93	Conditional Forks	163
	<i>Part 11 - Implementation Diagrams</i>	<i>165</i>
3.94	Component Diagram	165
3.95	Deployment Diagram	166
3.96	Node	168
3.97	Component	170
	<i>Index</i>	<i>173</i>
4.	UML Standard Profiles	4-1
	<i>Part 1 - UML Profile for Software Development Processes</i>	<i>3</i>
4.1	Overview	3
4.2	Introduction	3
4.3	Summary of Profile	3
4.4	Stereotypes and Notation	5
4.5	Well-Formedness Rules	8
	<i>Part 2 - UML Profile for Business Modeling</i>	<i>9</i>
4.6	Introduction	9
4.7	Summary of Profile	9
4.8	Stereotypes and Notation	10
4.9	Well-Formedness Rules	13
5.	UML CORBAfacility Interface Definition	5-1
5.1	Overview	3
5.2	Mapping of UML Semantics to Facility Interfaces	4
5.3	Facility Implementation Requirements	6
5.4	IDL Modules	7
6.	UML XMI DTD Specification	6-1
6.1	Overview	3

Table of Contents

6.2	Physical Metamodel	3
6.3	UML XMI DTD	23
7.	Object Constraint Language Specification	7-1
7.1	Overview	3
7.2	Introduction	4
7.3	Connection with the UML Metamodel	5
7.4	Basic Values and Types	7
7.5	Objects and Properties	11
7.6	Collection Operations	21
7.7	The Standard OCL Package	26
7.8	Predefined OCL Types	27
7.9	Grammar	47
A.	UML Standard Elements	A-1
B.	OMG Modeling Glossary	B-1

Preface

0.1 About the Unified Modeling Language (UML)

The Unified Modeling Language (UML) provides system architects working on object analysis and design with one consistent language for specifying, visualizing, constructing, and documenting the artifacts of software systems, as well as for business modeling.

This specification represents the convergence of best practices in the object-technology industry. UML is the proper successor to the object modeling languages of three previously leading object-oriented methods (Booch, OMT, and OOSE). The UML is the union of these modeling languages and more, since it includes additional expressiveness to handle modeling problems that these methods did not fully address.

One of the primary goals of UML is to advance the state of the industry by enabling object visual modeling tool interoperability. However, in order to enable meaningful exchange of model information between tools, agreement on semantics and notation is required. UML meets the following requirements:

- Formal definition of a common object analysis and design (OA&D) metamodel to represent the semantics of OA&D models, which include static models, behavioral models, usage models, and architectural models.
- IDL specifications for mechanisms for model interchange between OA&D tools. This document includes a set of IDL interfaces that support dynamic construction and traversal of a user model.
- A human-readable notation for representing OA&D models. This document defines the UML notation, an elegant graphic syntax for consistently expressing the UML's rich semantics. Notation is an essential part of OA&D modeling and the UML.

0.2 About the Object Management Group (OMG)

The Object Management Group, Inc. (OMG) is an international organization supported by over 800 members, including information system vendors, software developers and users. Founded in 1989, the OMG promotes the theory and practice of object-oriented technology in software development. The organization's charter includes the establishment of industry guidelines and object management specifications to provide a common framework for application development. Primary goals are the reusability, portability, and interoperability of object-based software in distributed, heterogeneous environments. Conformance to these specifications will make it possible to develop a heterogeneous applications environment across all major hardware platforms and operating systems.

OMG's objectives are to foster the growth of object technology and influence its direction by establishing the Object Management Architecture (OMA). The OMA provides the conceptual infrastructure upon which all OMG specifications are based.

Contact the Object Management Group, Inc. at:

OMG Headquarters
492 Old Connecticut Path
Framingham, MA 01701
USA
Tel: +1-508-820 4300
Fax: +1-508-820 4303
pubs@omg.org
<http://www.omg.org>

OMG's adoption of the UML specification reduces the degree of confusion within the industry surrounding modeling languages. It settles unproductive arguments about method notations and model interchange mechanisms and allows the industry to focus on higher leverage, more productive activities. Additionally, it enables semantic interchange between visual modeling tools.

0.3 About This Document

This document is intended primarily as a precise and self-consistent definition of the UML's semantics and notation. The primary audience of this document consists of the Object Management Group, standards organizations, book authors, trainers, and tool builders. The authors assume familiarity with object-oriented analysis and design methods. The document is not written as an introductory text on building object models for complex systems, although it could be used in conjunction with other materials or instruction. The document will become more approachable to a broader audience as additional books, training courses, and tools that apply to UML become available.

The Unified Modeling Language specification defines compliance to the UML, covers the architectural alignment with other technologies, and is comprised of the following topics:

0.3 About This Document

UML Summary (Chapter 1) - provides an introduction to the UML, discussing motivation and history.

UML Semantics (Chapter 2) - defines the semantics of the Unified Modeling Language. The UML is layered architecturally and organized by packages. Within each package, the model elements are defined in the following terms:

1. Abstract syntax	UML class diagrams are used to present the UML metamodel, its concepts (metaclasses), relationships, and constraints. Definitions of the concepts are included.
2. Well-formedness rules	The rules and constraints on valid models are defined. The rules are expressed in English prose and in a precise Object Constraint Language (OCL). OCL is a specification language that uses logic for specifying invariant properties of systems comprising sets and relationships between sets.
3. Semantics	The semantics of model usage are described in English prose.

UML Notation Guide (Chapter 3) - specifies the graphic syntax for expressing the semantics described by the UML metamodel. Consequently, the UML Notation Guide's chapter should be read in conjunction with the UML Semantics chapter.

UML Standard Profiles (Chapter 4) - defines the UML Profile for Software Development Processes and the UML Profile for Business Modeling.

UML CORBAfacility Interface Definition (Chapter 5) - uses CORBA IDL to specify a repository that enables the creation, storage and manipulation of UML models.

UML XMI DTD Specification (Chapter 6) - uses XML DTD to define a physical mechanism for interchanging UML models that conform to the UML metamodel.

Object Constraint Language Specification (Chapter 7) - defines the Object Constraint Language (OCL) syntax, semantics, and grammar. All OCL features are described in terms of concepts defined in the UML Semantics.

In addition, there is appendix of Standard Elements that defines standard stereotypes, constraints and tagged values for UML, and a glossary of terms.

0.3.1 Dependencies Between Chapters

UML Semantics (Chapter 2) can stand on its own, relative to the others, with the exception of the *OCL Specification*. The semantics depends upon OCL for the specification of its well-formedness rules.

The *UML Notation Guide*, *UML CORBAfacility Interface Definition* and *UML XMI DTD Specification* all depend on the UML Semantics. Specifying these as separate standards will permit their evolution in the most flexible way, even though they are not completely independent.

The specifications in the *UML Standard Profiles* depend on both the notation and semantics chapters.

0.4 Compliance to the UML

The UML and corresponding facility interface definition are comprehensive. However, these specifications are packaged so that subsets of the UML and facility can be implemented without breaking the integrity of the language. The UML Semantics is packaged as follows:

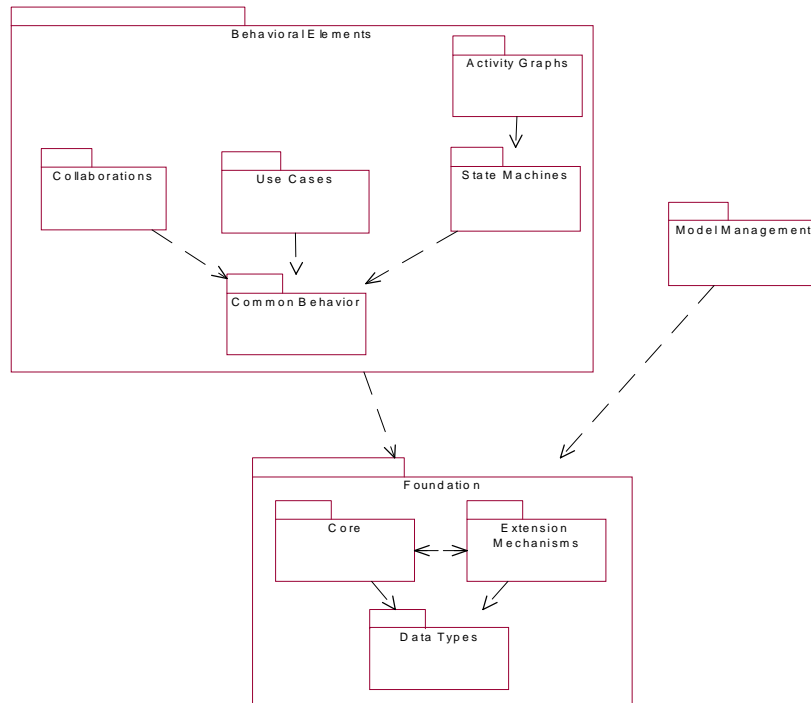

Figure 0-1 UML Class Diagram Showing Package Structure

This packaging shows the semantic dependencies between the UML model elements in the different packages. The IDL in the facility is packaged almost identically. The notation is also “packaged” along the lines of diagram type. Compliance of the UML is thus defined along the lines of semantics, notation, and IDL.

Even if the compliance points are decomposed into more fundamental units, vendors implementing UML may choose not to fully implement this packaging of definitions, while still faithfully implementing some of the UML definitions. However, vendors who want to precisely declare their compliance to UML should refer to the precise language defined herein, and not loosely say they are “UML compliant.”

0.4.1 Compliance to the UML Semantics

The basic units of compliance are the packages defined in the UML metamodel. The full metamodel includes the corresponding semantic rigor defined in the UML Semantics chapter of this specification.

0.4 Compliance to the UML

The class diagram illustrates the package dependencies, which are also summarized in the table below.

Table 0-1 Metamodel Packages

Package	Prerequisite Packages
DataTypes	
Core	DataTypes, Extension Mechanisms
Extension Mechanisms	Core, DataTypes
Common Behavior	Foundation
State Machines	Common Behavior, Foundation
Activity Graphs	State Machines, Foundation
Collaborations	Common Behavior, Foundation
Use Cases	Common Behavior, Foundation
Model Management	Foundation

Complying with a package requires complying with the prerequisite package.

The semantics are defined in an implementation language-independent way. An implementation of the semantics, without consistent interface and implementation choices, does not guarantee tool interoperability. See the *OA&D CORBAfacility Interface Definition* (Chapter 5).

In addition to the above packages, compliance to a given metamodel package must load or know about the predefined UML standard elements (i.e., values for all predefined stereotypes, tags, and constraints). These are defined throughout the semantics and notation documents and summarized in the UML Standard Elements appendix. The predefined constraint values must be enforced consistent with their definitions. Having tools know about the standard elements is necessary for the full language and to avoid the definition of user-defined elements that conflict with the standard UML elements. Compliance to the UML Standard Elements and UML Standard Profiles is distinct from the UML Semantics, so not all tools need to know about the UML Standard Elements and UML Standard Profiles.

For any implementation of UML, it is optional that the tool implements the Object Constraint Language. A vendor conforming to OCL support must support the following:

- Validate and store syntactically correct OCL expressions as values for UML data types.
- Be able to perform a full type check on the object constraint expression. This check will test whether all features used in the expression are actually defined in the UML model and used correctly.

All tools conforming to the UML semantics are expected to conform to the following aspects of the semantics:

- abstract syntax (i.e., the concepts, valid relationships, and constraints expressed in the corresponding class diagrams),
- well-formedness rules, and
- semantics of model usage.

However, vendors are expected to apply some discretion on how strictly the well-formedness rules are enforced. Tools should be able to report on well-formedness violations, but not necessarily force all models to be well formed. Incomplete models are common during certain phases of the development lifecycle, so they should be permitted. See the *OA&D CORBAfacility Interface Definition* (Chapter 5 of this specification) for its treatment of well-formedness exception handling, as an example of a technique to report well-formedness violations.

0.4.2 Compliance to the UML Notation

The UML notation is an essential element of the UML to enable communication between team members. Compliance to the notation is optional, but the semantics are not very meaningful without a consistent way of expressing them.

Notation compliance is defined along the lines of the UML Diagrams types: use case, class, statechart, activity graph, sequence, collaboration, component, and deployment diagrams.

If the notation is implemented, a tool must enforce the underlying semantics and maintain consistency between diagrams if the diagrams share the same underlying model. By this definition, a simple "drawing tool" cannot be compliant to the UML notation.

There are many optional notation adornments. For example, a richly adorned class icon may include an embedded stereotype icon, a list of properties (tagged values and metamodel attributes), constraint expressions, attributes with visibilities indicated, and operations with full signatures. Complying with class diagram support implies the ability to support all of the associated adornments.

Compliance to the notation in the *UML Standard Profiles* is described separately.

0.4.3 Compliance to the UML Standard Profiles

Vendors should specify whether they support each of the UML Standard Profiles or not. Compliance to a profile means knowledge and enforcement of the semantics and corresponding notation.

0.4.4 Compliance to the UML CORBAfacility Interface Definition

The IDL modules defined in the UML CORBAfacility parallel the packages in the semantic metamodel. The exception to this is that DataTypes and Extension Mechanisms have been merged in with the core for the facility. Except for this, a CORBAfacility implementing the interface modules has the same compliance point options as described in "Compliance to the UML Semantics" listed above.

0.4.5 Compliance to the UML XMI DTD Specification

The DTD defined in the UML XMI DTD Specification parallel the packages in the semantic metamodel. The exception to this is that DataTypes and Extension Mechanisms have been merged in with the core for the facility. Except for this, an implementation of the XMI DTD has the same compliance point options as described in "Compliance to the UML Semantics" listed above.

0.4.6 Summary of Compliance Points

Table 0-2 Summary of Compliance Points

Compliance Point	Valid Options
Core	no/incomplete, complete, complete including IDL and/or XMI DTD
Common Behavior	no/incomplete, complete, complete including IDL and/or XMI DTD
State Machines	no/incomplete, complete, complete including IDL and/or XMI DTD
Activity Graphs	no/incomplete, complete, complete including IDL and/or XMI DTD
Collaboration	no/incomplete, complete, complete including IDL and/or XMI DTD
Use Cases	no/incomplete, complete, complete including IDL and/or XMI DTD
Model Management	no/incomplete, complete, complete including IDL and/or XMI DTD
UML Profiles	no/incomplete, complete, complete including IDL and/or XMI DTD
Use Case diagram	no/incomplete, complete
Class diagram	no/incomplete, complete
Statechart diagram	no/incomplete, complete
Activity Graph diagram	no/incomplete, complete
Sequence diagram	no/incomplete, complete
Collaboration diagram	no/incomplete, complete
Component diagram	no/incomplete, complete
Deployment diagram	no/incomplete, complete
UML Profile for Software Development Processes	no/incomplete, complete
UML Profile for Business Modeling	no/incomplete, complete
OCL	no/incomplete, complete

0.5 Acknowledgements

The UML was crafted through the dedicated efforts of individuals and companies who find UML strategic to their future. This section acknowledges the efforts of these individuals who contributed to defining UML.

UML Core Team

The following persons were members of the core development team for the UML proposal or served on the UML Revision Task Force:

Data Access Corporation: Tom Digre

Electronic Data Systems Corporation: Cris Kobryn, Joaquin Miller

Enea Data: Karin Palmkvist

Hewlett-Packard Company: Martin Griss

IBM Corporation: Steve Brodsky, Steve Cook, Jos Warmer

I-Logix: Eran Gery, David Harel

ICON Computing: Desmond D'Souza

IntelliCorp and James Martin & Co.: Conrad Bock, James Odell

OAo Technology Solutions: Ed Seidewitz

ObjecTime Limited: John Hogg, Bran Selic

Oracle Corporation: Guus Ramackers

PLATINUM Technology Inc.: Dilhar DeSilva

Rational Software: Grady Booch, Ed Eykholt, Ivar Jacobson, Gunnar Overgaard, Jim Rumbaugh

SAP: Oliver Wiegert

SOFTEAM: Philippe Desfray

Sterling Software: John Cheesman, Keith Short

Taskon: Trygve Reenskaug

Unisys Corporation: Sridhar Iyengar, GK Khalsa

UML 1.1 Semantics Task Force

During the final submission phase, a team was formed to focus on improving the formality of the UML 1.0 semantics, as well as incorporating additional ideas from the partners. Under the leadership of Cris Kobryn, this team was very instrumental in reconciling diverse viewpoints into a consistent set of semantics, as expressed in the revised *UML Semantics*. Other members of this team were Dilhar DeSilva, Martin Griss, Sridhar Iyengar, Eran Gery, James Odell, Gunnar Overgaard, Karin Palmkvist, Guus Ramackers, Bran Selic, and Jos Warmer. Grady Booch, Ivar Jacobson, and Jim Rumbaugh also provided their expertise to the team.

UML Revision Task Force

After the adoption of the UML 1.1 proposal by the OMG membership in November, 1997, the OMG chartered a revision task force (RTF) to deal with bugs, inconsistencies, and other problems that could be handled without greatly expanding the scope of the original proposal. The RTF accepted public comments submitted to the OMG after adoption of the proposal. This document containing UML version 1.3 is the result of the work of the UML RTF. The results have been issued in several preliminary versions with minor changes expected in the final version. If you have a preliminary version of the specification, you can obtain an updated version from the OMG web site at www.omg.org.

Contributors and Supporters

We also acknowledge the contributions, influence, and support of the following individuals.

Jim Amsden, Hernan Astudillo, Colin Atkinson, Dave Bernstein, Philip A. Bernstein, Michael Blaha, Mike Bradley, Ray Buhr, Gary Cernosek, James Cerrato, Michael Jesse Chonoles, Magnus Christerson, Dai Clegg, Peter Coad, Derek Coleman, Ward Cunningham, Raj Datta, Mike Devlin, Philippe Desfray, Bruce Douglass, Staffan Ehnebom, Maria Ericsson, Johannes Ernst, Don Firesmith, Martin Fowler, Adam Frankl, Eric Gamma, Dipayan Gangopadhyay, Garth Gullekson, Rick Hargrove, Tim Harrison, Richard Helm, Brian Henderson-Sellers, Michael Hirsch, Bob Hodges, Glenn Hollowell, Yves Holvoet, Jon Hopkins, John Hsia, Ralph Johnson, Stuart Kent, Anneke Kleppe, Philippe Kruchten, Paul Kyzivat, Martin Lang, Grant Larsen, Reed Letsinger, Mary Loomis, Jeff MacKay, Bev Macmaster, Robert Martin, Terrie McDaniel, Jim McGee, Bertrand Meyer, Mike Meier, Randy Messer, Greg Meyers, Fred Mol, Luis Montero, Paul Moskowitz, Andy Moss, Jan Pachl, Paul Patrick, Woody Pidcock, Bill Premerlani, Jeff Price, Jerri Pries, Terry Quatrani, Mats Rahm, George Reich, Rich Reitman, Rudolf M. Riess, Erick Rivas, Kenny Rubin, Bernhard Rumpe, Jim Rye, Danny Sabbah, Tom Schultz, Gregson Siu, Jeff Sutherland, Dan Tasker, Dave Tropeano, Andy Trice, Dan Uhlar, John Vlissides, Larry Wall, Paul Ward, Oliver Wiegert, Alan Wills, Rebecca Wirfs-Brock, Bryan Wood, Ed Yourdon, and Steve Zeigler.

0.6 References

[Bock/Odell 94]	C. Bock and J. Odell, "A Foundation For Composition," <i>Journal of Object-Oriented Programming</i> , October 1994.
[Booch et al. 99]	Grady Booch, James Rumbaugh, and Ivar Jacobson, <i>The Unified Modeling Language User Guide</i> , Addison Wesley, 1999.
[Cook 94]	S. Cook and J. Daniels, <i>Designing Object Systems: Object-oriented Modelling with Syntropy</i> , Prentice-Hall Object-Oriented Series, 1994.
[D'Souza 99]	D. D'Souza and A. Wills, <i>Objects, Components and Frameworks with UML: The Catalysis Approach</i> , Addison-Wesley, 1999.
[Fowler 97]	M. Fowler with K. Scott, <i>UML Distilled: Applying the Standard Object Modeling Language</i> , Addison-Wesley, 1997.
[Griss 96]	M. Griss, "Domain Engineering And Variability In The Reuse-Driven Software Engineering Business," <i>Object Magazine</i> . December 1996.

Preface

[Harel 87]	D. Harel, "Statecharts: A Visual Formalism for Complex Systems," <i>Science of Computer Programming</i> 8, (1987), pp. 231-274.
[Harel 96a]	D. Harel and E. Gery, "Executable Object Modeling with Statecharts," <i>Proc. 18th Int. Conf. Soft. Eng.</i> , Berlin, IEEE Press, March, 1996, pp. 246-257.
[Harel 96b]	D. Harel and A. Naamad, "The STATEMATE Semantics of Statecharts," <i>ACM Trans. Soft. Eng. Method</i> 5:4, October 1996.
[Jacobson et al. 99]	Ivar Jacobson, Grady Booch, and James Rumbaugh, <i>The Unified Software Development Process</i> , Addison Wesley, 1999.
[Malan 96]	R. Malan, D. Coleman, R. Letsinger et al, "The Next Generation of Fusion," Fusion Newsletter, October 1996.
[Martin/Odell 95]	J. Martin and J. Odell, <i>Object-Oriented Methods, A Foundation</i> , Prentice Hall, 1995
[Ramackers 95]	Ramackers, G. and Clegg, D., "Object Business Modelling, requirements and approach" in Sutherland, J. and Patel, D. (eds.), <i>Proceedings of the OOPSLA95 Workshop on Business Object Design and Implementation</i> , Springer Verlag, publication pending.
[Ramackers 96]	Ramackers, G. and Clegg, D., "Extended Use Cases and Business Objects for BPR," ObjectWorld UK '96, London, June 18-21, 1996.
[Rumbaugh et al. 99]	Jim Rumbaugh, Ivar Jacobson, and Grady Booch, <i>The Unified Modeling Language Reference Manual</i> , Addison Wesley, 1999.
[Selic et al. 94]	B. Selic, G. Gullekson, and P. Ward, <i>Real-Time Object-Oriented Modeling</i> , John Wiley & Sons, 1994.
[Warmer et al. 99]	J. Warmer and A. Kleppe, <i>The Object Constraint Language: Precise Modeling with UML</i> , Addison-Wesley, 1999.
[UML Web Sites]	www.omg.org www.rational.com/uml uml.shl.com

UML Summary

1

The UML Summary provides an introduction to the UML, discussing its motivation and history.

Contents

1.1 Overview	1-3
1.2 Primary Artifacts of the UML	1-3
1.3 Motivation to Define the UML	1-4
1.4 Goals of the UML	1-5
1.5 Scope of the UML	1-7
1.6 UML - Past, Present, and Future	1-11

1 UML Summary

1.1 Overview

The Unified Modeling Language (UML) is a language for specifying, visualizing, constructing, and documenting the artifacts of software systems, as well as for business modeling and other non-software systems. The UML represents a collection of the best engineering practices that have proven successful in the modeling of large and complex systems.

1.2 Primary Artifacts of the UML

What are the primary artifacts of the UML? This can be answered from two different perspectives: the UML definition itself and how it is used to produce project artifacts.

1.2.1 UML-defining Artifacts

To aid the understanding of the artifacts that constitute the Unified Modeling Language itself, this document consists of chapters describing UML Semantics, UML Notation Guide, and UML Standard Profiles.

1.2.2 Development Project Artifacts

The choice of what models and diagrams one creates has a profound influence upon how a problem is attacked and how a corresponding solution is shaped. Abstraction, the focus on relevant details while ignoring others, is a key to learning and communicating. Because of this:

- Every complex system is best approached through a small set of nearly independent views of a model. No single view is sufficient.
- Every model may be expressed at different levels of fidelity.
- The best models are connected to reality.

In terms of the views of a model, the UML defines the following graphical diagrams:

- use case diagram
- class diagram
- behavior diagrams:
 - statechart diagram
 - activity diagram
 - interaction diagrams:
 - sequence diagram
 - collaboration diagram
- implementation diagrams:
 - component diagram
 - deployment diagram

1 UML Summary

Although other names are sometimes given to these diagrams, this list constitutes the canonical diagram names.

These diagrams provide multiple perspectives of the system under analysis or development. The underlying model integrates these perspectives so that a self-consistent system can be analyzed and built. These diagrams, along with supporting documentation, are the primary artifacts that a modeler sees, although the UML and supporting tools will provide for a number of derivative views. These diagrams are further described in the UML Notation Guide (Chapter 3 of this specification).

A frequently asked question has been: Why doesn't UML support data-flow diagrams? Simply put, data-flow and other diagram types that were not included in the UML do not fit as cleanly into a consistent object-oriented paradigm. Activity diagrams and collaboration diagrams accomplish much of what people want from DFDs, and then some. Activity diagrams are also useful for modeling workflow.

1.3 Motivation to Define the UML

This section describes several factors motivating the UML and includes why modeling is essential. It highlights a few key trends in the software industry and describes the issues caused by divergence of modeling approaches.

1.3.1 Why We Model

Developing a model for an industrial-strength software system prior to its construction or renovation is as essential as having a blueprint for large building. Good models are essential for communication among project teams and to assure architectural soundness. We build models of complex systems because we cannot comprehend any such system in its entirety. As the complexity of systems increase, so does the importance of good modeling techniques. There are many additional factors of a project's success, but having a rigorous modeling language standard is one essential factor. A modeling language must include:

- Model elements — fundamental modeling concepts and semantics
- Notation — visual rendering of model elements
- Guidelines — idioms of usage within the trade

In the face of increasingly complex systems, visualization and modeling become essential. The UML is a well-defined and widely accepted response to that need. It is the visual modeling language of choice for building object-oriented and component-based systems.

1.3.2 Industry Trends in Software

As the strategic value of software increases for many companies, the industry looks for techniques to automate the production of software. We look for techniques to improve quality and reduce cost and time-to-market. These techniques include component technology, visual programming, patterns, and frameworks. We also seek techniques to manage the complexity of systems as they increase in scope and scale. In particular, we recognize the need to solve

recurring architectural problems, such as physical distribution, concurrency, replication, security, load balancing, and fault tolerance. Development for the worldwide web makes some things simpler, but exacerbates these architectural problems.

Complexity will vary by application domain and process phase. One of the key motivations in the minds of the UML developers was to create a set of semantics and notation that adequately addresses all scales of architectural complexity, across all domains.

1.3.3 Prior to Industry Convergence

Prior to the UML, there was no clear leading modeling language. Users had to choose from among many similar modeling languages with minor differences in overall expressive power. Most of the modeling languages shared a set of commonly accepted concepts that are expressed slightly differently in various languages. This lack of agreement discouraged new users from entering the object technology market and from doing object modeling, without greatly expanding the power of modeling. Users longed for the industry to adopt one, or a very few, broadly supported modeling languages suitable for general-purpose usage.

Some vendors were discouraged from entering the object modeling area because of the need to support many similar, but slightly different, modeling languages. In particular, the supply of add-on tools has been depressed because small vendors cannot afford to support many different formats from many different front-end modeling tools. It is important to the entire object industry to encourage broadly based tools and vendors, as well as niche products that cater to the needs of specialized groups.

The perpetual cost of using and supporting many modeling languages motivated many companies producing or using object technology to endorse and support the development of the UML.

While the UML does not guarantee project success, it does improve many things. For example, it significantly lowers the perpetual cost of training and retooling when changing between projects or organizations. It provides the opportunity for new integration between tools, processes, and domains. But most importantly, it enables developers to focus on delivering business value and gives them a paradigm to accomplish this.

1.4 Goals of the UML

The primary design goals of the UML are as follows:

- Provide users with a ready-to-use, expressive visual modeling language to develop and exchange meaningful models.
- Furnish extensibility and specialization mechanisms to extend the core concepts.
- Support specifications that are independent of particular programming languages and development processes.
- Provide a formal basis for understanding the modeling language.
- Encourage the growth of the object tools market.
- Support higher-level development concepts such as components, collaborations, frameworks and patterns.

- Integrate best practices.

These goals are discussed in detail below.

Provide users with a ready-to-use, expressive visual modeling language to develop and exchange meaningful models

It is important that the Object Analysis and Design (OA&D) standard supports a modeling language that can be used "out of the box" to do normal general-purpose modeling tasks. If the standard merely provides a meta-meta-description that requires tailoring to a particular set of modeling concepts, then it will not achieve the purpose of allowing users to exchange models without losing information or without imposing excessive work to map their models to a very abstract form. The UML consolidates a set of core modeling concepts that are generally accepted across many current methods and modeling tools. These concepts are needed in many or most large applications, although not every concept is needed in every part of every application. Specifying a meta-meta-level format for the concepts is not sufficient for model users, because the concepts must be made concrete for real modeling to occur. If the concepts in different application areas were substantially different, then such an approach might work, but the core concepts needed by most application areas are similar and should be supported directly by the standard without the need for another layer.

Furnish extensibility and specialization mechanisms to extend the core concepts

OMG expects that the UML will be tailored as new needs are discovered and for specific domains. At the same time, we do not want to force the common core concepts to be redefined or re-implemented for each tailored area. Therefore, we believe that the extension mechanisms should support deviations from the common case, rather than being required to implement the core modeling concepts themselves. The core concepts should not be changed more than necessary. Users need to be able to

- build models using core concepts without using extension mechanisms for most normal applications,
- add new concepts and notations for issues not covered by the core,
- choose among variant interpretations of existing concepts, when there is no clear consensus, and
- specialize the concepts, notations, and constraints for particular application domains.

Support specifications that are independent of particular programming languages and development processes

The UML must and can support all reasonable programming languages. It also must and can support various methods and processes of building models. The UML can support multiple programming languages and development methods without excessive difficulty.

Provide a formal basis for understanding the modeling language

Because users will use formality to help understand the language, it must be both precise and approachable; a lack of either dimension damages its usefulness. The formalisms must not require excessive levels of indirection or layering, use of low-level mathematical notations distant from the modeling domain, such as set-theoretic notation, or operational definitions that

are equivalent to programming an implementation. The UML provides a formal definition of the static format of the model using a metamodel expressed in UML class diagrams. This is a popular and widely accepted formal approach for specifying the format of a model and directly leads to the implementation of interchange formats. UML expresses well-formedness constraints in precise natural language plus Object Constraint Language expressions. UML expresses the operational meaning of most constructs in precise natural language. The fully formal approach taken to specify languages such as Algol-68 was not approachable enough for most practical usage.

Encourage the growth of the object tools market

By enabling vendors to support a standard modeling language used by most users and tools, the industry benefits. While vendors still can add value in their tool implementations, enabling interoperability is essential. Interoperability requires that models can be exchanged among users and tools without loss of information. This can only occur if the tools agree on the format and meaning of all of the relevant concepts. Using a higher meta-level is no solution unless the mapping to the user-level concepts is included in the standard.

Support higher-level development concepts such as components, collaborations, frameworks, and patterns

Clearly defined semantics of these concepts is essential to reap the full benefit of object-orientation and reuse. Defining these within the holistic context of a modeling language is a unique contribution of the UML.

Integrate best practices

A key motivation behind the development of the UML has been to integrate the best practices in the industry, encompassing widely varying views based on levels of abstraction, domains, architectures, life cycle stages, implementation technologies, etc. The UML is indeed such an integration of best practices.

1.5 Scope of the UML

The Unified Modeling Language (UML) is a language for specifying, constructing, visualizing, and documenting the artifacts of a software-intensive system.

First and foremost, the Unified Modeling Language fuses the concepts of Booch, OMT, and OOSE. The result is a single, common, and widely usable modeling language for users of these and other methods.

Second, the Unified Modeling Language pushes the envelope of what can be done with existing methods. As an example, the UML authors targeted the modeling of concurrent, distributed systems to assure the UML adequately addresses these domains.

Third, the Unified Modeling Language focuses on a standard modeling language, not a standard process. Although the UML must be applied in the context of a process, it is our experience that different organizations and problem domains require different processes. (For example, the development process for shrink-wrapped software is an interesting one, but building shrink-wrapped software is vastly different from building hard-real-time avionics systems upon which lives depend.) Therefore, the efforts concentrated first on a common metamodel (which unifies

semantics) and second on a common notation (which provides a human rendering of these semantics). The UML authors promote a development process that is use-case driven, architecture centric, and iterative and incremental.

The UML specifies a modeling language that incorporates the object-oriented community's consensus on core modeling concepts. It allows deviations to be expressed in terms of its extension mechanisms. The Unified Modeling Language provides the following:

- Semantics and notation to address a wide variety of contemporary modeling issues in a direct and economical fashion.
- Semantics to address certain expected future modeling issues, specifically related to component technology, distributed computing, frameworks, and executability.
- Extensibility mechanisms so individual projects can extend the metamodel for their application at low cost. We don't want users to directly change the UML metamodel.
- Extensibility mechanisms so that future modeling approaches could be grown on top of the UML.
- Semantics to facilitate model interchange among a variety of tools.
- Semantics to specify the interface to repositories for the sharing and storage of model artifacts.

1.5.1 Outside the Scope of the UML

Programming Languages

The UML, a visual modeling language, is not intended to be a visual programming language, in the sense of having all the necessary visual and semantic support to replace programming languages. The UML is a language for visualizing, specifying, constructing, and documenting the artifacts of a software-intensive system, but it does draw the line as you move toward code. For example, complex branches and joins are better expressed in a textual programming language. The UML does have a tight mapping to a family of object languages so that you can get the best of both worlds.

Tools

Standardizing a language is necessarily the foundation for tools and process. Tools and their interoperability are very dependent on a solid semantic and notation definition, such as the UML provides. The UML defines a semantic metamodel, not a tool interface, storage, or run-time model, although these should be fairly close to one another.

The UML documents do include some tips to tool vendors on implementation choices, but do not address everything needed. For example, they don't address topics like diagram coloring, user navigation, animation, storage/implementation models, or other features.

Process

Many organizations will use the UML as a common language for its project artifacts, but will use the same UML diagram types in the context of different processes. The UML is intentionally process independent, and defining a standard process was not a goal of the UML or OMG's RFP.

The UML authors do recognize the importance of process. The presence of a well-defined and well-managed process is often a key discriminator between hyperproductive projects and unsuccessful ones. The reliance upon heroic programming is not a sustainable business practice. A process

- provides guidance as to the order of a team's activities,
- specifies what artifacts should be developed,
- directs the tasks of individual developers and the team as a whole, and
- offers criteria for monitoring and measuring a project's products and activities.

Processes by their very nature must be tailored to the organization, culture, and problem domain at hand. What works in one context (shrink-wrapped software development, for example) would be a disaster in another (hard-real-time, human-rated systems, for example). The selection of a particular process will vary greatly, depending on such things as problem domain, implementation technology, and skills of the team.

Booch, OMT, OOSE, and many other methods have well-defined processes, and the UML can support most methods. There has been some convergence on development process practices, but there is not yet consensus for standardization. What will likely result is general agreement on best practices and potentially the embracing of a process framework, within which individual processes can be instantiated. Although the UML does not mandate a process, its developers have recognized the value of a use-case driven, architecture-centric, iterative, and incremental process, so were careful to enable (but not require) this with the UML.

1.5.2 Comparing UML to Other Modeling Languages

It should be made clear that the Unified Modeling Language is not a radical departure from Booch, OMT, or OOSE, but rather the legitimate successor to all three. This means that if you are a Booch, OMT, or OOSE user today, your training, experience, and tools will be preserved, because the Unified Modeling Language is a natural evolutionary step. The UML will be equally easy to adopt for users of many other methods, but their authors must decide for themselves whether to embrace the UML concepts and notation underneath their methods.

The Unified Modeling Language is more expressive yet cleaner and more uniform than Booch, OMT, OOSE, and other methods. This means that there is value in moving to the Unified Modeling Language, because it will allow projects to model things they could not have done before. Users of most other methods and modeling languages will gain value by moving to the UML, since it removes the unnecessary differences in notation and terminology that obscure the underlying similarities of most of these approaches.

With respect to other visual modeling languages, including entity-relationship modeling, BPR flow charts, and state-driven languages, the UML should provide improved expressiveness and holistic integrity.

Users of existing methods will experience slight changes in notation, but this should not take much relearning and will bring a clarification of the underlying semantics. If the unification goals have been achieved, UML will be an obvious choice when beginning new projects, especially as the availability of tools, books, and training becomes widespread. Many visual modeling tools support existing notations, such as Booch, OMT, OOSE, or others, as views of an underlying model; when these tools add support for UML (as some already have) users will enjoy the benefit of switching their current models to the UML notation without loss of information.

Existing users of any object method can expect a fairly quick learning curve to achieve the same expressiveness as they previously knew. One can quickly learn and use the basics productively. More advanced techniques, such as the use of stereotypes and properties, will require some study since they enable very expressive and precise models needed only when the problem at hand requires them.

1.5.3 Features of the UML

The goals of the unification efforts were to keep it simple, to cast away elements of existing Booch, OMT, and OOSE that didn't work in practice, to add elements from other methods that were more effective, and to invent new only when an existing solution was not available. Because the UML authors were in effect designing a language (albeit a graphical one), they had to strike a proper balance between minimalism (everything is text and boxes) and over-engineering (having an icon for every conceivable modeling element). To that end, they were very careful about adding new things, because they didn't want to make the UML unnecessarily complex. Along the way, however, some things were found that were advantageous to add because they have proven useful in practice in other modeling.

There are several new concepts that are included in UML, including

- extensibility mechanisms (stereotypes, tagged values, and constraints),
- threads and processes,
- distribution and concurrency (e.g., for modeling ActiveX/DCOM and CORBA),
- patterns/collaborations,
- activity diagrams (for business process modeling),
- refinement (to handle relationships between levels of abstraction),
- interfaces and components, and
- a constraint language.

Many of these ideas were present in various individual methods and theories but UML brings them together into a coherent whole. In addition to these major changes, there are many other localized improvements over the Booch, OMT, and OOSE semantics and notation.

The UML is an evolution from Booch, OMT, OOSE, other object-oriented methods, and many other sources. These various sources incorporated many different elements from many authors, including non-OO influences. The UML notation is a melding of graphical syntax from various sources, with a number of symbols removed (because they were confusing, superfluous, or little used) and with a few new symbols added. The ideas in the UML come from the community of

1.6 UML - Past, Present, and Future

ideas developed by many different people in the object-oriented field. The UML developers did not invent most of these ideas; rather, their role was to select and integrate the best ideas from object modeling and computer-science practices. The actual genealogy of the notation and underlying detailed semantics is complicated, so it is discussed here only to provide context, not to represent precise history.

Use-case diagrams are similar in appearance to those in OOSE.

Class diagrams are a melding of OMT, Booch, class diagrams of most other object methods. Stereotypes and their corresponding icons can be defined for various diagrams to support other modeling styles. Stereotypes, constraints, and taggedValues are concepts added in UML that did not previously exist in the major modeling languages.

Statechart diagrams are substantially based on the statecharts of David Harel with minor modifications. Activity graph diagrams, which share much of the same underlying semantics, are similar to the work flow diagrams developed by many sources including many pre-object sources.

Sequence diagrams were found in a variety of object methods under a variety of names (interaction, message trace, and event trace) and date to pre-object days. Collaboration diagrams were adapted from Booch (object diagram), Fusion (object interaction graph), and a number of other sources.

Collaborations are now first-class modeling entities, and often form the basis of patterns.

The implementation diagrams (component and deployment diagrams) are derived from Booch's module and process diagrams, but they are now component-centered, rather than module-centered and are far better interconnected.

Stereotypes are one of the extension mechanisms and extend the semantics of the metamodel. User-defined icons can be associated with given stereotypes for tailoring the UML to specific processes.

Object Constraint Language is used by UML to specify the semantics and is provided as a language for expressions during modeling. OCL is an expression language having its root in the Syntropy method and has been influenced by expression languages in other methods like Catalysis. The informal navigation from OMT has the same intent, where OCL is formalized and more extensive.

Each of these concepts has further predecessors and many other influences. We realize that any brief list of influences is incomplete and we recognize that the UML is the product of a long history of ideas in the computer science and software engineering area.

1.6 UML - Past, Present, and Future

The UML was developed by Rational Software and its partners. Many companies are incorporating the UML as a standard into their development process and products, which cover disciplines such as business modeling, requirements management, analysis & design, programming, and testing.

1 UML Summary

1.6.1 UML 0.8 - 0.91

Precursors to UML

Identifiable object-oriented modeling languages began to appear between mid-1970 and the late 1980s as various methodologists experimented with different approaches to object-oriented analysis and design. Several other techniques influenced these languages, including Entity-Relationship modeling, the Specification & Description Language (SDL, circa 1976, CCITT), and other techniques. The number of identified modeling languages increased from less than 10 to more than 50 during the period between 1989-1994. Many users of object methods had trouble finding complete satisfaction in any one modeling language, fueling the “method wars.” By the mid-1990s, new iterations of these methods began to appear, most notably Booch’93, the continued evolution of OMT, and Fusion. These methods began to incorporate each other’s techniques, and a few clearly prominent methods emerged, including the OOSE, OMT-2, and Booch’93 methods. Each of these was a complete method, and was recognized as having certain strengths. In simple terms, OOSE was a use-case oriented approach that provided excellent support business engineering and requirements analysis. OMT-2 was especially expressive for analysis and data-intensive information systems. Booch’93 was particularly expressive during design and construction phases of projects and popular for engineering-intensive applications.

Booch, Rumbaugh, and Jacobson Join Forces

The development of UML began in October of 1994 when Grady Booch and Jim Rumbaugh of Rational Software Corporation began their work on unifying the Booch and OMT (Object Modeling Technique) methods. Given that the Booch and OMT methods were already independently growing together and were collectively recognized as leading object-oriented methods worldwide, Booch and Rumbaugh joined forces to forge a complete unification of their work. A draft version 0.8 of the Unified Method, as it was then called, was released in October of 1995. In the Fall of 1995, Ivar Jacobson and his Objectory company joined Rational and this unification effort, merging in the OOSE (Object-Oriented Software Engineering) method. The Objectory name is now used within Rational primarily to describe its UML-compliant process, the Rational Unified Process.

As the primary authors of the Booch, OMT, and OOSE methods, Grady Booch, Jim Rumbaugh, and Ivar Jacobson were motivated to create a unified modeling language for three reasons. First, these methods were already evolving toward each other independently. It made sense to continue that evolution together rather than apart, eliminating the potential for any unnecessary and gratuitous differences that would further confuse users. Second, by unifying the semantics and notation, they could bring some stability to the object-oriented marketplace, allowing projects to settle on one mature modeling language and letting tool builders focus on delivering more useful features. Third, they expected that their collaboration would yield improvements in all three earlier methods, helping them to capture lessons learned and to address problems that none of their methods previously handled well.

As they began their unification, they established four goals to focus their efforts:

1. Enable the modeling of systems (and not just software) using object-oriented concepts
2. Establish an explicit coupling to conceptual as well as executable artifacts

1.6 UML - Past, Present, and Future

3. Address the issues of scale inherent in complex, mission-critical systems
4. Create a modeling language usable by both humans and machines

Devising a notation for use in object-oriented analysis and design is not unlike designing a programming language. There are tradeoffs. First, one must bound the problem: Should the notation encompass requirement specification? (Yes, partially.) Should the notation extend to the level of a visual programming language? (No.) Second, one must strike a balance between expressiveness and simplicity: Too simple a notation will limit the breadth of problems that can be solved; too complex a notation will overwhelm the mortal developer. In the case of unifying existing methods, one must also be sensitive to the installed base: Make too many changes, and you will confuse existing users. Resist advancing the notation, and you will miss the opportunity of engaging a much broader set of users. The UML definition strives to make the best tradeoffs in each of these areas.

The efforts of Booch, Rumbaugh, and Jacobson resulted in the release of the UML 0.9 and 0.91 documents in June and October of 1996. During 1996, the UML authors invited and received feedback from the general community. They incorporated this feedback, but it was clear that additional focused attention was still required.

1.6.2 UML Partners

During 1996, it became clear that several organizations saw UML as strategic to their business. A Request for Proposal (RFP) issued by the Object Management Group (OMG) provided the catalyst for these organizations to join forces around producing a joint RFP response. Rational established the UML Partners consortium with several organizations willing to dedicate resources to work toward a strong UML definition. Those contributing most to the UML definition included: Digital Equipment Corp., HP, i-Logix, IntelliCorp, IBM, ICON Computing, MCI Systemhouse, Microsoft, Oracle, Rational Software, TI, and Unisys. This collaboration produced UML, a modeling language that was well defined, expressive, powerful, and generally applicable.

In January 1997 IBM & ObjecTime; Platinum Technology; Ptech; Taskon & Reich Technologies; and Softeam also submitted separate RFP responses to the OMG. These companies joined the UML partners to contribute their ideas, and together the partners produced the revised UML 1.1 response. The focus of the UML 1.1 release was to improve the clarity of the UML 1.0 semantics and to incorporate contributions from the new partners.

This document is based on the UML 1.1 release and is the result of a collaborative team effort. The UML Partners have worked hard as a team to define UML. While each partner came in with their own perspective and areas of interest, the result has benefited from each of them and from the diversity of their experiences. The UML Partners contributed a variety of expert perspectives, including, but not limited to, the following: OMG and RM-ODP technology perspectives, business modeling, constraint language, state machine semantics, types, interfaces, components, collaborations, refinement, frameworks, distribution, and metamodel.

1 UML Summary

1.6.3 UML - Present and Future

The UML is nonproprietary and open to all. It addresses the needs of user and scientific communities, as established by experience with the underlying methods on which it is based. Many methodologists, organizations, and tool vendors have committed to use it. Since the UML builds upon similar semantics and notation from Booch, OMT, OOSE, and other leading methods and has incorporated input from the UML partners and feedback from the general public, widespread adoption of the UML should be straightforward.

There are two aspects of "unified" that the UML achieves: First, it effectively ends many of the differences, often inconsequential, between the modeling languages of previous methods. Secondly, and perhaps more importantly, it unifies the perspectives among many different kinds of systems (business versus software), development phases (requirements analysis, design, and implementation), and internal concepts.

Standardization of the UML

Many organizations have already endorsed the UML as their organization's standard, since it is based on the modeling languages of leading object methods. The UML is ready for widespread use. This document is suitable as the primary source for authors writing books and training materials, as well as developers implementing visual modeling tools. Additional collateral, such as articles, training courses, examples, and books, will soon make the UML very approachable for a wide audience.

The Unified Modeling Language v. 1.1 specification which was added to the list of OMG Adopted Technologies in November 1997. Since then the OMG has assumed responsibility for the further development of the UML standard.

Revision of the UML

After adoption of the UML 1.1 proposal by the OMG membership in November 1997, the OMG chartered a revision task force (RTF) to accept comments from the general public and to make revisions to the specifications to handle bugs, inconsistencies, ambiguities, and minor omissions that could be handled without a major change in scope from the original proposal. The members of the RTF were drawn from the original proposers with a few additional persons. The RTF issued several preliminary reports with the final report containing UML 1.3 due for the second quarter of 1999. It contains a number of changes to the UML metamodel, semantics, and notation, but in the big picture this version should be considered a minor upgrade to the original proposal. More substantive changes and expansion in scope would require the full OMG proposal and adoption process.

Industrialization

Many organizations and vendors worldwide have already embraced the UML. The number of endorsing organizations is expected to grow significantly over time. These organizations will continue to encourage the use of the Unified Modeling Language by making the definition readily available and by encouraging other methodologists, tool vendors, training organizations, and authors to adopt the UML.

1.6 UML - Past, Present, and Future

The real measure of the UML's success is its use on successful projects and the increasing demand for supporting tools, books, training, and mentoring.

Future UML Evolution

Although the UML defines a precise language, it is not a barrier to future improvements in modeling concepts. We have addressed many leading-edge techniques, but expect additional techniques to influence future versions of the UML. Many advanced techniques can be defined using UML as a base. The UML can be extended without redefining the UML core.

The UML, in its current form, is expected to be the basis for many tools, including those for visual modeling, simulation, and development environments. As interesting tool integrations are developed, implementation standards based on the UML will become increasingly available.

The UML has integrated many disparate ideas, so this integration will accelerate the use of object-orientation. Component-based development is an approach worth mentioning. It is synergistic with traditional object-oriented techniques. While reuse based on components is becoming increasingly widespread, this does not mean that component-based techniques will replace object-oriented techniques. There are only subtle differences between the semantics of components and classes.

1 UML Summary

The UML Semantics section is primarily intended as a comprehensive and precise specification of the UML's semantic constructs.

Contents

Part 1 - Background	2-3
2.1 Introduction	2-3
2.2 Language Architecture	2-4
2.3 Language Formalism	2-8
Part 2 - Foundation	2-13
2.4 Foundation Package	2-13
2.5 Core	2-13
2.6 Extension Mechanisms	2-65
2.7 Data Types	2-75
Part 3 - Behavioral Elements	2-83
2.8 Behavioral Elements Package	2-83
2.9 Common Behavior	2-83
2.10 Collaborations	2-103
2.11 Use Cases	2-116
2.12 State Machines	2-127
2.13 Activity Graphs	2-157
Part 4 - General Mechanisms	2-169
2.14 Model Management	2-169
Index	2-183

2 UML Semantics

Part 1 - Background

2.1 Introduction

2.1.1 Purpose and Scope

The primary audience for this detailed description consists of the OMG, other standards organizations, tool builders, metamodelers, methodologists, and expert modelers. The authors assume familiarity with metamodeling and advanced object modeling. Readers looking for an introduction to the UML or object modeling should consider another source.

Although the document is meant for advanced readers, it is also meant to be easily understood by its intended audience. Consequently, it is structured and written to increase readability. The structure of the document, like the language, builds on previous concepts to refine and extend the semantics. In addition, the document is written in a ‘semi-formal’ style that combines natural and formal languages in a complementary manner.

This section specifies semantics for structural and behavioral object models. Structural models (also known as static models) emphasize the structure of objects in a system, including their classes, interfaces, attributes and relations. Behavioral models (also known as dynamic models) emphasize the behavior of objects in a system, including their methods, interactions, collaborations, and state histories.

This section provides complete semantics for all modeling notations described in the UML Notation Guide (Chapter 3). This includes support for a wide range of diagram techniques: class diagram, object diagram, use case diagram, sequence diagram, collaboration diagram, state diagram, activity diagram, and deployment diagram. The UML Notation Guide includes a summary of the semantics sections that are relevant to each diagram technique.

2.1.2 Approach

This section emphasizes language architecture and formal rigor. The architecture of the UML is based on a four-layer metamodel structure, which consists of the following layers: user objects, model, metamodel, and meta-metamodel. This document is primarily concerned with the metamodel layer, which is an instance of the meta-metamodel layer. For example, Class in the metamodel is an instance of MetaClass in the meta-metamodel. The metamodel architecture of UML is discussed further in “Language Architecture” on page 2-4.

The UML metamodel is a logical model and not a physical (or implementation) model. The advantage of a logical metamodel is that it emphasizes declarative semantics, and suppresses implementation details. Implementations that use the logical metamodel must conform to its semantics, and must be able to import and export full as well as partial models. However, tool vendors may construct the logical metamodel in various ways, so they can tune their implementations for reliability and performance. The disadvantage of a logical model is that it lacks the imperative semantics required for accurate and efficient implementation. Consequently, the metamodel is accompanied with implementation notes for tool builders.

2 UML Semantics

UML is also structured within the metamodel layer. The language is decomposed into several logical packages: Foundation, Behavioral Elements, and Model Management. These packages in turn are decomposed into subpackages. For example, the Foundation package consists of the Core, Extension Mechanisms, and Data Types subpackages. The structure of the language is fully described in “Language Architecture” on page 2-4.

The metamodel is described in a semi-formal manner using these views:

- Abstract syntax
- Well-formedness rules
- Semantics

The abstract syntax is provided as a model described in a subset of UML, consisting of a UML class diagram and a supporting natural language description. (In this way the UML bootstraps itself in a manner similar to how a compiler is used to compile itself.) The well-formedness rules are provided using a formal language (Object Constraint Language) and natural language (English). Finally, the semantics are described primarily in natural language, but may include some additional notation, depending on the part of the model being described. The adaptation of formal techniques to specify the language is fully described in “Language Formalism” on page 2-8.

In summary, the UML metamodel is described in a combination of graphic notation, natural language and formal language. We recognize that there are theoretical limits to what one can express about a metamodel using the metamodel itself. However, our experience suggests that this combination strikes a reasonable balance between expressiveness and readability.

2.2 Language Architecture

2.2.1 Four-Layer Metamodel Architecture

The UML metamodel is defined as one of the layers of a four-layer metamodeling architecture. This architecture is a proven infrastructure for defining the precise semantics required by complex models. There are several other advantages associated with this approach:

- It refines semantic constructs by recursively applying them to successive metalayers.
- It provides an architectural basis for defining future UML metamodel extensions.
- It furnishes an architectural basis for aligning the UML metamodel with other standards based on a four-layer metamodeling architecture, in particular the OMG Meta-Object Facility (MOF).

The generally accepted framework for metamodeling is based on an architecture with four layers:

- meta-metamodel
- metamodel
- model
- user objects

2.2 Language Architecture

The functions of these layers are summarized in the following table.

Table 2-1 Four Layer Metamodeling Architecture

Layer	Description	Example
meta-metamodel	The infrastructure for a metamodeling architecture. Defines the language for specifying metamodels.	<i>MetaClass, MetaAttribute, MetaOperation</i>
metamodel	An instance of a meta-metamodel. Defines the language for specifying a model.	<i>Class, Attribute, Operation, Component</i>
model	An instance of a metamodel. Defines a language to describe an information domain.	<i>StockShare, askPrice, sellLimitOrder, StockQuoteServer</i>
user objects (user data)	An instance of a model. Defines a specific information domain.	<i><Acme_SW_Share_98789>, 654.56, sell_limit_order, <Stock_Quote_Svr_32123></i>

The meta-metamodeling layer forms the foundation for the metamodeling architecture. The primary responsibility of this layer is to define the language for specifying a metamodel. A meta-metamodel defines a model at a higher level of abstraction than a metamodel, and is typically more compact than the metamodel that it describes. A meta-metamodel can define multiple metamodels, and there can be multiple meta-metamodels associated with each metamodel.

While it is generally desirable that related metamodels and meta-metamodels share common design philosophies and constructs, this is not a strict rule. Each layer needs to maintain its own design integrity. Examples of meta-metaobjects in the meta-metamodeling layer are: *MetaClass*, *MetaAttribute*, and *MetaOperation*.

A metamodel is an instance of a meta-metamodel. The primary responsibility of the metamodel layer is to define a language for specifying models. Metamodels are typically more elaborate than the meta-metamodels that describe them, especially when they define dynamic semantics. Examples of metaobjects in the metamodeling layer are: *Class*, *Attribute*, *Operation*, and *Component*.

A model is an instance of a metamodel. The primary responsibility of the model layer is to define a language that describes an information domain. Examples of objects in the modeling layer are: *StockShare*, *askPrice*, *sellLimitOrder*, and *StockQuoteServer*.

User objects (a.k.a. user data) are an instance of a model. The primary responsibility of the user objects layer is to describe a specific information domain. Examples of objects in the user objects layer are: *<Acme_Software_Share_98789>*, *654.56*, *sell_limit_order*, and *<Stock_Quote_Svr_32123>*.

2 UML Semantics

Architectural Alignment with the MOF Meta-Metamodel

Both the UML and the MOF are based on a four-layer metamodel architecture, where the MOF meta-metamodel is the meta-metamodel for the UML metamodel. Since the MOF and UML have different scopes and differ in their abstraction levels (the UML metamodel tends to be more of a logical model than the MOF meta-metamodel), they are related by loose metamodeling rather than strict metamodeling.¹ As a result, the UML metamodel is an instance of the MOF meta-metamodel.

Consequently, there is not a strict isomorphic instance-of mapping between all the MOF meta-metamodel elements and the UML metamodel elements. In spite of this, since the two models were designed to be interoperable, the UML Core package metamodel and the MOF meta-metamodel are structurally quite similar.

2.2.2 Package Structure

The complexity of the UML metamodel is managed by organizing it into logical packages. These packages group metaclasses that show strong cohesion with each other and loose coupling with metaclasses in other packages. The metamodel is decomposed into the top-level packages shown in Figure 2-1 on page -6.

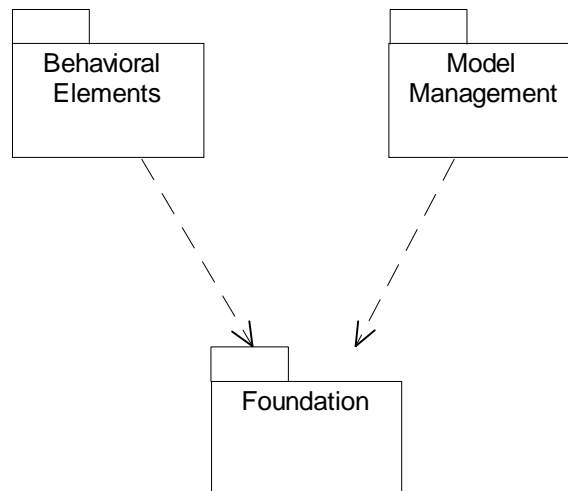

Figure 2-1 Top-Level Packages

The Foundation and Behavioral Elements packages are further decomposed as shown in Figure 2-2 and Figure 2-3 on page -7.

1. In loose (or “non-strict”) metamodeling a M_n level model is an instance of a M_{n+1} level model. In strict metamodeling, every element of a M_n level model is an instance of exactly one element of M_{n+1} level model.

2.2 Language Architecture

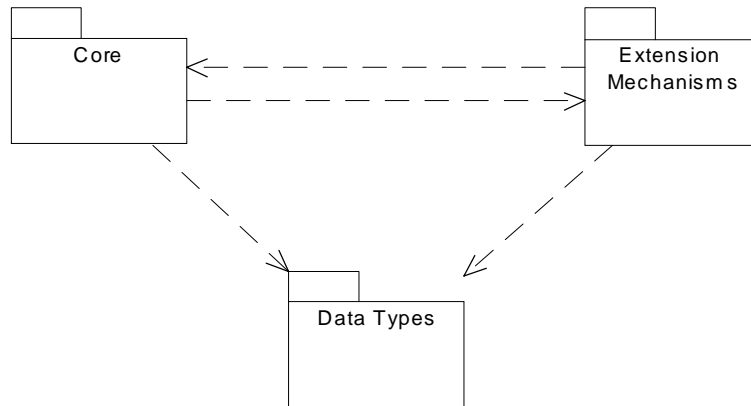

Figure 2-2 Foundation Packages

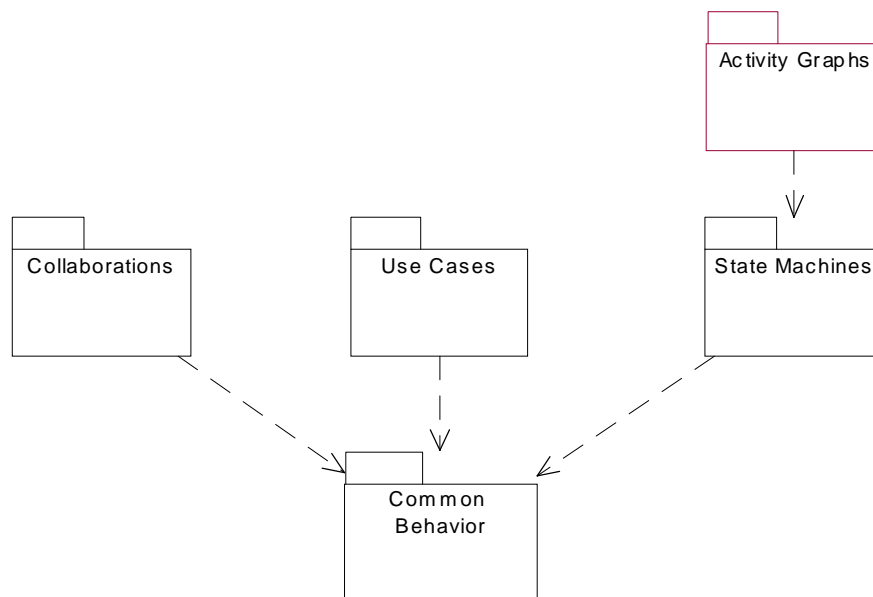

Figure 2-3 Behavioral Elements Packages

The functions and contents of these packages are described in this chapter's Part 3, Behavioral Elements.

2 UML Semantics

2.3 Language Formalism

This section contains a description of the techniques used to describe UML. The specification adapts formal techniques to improve precision while maintaining readability. The technique describes the UML metamodel in three views using both text and graphic presentations. The benefits of adapting formal techniques include:

- the correctness of the description is improved,
- ambiguities and inconsistencies are reduced,
- the architecture of the metamodel is validated by a complementary technique, and
- the readability of the description is increased.

It is important to note that the current description is not a completely formal specification of the language because to do so would have added significant complexity without clear benefit. In addition, the state of the practice in formal specifications does not yet address some of the more difficult language issues that UML introduces.

The structure of the language is nevertheless given a precise specification, which is required for tool interoperability. The dynamic semantics are described using natural language, although in a precise way so they can easily be understood. Currently, the dynamic semantics are not considered essential for the development of tools; however, this will probably change in the future.

2.3.1 Levels of Formalism

A common technique for specification of languages is to first define the syntax of the language and then to describe its static and dynamic semantics. The syntax defines what constructs exist in the language and how the constructs are built up in terms of other constructs. Sometimes, especially if the language has a graphic syntax, it is important to define the syntax in a notation independent way (i.e., to define the abstract syntax of the language). The concrete syntax is then defined by mapping the notation onto the abstract syntax. The syntax is described in the Abstract Syntax sections.

The static semantics of a language define how an instance of a construct should be connected to other instances to be meaningful, and the dynamic semantics define the meaning of a well-formed construct. The meaning of a description written in the language is defined only if the description is well formed (i.e., if it fulfills the rules defined in the static semantics). The static semantics are found in sections headed Well-Formedness Rules. The dynamic semantics are described under the heading Semantics. In some cases, parts of the static semantics are also explained in the Semantics section for completeness.

The specification uses a combination of languages - a subset of UML, an object constraint language, and precise natural language to describe the abstract syntax and semantics of the full UML. The description is self-contained; no other sources of information are needed to read the document². Although this is a metacircular description³, understanding this document is practical since only a small subset of UML constructs are needed to describe its semantics.

In constructing the UML metamodel different techniques have been used to specify language constructs, using some of the capabilities of UML. The main language constructs are reified into metaclasses in the metamodel. Other constructs, in essence being variants of other ones, are defined as stereotypes of metaclasses in the metamodel. This mechanism allows the semantics of the variant construct to be significantly different from the base metaclass. Another more "lightweight" way of defining variants is to use metaattributes. As an example, the aggregation construct is specified by an attribute of the metaclass `AssociationEnd`, which is used to indicate if an association is an ordinary aggregate, a composite aggregate, or a common association.

2.3.2 Package Specification Structure

This section provides information for each package in the UML metamodel. Each package has one or more of the following subsections.

Abstract Syntax

The abstract syntax is presented in a UML class diagram showing the metaclasses defining the constructs and their relationships. The diagram also presents some of the well-formedness rules, mainly the multiplicity requirements of the relationships, and whether or not the instances of a particular sub-construct must be ordered. Finally, a short informal description in natural language describing each construct is supplied. The first paragraph of each of these descriptions is a general presentation of the construct which sets the context, while the following paragraphs give the informal definition of the metaclass specifying the construct in UML. For each metaclass, its attributes are enumerated together with a short explanation. Furthermore, the opposite role names of associations connected to the metaclass are also listed in the same way.

Well-Formedness Rules

The static semantics of UML metaclasses, except for multiplicity and ordering constraints, are defined as a set of invariants of an instance of the metaclass. (Note that a metaclass is not required to have any invariants.) These invariants have to be satisfied for the construct to be meaningful. The rules thus specify constraints over attributes and associations defined in the metamodel. Each invariant is defined by an OCL expression together with an informal explanation of the expression. In many cases, additional operations on the metaclasses are needed for the OCL expressions. These are then defined in a separate subsection after the well-formedness rules for the construct, using the same approach as the abstract syntax: an informal explanation followed by the OCL expression defining the operation.

The statement 'No extra well-formedness rules' means that all current static semantics are expressed in the superclasses together with the multiplicity and type information expressed in the diagrams.

-
2. Although a comprehension of the UML's four-layer metamodel architecture and its underlying meta-metamodel is helpful, it is not essential to understand the UML semantics.
 3. In order to understand the description of the UML semantics, you must understand some UML semantics.

2 UML Semantics

Semantics

The meanings of the constructs are defined using natural language. The constructs are grouped into logical chunks that are defined together. Since only concrete metaclasses have a true meaning in the language, only these are described in this section.

Standard Elements

Stereotypes of the metaclasses defined previously in the section are listed, with an informal definition in natural language. Well-formedness rules, if any, for the stereotypes are also defined in the same manner as in the Well-Formedness Rules subsection.

Other kinds of standard elements (constraints and tagged-values) are listed, and are defined in the Standard Elements appendix.

Notes

This subsection may contain rationales for metamodeling decisions, pragmatics for the use of the constructs, and examples, all written in natural language.

2.3.3 *Use of a Constraint Language*

The specification uses the Object Constraint Language (OCL), as defined in Chapter 7, “Object Constraint Language Specification,” for expressing well-formedness rules. The following conventions are used to promote readability:

- Self - which can be omitted as a reference to the metaclass defining the context of the invariant, has been kept for clarity.
- In expressions where a collection is iterated, an iterator is used for clarity, even when formally unnecessary. The type of the iterator is usually omitted, but included when it adds to understanding.
- The ‘collect’ operation is left implicit where this is practical.

2.3.4 *Use of Natural Language*

We strove to be precise in our use of natural language, in this case English. For example, the description of UML semantics includes phrases such as “X provides the ability to...” and “X is a Y.” In each of these cases, the usual English meaning is assumed, although a deeply formal description would demand a specification of the semantics of even these simple phrases.

The following general rules apply:

- When referring to an instance of some metaclass, we often omit the word “instance.” For example, instead of saying “a Class instance” or “an Association instance,” we just say “a Class” or “an Association.” By prefixing it with an “a” or “an,” assume that we mean “an instance of.” In the same way, by saying something like “Elements” we mean “a set (or the set) of instances of the metaclass Element.”

- Every time a word coinciding with the name of some construct in UML is used, that construct is referenced.
- Terms including one of the prefixes sub, super, or meta are written as one word (e.g., metamodel, subclass).

2.3.5 Naming Conventions and Typography

In the description of UML, the following conventions have been used:

- When referring to constructs in UML, not their representation in the metamodel, normal text is used.
- Metaclass names that consist of appended nouns/adjectives, initial embedded capitals are used (e.g., 'ModelElement,' 'StructuralFeature').
- Names of metaassociations/association classes are written in the same manner as metaclasses (e.g., 'ElementReference').
- Initial embedded capital is used for names that consist of appended nouns/adjectives (e.g., 'ownedElement,' 'allContents').
- Boolean metaattribute names always start with 'is' (e.g., 'isAbstract').
- Enumeration types always end with "Kind" (e.g., 'AggregationKind').
- While referring to metaclasses, metaassociations, metaattributes, etc. in the text, the exact names as they appear in the model are always used.
- Names of stereotypes are delimited by guillemets and begin with lowercase (e.g., «type»).

2 UML Semantics

Part 2 - Foundation

2.4 Foundation Package

The Foundation package is the language infrastructure that specifies the static structure of models. The Foundation package is decomposed into the following subpackages: Core, Extension Mechanisms, and Data Types. Figure 2-4 illustrates the Foundation Packages. The Core package specifies the basic concepts required for an elementary metamodel and defines an architectural backbone for attaching additional language constructs, such as metaclasses, metaassociations, and metaattributes. The Extension Mechanisms package specifies how model elements are customized and extended with new semantics. The Data Types package defines basic data structures for the language.

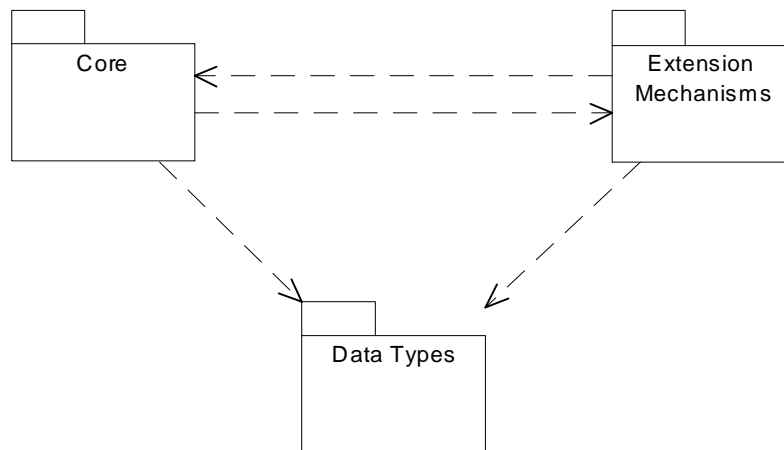

Figure 2-4 Foundation Packages

2.5 Core

2.5.1 Overview

The Core package is the most fundamental of the subpackages that compose the UML Foundation package. It defines the basic abstract and concrete metamodel constructs needed for the development of object models. Abstract constructs are not instantiable and are commonly used to reify key constructs, share structure, and organize the UML metamodel. Concrete metamodel constructs are instantiable and reflect the modeling constructs used by object modelers (cf. metamodelers). Abstract constructs defined in the Core include ModelElement, GeneralizableElement, and Classifier. Concrete constructs specified in the Core include Class, Attribute, Operation, and Association.

The Core package specifies the core constructs required for a basic metamodel and defines an architectural backbone (“skeleton”) for attaching additional language constructs such as metaclasses, metaassociations, and metaattributes. Although the Core package contains

2 UML Semantics

sufficient semantics to define the remainder of UML, it is not the UML meta-metamodel. It is the underlying base for the Foundation package, which in turn serves as the infrastructure for the rest of language. In other packages, the Core is extended by adding metaclasses to the backbone using generalizations and associations.

The following sections describe the abstract syntax, well-formedness rules, and semantics of the Core package.

2.5.2 Abstract Syntax

The abstract syntax for the Core package is expressed in graphic notation in the following figures. Figure 2-5 on page 2-14 shows the model elements that form the structural backbone of the metamodel. Figure 2-6 on page 2-15 shows the model elements that define relationships. Figure 2-7 on page 2-16 shows the model elements that define dependencies. Figure 2-8 on page 2-17 shows the various kinds of classifiers. Figure 2-9 on page 2-18 shows auxiliary elements for template parameters, presentation elements, and comments.

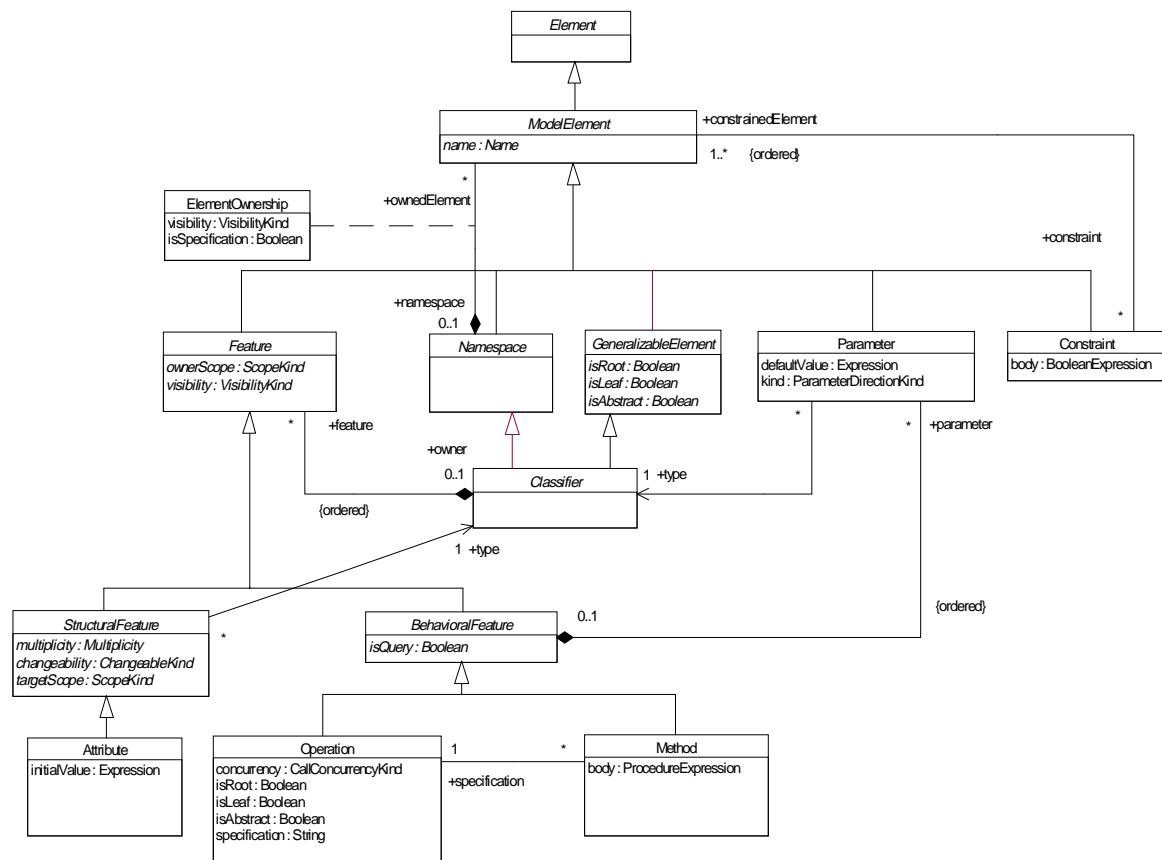

Figure 2-5 Core Package - Backbone

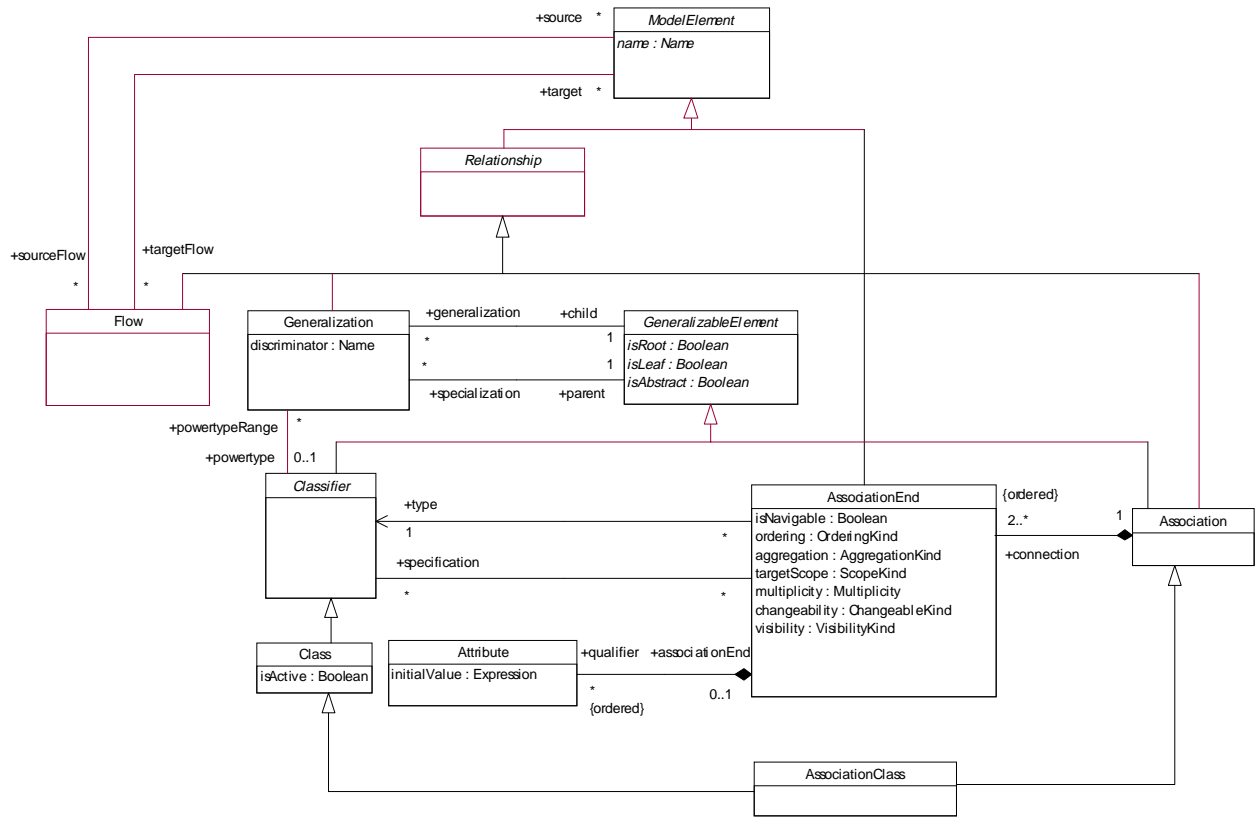

Figure 2-6 Core Package - Relationships

2 UML Semantics

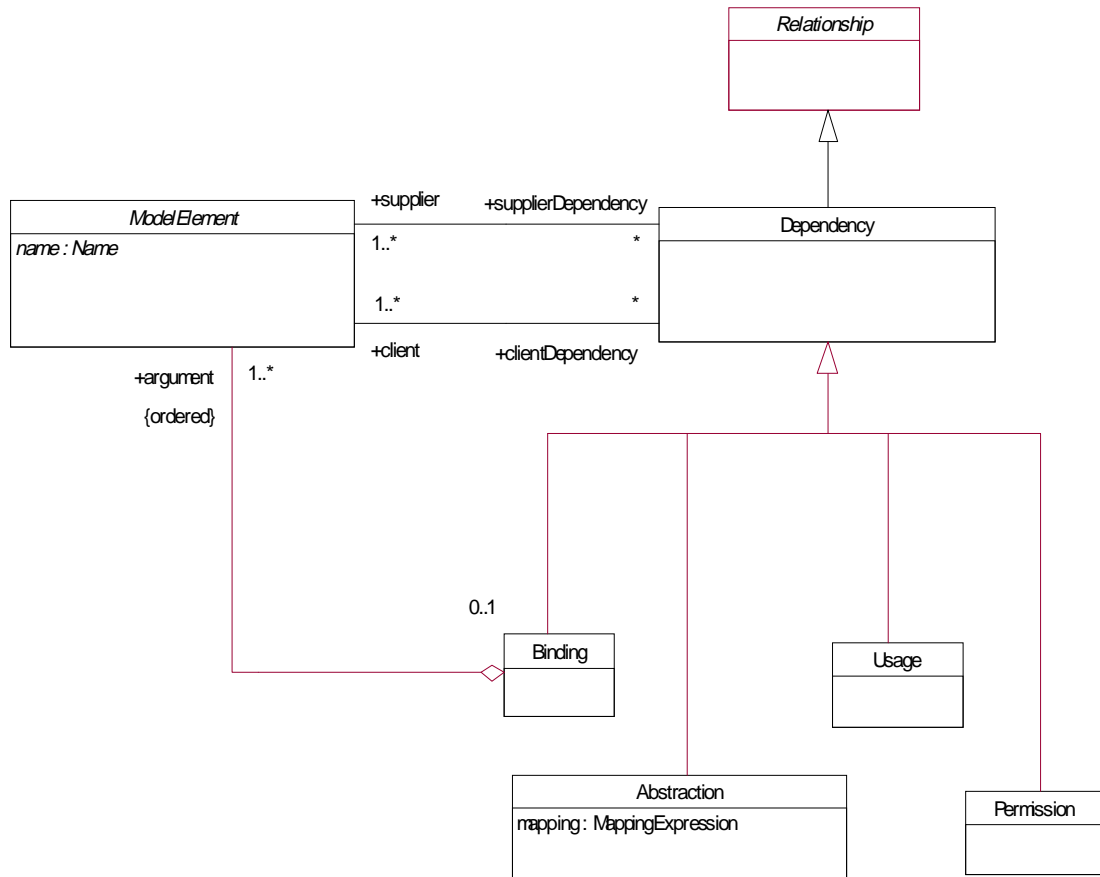

Figure 2-7 Core Package - Dependencies

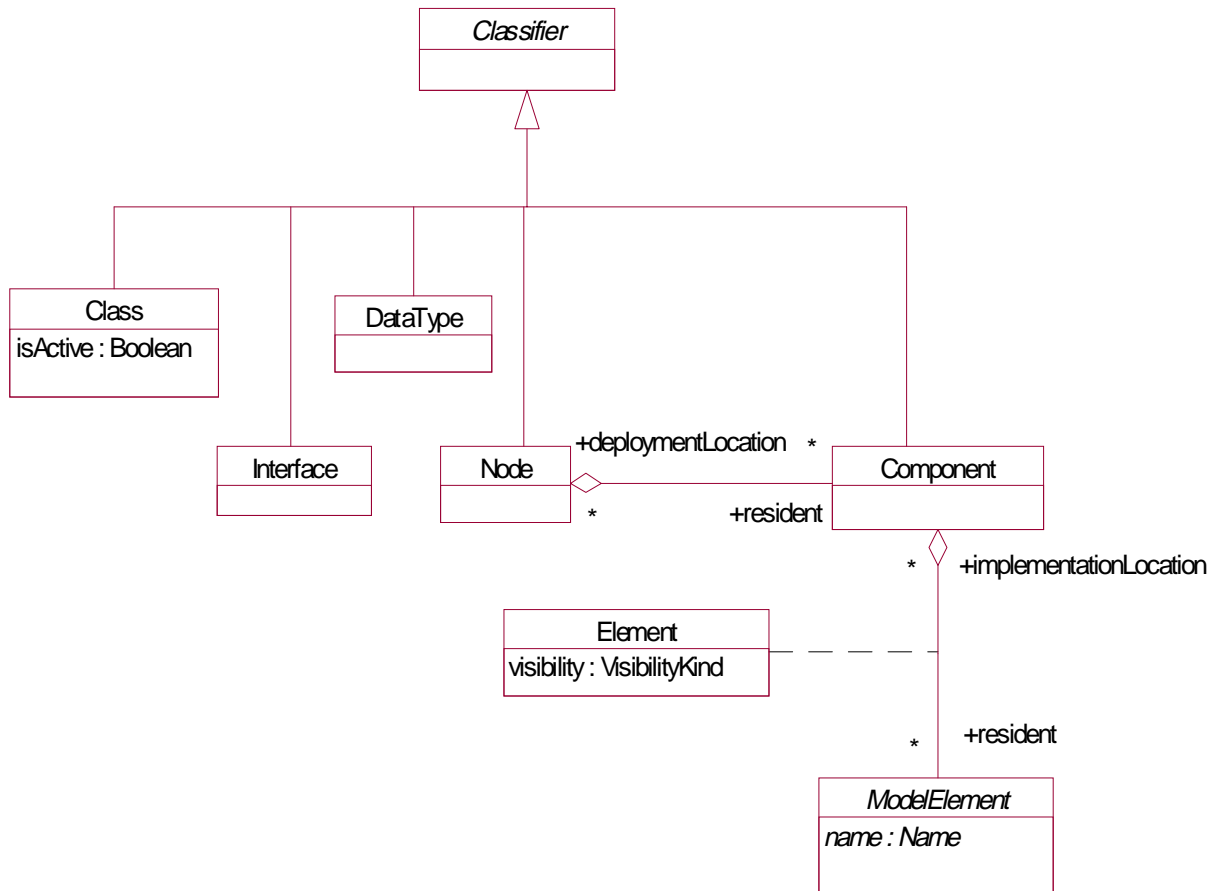

Figure 2-8 Core Package - Classifiers

2 UML Semantics

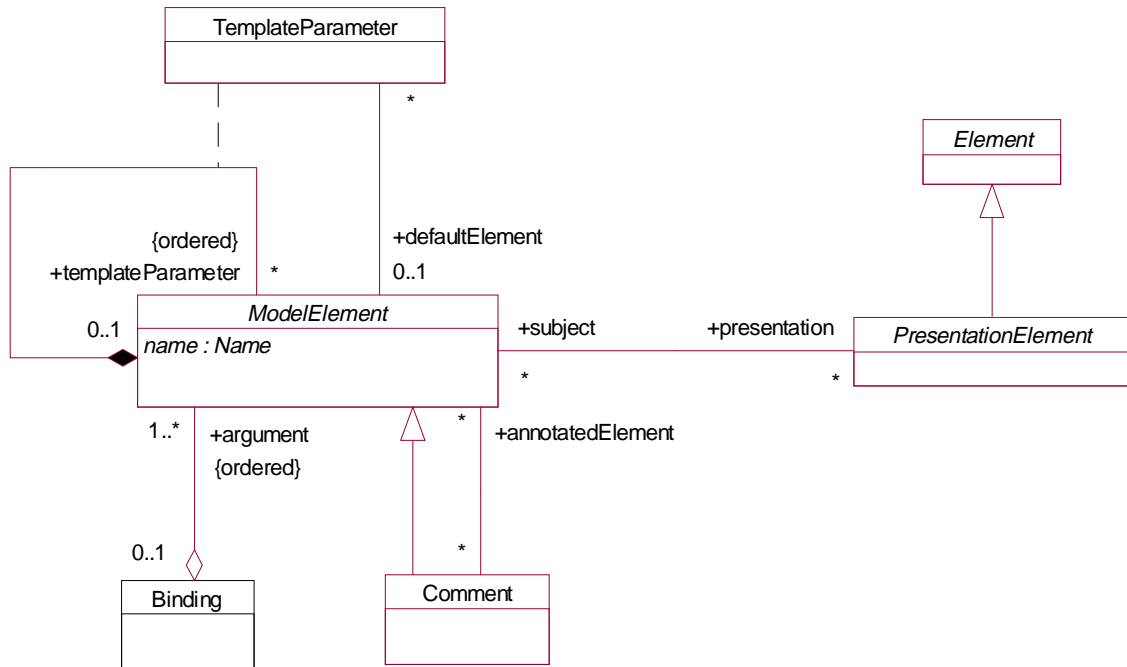

Figure 2-9 Core Package - Auxiliary elements

Abstraction

An abstraction is a Dependency relationship that relates two elements or sets of elements that represent the same concept at different levels of abstraction or from different viewpoints.

In the metamodel, an Abstraction is a Dependency in which there is a mapping between the supplier and the client. Depending on the specific stereotype of Abstraction, the mapping may be formal or informal, and it may be unidirectional or bidirectional.

If an Abstraction element has more than one client element, the supplier element maps into the set of client elements as a group. For example, an analysis-level class might be split into several design-level classes. The situation is similar if there is more than one supplier element.

The UML standard stereotyped classes of Abstraction are Derivation, Realization, Refinement, and Trace. (These are the names for the Abstraction class with the stereotypes «derive», «realize», «refine», and «trace», respectively.)

Attributes

mapping A MappingExpression that states the abstraction relationship between the supplier and the client. In some cases, such as Derivation, it is usually formal and unidirectional; in other cases, such as Trace, it is usually informal and bidirectional. The mapping attribute is optional and may be omitted if the precise relationship between the elements is not specified.

Stereotypes

«derive» (Name for the stereotyped class is Derivation.) Specifies a derivation relationship among model elements that are usually, but not necessarily, of the same type. A derived dependency specifies that the client may be computed from the supplier. The mapping specifies the computation. The client may be implemented for design reasons, such as efficiency, even though it is logically redundant.

«realize» (Name for the stereotyped class is Realization.) Specifies a realization relationship between a specification model element or elements (the supplier) and a model element or elements that implement it (the client). The implementation model element is required to support all of the operations or received signals that the specification model element declares. The implementation model element must make or inherit its own declarations of the operations and signal receptions. The mapping specifies the relationship between the two. The mapping may or may not be computable. Realization can be used to model stepwise refinement, optimizations, transformations, templates, model synthesis, framework composition, etc.

«refine» (Name for the stereotyped class is Refinement.) Specifies refinement relationship between model elements at different semantic levels, such as analysis and design. The mapping specifies the relationship between the two elements or sets of elements. The mapping may or may not be computable, and it may be unidirectional or bidirectional. Refinement can be used to model transformations from analysis to design and other such changes.

«trace» (Name for the stereotyped class is Trace.) Specifies a trace relationship between model elements or sets of model elements that represent the same concept in different models. Traces are mainly used for tracking requirements and changes across models. Since model changes can occur in both directions, the directionality of the dependency can often be ignored. The mapping specifies the relationship between the two, but it is rarely computable and is usually informal.

Association

An association defines a semantic relationship between classifiers. The instances of an association are a set of tuples relating instances of the classifiers. Each tuple value may appear at most once.

2 UML Semantics

In the metamodel, an Association is a declaration of a semantic relationship between Classifiers, such as Classes. An Association has at least two AssociationEnds. Each end is connected to a Classifier - the same Classifier may be connected to more than one AssociationEnd in the same Association. The Association represents a set of connections among instances of the Classifiers. An instance of an Association is a Link, which is a tuple of Instances drawn from the corresponding Classifiers.

Attributes

name The name of the Association which, in combination with its associated Classifiers, must be unique within the enclosing namespace (usually a Package).

Associations

connection An Association consists of at least two AssociationEnds, each of which represents a connection of the association to a Classifier. Each AssociationEnd specifies a set of properties that must be fulfilled for the relationship to be valid. The bulk of the structure of an Association is defined by its AssociationEnds.

Stereotypes

implicit The «implicit» stereotype is applied to an association, specifying that the association is not manifest, but rather is only conceptual.

Standard Constraints

xor The {xor} constraint is applied to a set of associations, specifying that over that set, exactly one is manifest for each associated instance. Xor is an exclusive or (not inclusive or) constraint.

Tagged Values

persistence Persistence denotes the permanence of the state of the association, marking it as transitory (its state is destroyed when the instance is destroyed) or persistent (its state is not destroyed when the instance is destroyed).

AssociationClass

An association class is an association that is also a class. It not only connects a set of classifiers but also defines a set of features that belong to the relationship itself and not any of the classifiers.

In the metamodel, an `AssociationClass` is a declaration of a semantic relationship between `Classifiers`, which has a set of features of its own. `AssociationClass` is a subclass of both `Association` and `Class` (i.e., each `AssociationClass` is both an `Association` and a `Class`); therefore, an `AssociationClass` has both `AssociationEnds` and `Features`.

AssociationEnd

An association end is an endpoint of an association, which connects the association to a classifier. Each association end is part of one association. The association-ends of each association are ordered.

In the metamodel, an `AssociationEnd` is part of an `Association` and specifies the connection of an `Association` to a `Classifier`. It has a name and defines a set of properties of the connection (e.g., which `Classifier` the `Instances` must conform to, their multiplicity, and if they may be reached from another `Instance` via this connection).

In the following descriptions when referring to an association end for a binary association, the source end is the other end. The target end is the one whose properties are being discussed.

Attributes

aggregation When placed on a target end, specifies whether the target end is an aggregation with respect to the source end. Only one end can be an aggregation. Possibilities are:

- none - The end is not an aggregate.
- aggregate - The end is an aggregate; therefore, the other end is a part and must have the aggregation value of none. The part may be contained in other aggregates.
- composite - The end is a composite; therefore, the other end is a part and must have the aggregation value of none. The part is strongly owned by the composite and may not be part of any other composite.

changeability When placed on a target end, specifies whether an instance of the `Association` may be modified from the source end. Possibilities are:

- changeable - No restrictions on modification.
- frozen - No links may be added after the creation of the source object.
- addOnly - Links may be added at any time from the source object, but once created a link may not be removed from the source end.

2 UML Semantics

<i>ordering</i>	<p>When placed on a target end, specifies whether the set of links from the source instance to the target instance is ordered. The ordering must be determined and maintained by Operations that add links. It represents additional information not inherent in the objects or links themselves. Possibilities are:</p> <ul style="list-style-type: none">• unordered - The links form a set with no inherent ordering.• ordered - A set of ordered links can be scanned in order.• Other possibilities (such as sorted) may be defined later by declaring additional keywords. As with user-defined stereotypes, this would be a private extension supported by particular editing tools.
<i>isNavigable</i>	<p>When placed on a target end, specifies whether traversal from a source instance to its associated target instances is possible. Specification of each direction across the Association is independent. A value of true means that the association can be navigated by the source class and the target rolename can be used in navigation expressions.</p>
<i>multiplicity</i>	<p>When placed on a target end, specifies the number of target instances that may be associated with a single source instance across the given Association.</p>
<i>name</i>	<p>(Inherited from ModelElement) The rolename of the end. When placed on a target end, provides a name for traversing from a source instance across the association to the target instance or set of target instances. It represents a pseudo-attribute of the source classifier (i.e., it may be used in the same way as an Attribute) and must be unique with respect to Attributes and other pseudo-attributes of the source Classifier.</p>
<i>targetScope</i>	<p>Specifies whether the target value is an instance or a classifier. Possibilities are:</p> <ul style="list-style-type: none">• instance. An instance value is part of each link. This is the default.• classifier. A classifier itself is part of each link. Normally this would be fixed at modeling time and need not be stored separately at run time.

<i>visibility</i>	Specifies the visibility of the association end from the viewpoint of the classifier on the other end. Possibilities are: <ul style="list-style-type: none"> • public - Other classifiers may navigate the association and use the rolename in expressions, similar to the use of a public attribute. • protected - Descendants of the source classifier may navigate the association and use the rolename in expressions, similar to the use of a protected attribute. • private - Only the source classifier may navigate the association and use the rolename in expressions, similar to the use of a private attribute.
-------------------	--

Associations

<i>qualifier</i>	An optional list of qualifier Attributes for the end. If the list is empty, then the Association is not qualified.
<i>specification</i>	Designates zero or more Classifiers that specify the Operations that may be applied to an Instance accessed by the AssociationEnd across the Association. These determine the minimum interface that must be realized by the actual Classifier attached to the end to support the intent of the Association. May be an Interface or another Classifier.
<i>type</i>	Designates the Classifier connected to the end of the Association. In a link, the actual class may be a descendant of the nominal class or (for an Interface) a Class that realizes the declared type.
<i>(unnamed composite end)</i>	Designates the Association that owns the AssociationEnd.

Stereotypes

«association»	Specifies a real association (default and redundant, but may be included for emphasis).
«global»	Specifies that the target is a global value that is known to all elements rather than an actual association.
«local»	Specifies that the relationship represents a local variable within a procedure rather than an actual association.
«parameter»	Specifies that the relationship represents a procedure parameter rather than an actual association.
«self»	Specifies that the relationship represents a reference to the object that owns an operation or action rather than an actual association.

Attribute

An attribute is a named slot within a classifier that describes a range of values that instances of the classifier may hold.

2 UML Semantics

In the metamodel, an Attribute is a named piece of the declared state of a Classifier, particularly the range of values that Instances of the Classifier may hold.

(The following list includes properties from StructuralFeature which has no other subclasses in the current metamodel.)

Attributes

<i>changeability</i>	Whether the value may be modified after the object is created. Possibilities are: <ul style="list-style-type: none">• changeable - No restrictions on modification.• frozen - The value may not be altered after the object is instantiated and its values initialized. No additional values may be added to a set.• addOnly - Meaningful only if the multiplicity is not fixed to a single value. Additional values may be added to the set of values, but once created a value may not be removed or altered.
<i>initialValue</i>	An Expression specifying the value of the attribute upon initialization. It is meant to be evaluated at the time the object is initialized. (Note that an explicit constructor may supersede an initial value.)
<i>multiplicity</i>	The possible number of data values for the attribute that may be held by an instance. The cardinality of the set of values is an implicit part of the attribute. In the common case in which the multiplicity is 1..1, then the attribute is a scalar (i.e., it holds exactly one value).
<i>targetScope</i>	Specifies whether the targets are ordinary Instances or are Classifiers. Possibilities are: <ul style="list-style-type: none">• instance - Each value contains a reference to an Instance of the target Classifier. This is the setting for a normal Attribute.• classifier - Each value contains a reference to the target Classifier itself. This represents a way to store meta-information.

Associations

<i>associationEnd</i>	Designates the optional AssociationEnd that owns the qualifier attribute. Note that an attribute may be part of an AssociationEnd (in which case it is a qualifier) or part of a Classifier (by inheritance from Feature, in which case it is a feature) but not both.
<i>type</i>	Designates the classifier whose instances are values of the attribute. Must be a Class, Interface, or DataType. The actual type may be a descendant of the declared type or (for an Interface) a Class that realizes the declared type.

Tagged Values

<i>persistence</i>	Persistence denotes the permanence of the state of the attribute, marking it as transitory (its state is destroyed when the instance is destroyed) or persistent (its state is not destroyed when the instance is destroyed).
--------------------	---

BehavioralFeature

A behavioral feature refers to a dynamic feature of a model element, such as an operation or method.

In the metamodel, a BehavioralFeature specifies a behavioral aspect of a Classifier. All different kinds of behavioral aspects of a Classifier, such as Operation and Method, are subclasses of BehavioralFeature. BehavioralFeature is an abstract metaclass.

Attributes

<i>isQuery</i>	Specifies whether an execution of the Feature leaves the state of the system unchanged. True indicates that the state is unchanged; false indicates that side-effects may occur.
<i>name</i>	(Inherited from ModelElement) The name of the Feature. The entire signature of the Feature (name and parameter list) must be unique within its containing Classifier.

Associations

<i>parameter</i>	An ordered list of Parameters for the Operation. To call the Operation, the caller must supply a list of values compatible with the types of the Parameters.
------------------	--

Stereotypes

«create»	Specifies that the designated feature creates an instance of the classifier to which the feature is attached. May be promoted to the Classifier containing the feature.
«destroy»	Specifies that the designated feature destroys an instance of the classifier to which the feature is attached. May be promoted to the classifier containing the feature.

Binding

A binding is a relationship between a template and a model element generated from the template. It includes a list of arguments matching the template parameters. The template is a form that is cloned and modified by substitution to yield an implicit model fragment that behaves as if it were a direct part of the model. A Binding must have one supplier and one client; unlike a general Dependency, the supplier and client may not be sets.

In the metamodel, a Binding is a Dependency where the supplier is the template and the client is the instantiation of the template that performs the substitution of parameters of a template. A Binding has a list of arguments that replace the parameters of the supplier to yield the client. The client is fully specified by the binding of the supplier's parameters and does not add any information of its own. An element may participate as a supplier in multiple Binding relationships to different clients. An element may participate in only one Binding relationship as a client.

Associations

<i>argument</i>	An ordered list of arguments. Each argument replaces the corresponding supplier parameter in the supplier definition, and the result represents the definition of the client as if it had been defined directly.
-----------------	--

Class

A class is a description of a set of objects that share the same attributes, operations, methods, relationships, and semantics. A class may use a set of interfaces to specify collections of operations it provides to its environment.

In the metamodel, a Class describes a set of Objects sharing a collection of Features, including Operations, Attributes and Methods, that are common to the set of Objects. Furthermore, a Class may realize zero or more Interfaces; this means that its full descriptor (see "Inheritance" on page 2-60 for the definition) must contain every Operation from every realized Interface (it may contain additional operations as well).

A Class defines the data structure of Objects, although some Classes may be abstract (i.e., no Objects can be created directly from them). Each Object instantiated from a Class contains its own set of values corresponding to the StructuralFeatures declared in the full descriptor. Objects do not contain values corresponding to BehavioralFeatures or class-scope Attributes; all Objects of a Class share the definitions of the BehavioralFeatures from the Class, and they all have access to the single value stored for each class-scope attribute.

Attributes

isActive Specifies whether an Object of the Class maintains its own thread of control. If true, then an Object has its own thread of control and runs concurrently with other active Objects. Such a class is informally called an *active class*. If false, then Operations run in the address space and under the control of the active Object that controls the caller. Such a class is informally called a *passive class*.

Stereotypes

«implementationClass» Specifies the implementation of a class in some programming language in which an instance may not have more than one class. This is in contrast to a general UML Class, for which an instance may have multiple classes at one time and may gain or lose classes over time, and an object (a child of instance) may dynamically have multiple classes.

«type» Specifies a domain of instances (objects) together with the operations applicable to the objects. A type may not contain any methods, but it may have attributes and associations.

Classifier

A classifier is an element that describes behavioral and structural features; it comes in several specific forms, including class, data type, interface, component, and others that are defined in other metamodel packages.

In the metamodel, a Classifier declares a collection of Features, such as Attributes, Methods, and Operations. It has a name, which is unique in the Namespace enclosing the Classifier. Classifier is an abstract metaclass.

Classifier is a child of GeneralizableElement and Namespace. As a GeneralizableElement, it may inherit Features and participation in Associations (in addition to things inherited as a ModelElement). It also inherits ownership of StateMachines, Collaborations, etc.

As a Namespace, a Classifier may declare other Classifiers nested in its scope. Nested Classifiers may be accessed by other Classifiers only if the nested Classifiers have adequate visibility. There are no data value or state consequences of nested Classifiers, i.e., it is not an aggregation or composition.

2 UML Semantics

Associations

<i>feature</i>	An ordered list of Features, like Attribute, Operation, Method, owned by the Classifier.
<i>participant</i>	Inverse of specification on association to AssociationEnd. Denotes that the Classifier participates in an Association.
<i>powertypeRange</i>	Designates zero or more Generalizations for which the Classifier is a powertype. If the cardinality is zero, then the Classifier is not a powertype; if the cardinality is greater than zero, then the Classifier is a powertype over the set of Generalizations designated by the association, and the child elements of the Generalizations are the instances of the Classifier as a powertype. A Classifier that is a powertype can be marked with the «powertype» stereotype.

Stereotypes

«metaclass»	Specifies that the instances of the classifier are classes.
«powertype»	Specifies that the classifier is a metatype, the instances of which are children marked by the same discriminator.
«process»	Specifies a classifier that represents a heavy-weight flow of control.
«thread»	Specifies a classifier that represents a flow of control.
«utility»	Specifies a classifier that has no instances, but rather denotes a named collection of non-member attributes and operations, all of which are class-scoped.

Tagged Values

<i>persistence</i>	Persistence denotes the permanence of the state of the classifier, marking it as transitory (its state is destroyed when the instance is destroyed) or persistent (its state is not destroyed when the instance is destroyed).
<i>semantics</i>	Semantics is the specification of the meaning of the classifier.

Comment

A comment is an annotation attached to a model element or a set of model elements. It has no semantic force but may contain information useful to the modeler.

Associations

<i>annotatedElement</i>	A ModelElement or set of ModelElements described by the Comment.
-------------------------	--

Stereotypes

«requirement»	Specifies a desired feature, property, or behavior of an element as part of a system.
«responsibility»	Specifies a contract or an obligation of an element in its relationship to other elements.

Component

A component is a physical, replaceable part of a system that packages implementation and provides the realization of a set of interfaces. A component represents a physical piece of implementation of a system, including software code (source, binary or executable) or equivalents such as scripts or command files. As such, a Component may itself conform to and provide the realization of a set of interfaces, which represent services implemented by the elements resident in the component. These services define behavior offered by instances of the Component as a whole to other client Component instances.

In the metamodel, a Component is a child of Classifier. It provides the physical packaging of its associated specification elements. As a Classifier, it may also have its own Features, such as Attributes and Operations, and realize Interfaces.

Associations

<i>deploymentLocation</i>	The set of Nodes the Component is residing on.
<i>resident</i>	(Association class ElementResidence) The set of model elements that the component supports. The visibility attribute shows the external visibility of the element outside the component.

Stereotypes

«document»	Denotes a document.
«executable»	Denotes a program that may be run on a node.
«file»	Denotes a document containing source code or data.
«library»	Denotes a static or dynamic library.
«table»	Denotes a data base table.

Constraint

A constraint is a semantic condition or restriction expressed in text.

2 UML Semantics

In the metamodel, a Constraint is a BooleanExpression on an associated ModelElement(s) which must be true for the model to be well formed. This restriction can be stated in natural language, or in different kinds of languages with a well-defined semantics. Certain Constraints are predefined in the UML, others may be user defined. Note that a Constraint is an assertion, not an executable mechanism. It indicates a restriction that must be enforced by correct design of a system.

Attributes

body A BooleanExpression that must be true when evaluated for an instance of a system to be well-formed.

Associations

constrainedElement A ModelElement or list of ModelElements affected by the Constraint. If the constrained element is a Stereotype, then the constraint applies to all ModelElements that use the stereotype.

Stereotypes

«invariant» Specifies a constraint that must be attached to a set of classifiers or relationships. It indicates that the conditions of the constraint must hold over time (for the time period of concern in the particular containing element) for the classifiers or relationships and their instances.

«postcondition» Specifies a constraint that must be attached to an operation, and denotes that the conditions of the constraint must hold after the invocation of the operation.

«precondition» Specifies a constraint that must be attached to an operation, and denotes that the conditions of the constraint must hold for the invocation of the operation.

Data Type

A data type is a type whose values have no identity (i.e., they are pure values). Data types include primitive built-in types (such as integer and string) as well as definable enumeration types (such as the predefined enumeration type boolean whose literals are false and true).

In the metamodel, a DataType defines a special kind of Classifier in which Operations are all pure functions (i.e., they can return DataValues but they cannot change DataValues, because they have no identity). For example, an “add” operation on a number with another number as an argument yields a third number as a result; the target and argument are unchanged.

Dependency

A term of convenience for a Relationship other than Association, Generalization, Flow, or metarelationship (such as the relationship between a Classifier and one of its Instances).

A dependency states that the implementation or functioning of one or more elements requires the presence of one or more other elements.

In the metamodel, a Dependency is a directed relationship from a client (or clients) to a supplier (or suppliers) stating that the client is dependent on the supplier (i.e., the client element requires the presence and knowledge of the supplier element).

The kinds of Dependency are Abstraction, Binding, Permission, and Usage. Various stereotypes of those elements are predefined.

Associations

<i>client</i>	The element that is affected by the supplier element. In some cases (such as a Trace Abstraction) the direction is unimportant and serves only to distinguish the two elements.
<i>supplier</i>	Inverse of client. Designates the element that is unaffected by a change. In a two-way relationship (such as some Refinement Abstractions) this would be the more general element. In an undirected situation, such as a Trace Abstraction, the choice of client and supplier may be irrelevant.

Element

An element is an atomic constituent of a model.

In the metamodel, an Element is the top metaclass in the metaclass hierarchy. It has two subclasses: ModelElement and PresentationElement. Element is an abstract metaclass.

Tagged Values

documentation	Documentation is a comment, description, or explanation of the element to which it is attached.
---------------	---

ElementOwnership

Element ownership defines the visibility of a ModelElement contained in a Namespace.

In the metamodel, ElementOwnership reifies the relationship between ModelElement and Namespace denoting the ownership of a ModelElement by a Namespace and its visibility outside the Namespace. See “ModelElement” on page 2-37.

2 UML Semantics

Attributes

<i>isSpecification</i>	Specifies whether the ownedElement is part of the specification for the containing namespace (in cases where specification is distinguished from the realization). Otherwise the ownedElement is part of the realization. In cases in which the distinction is not made, the value is false by default.
<i>visibility</i>	Specifies whether the ModelElement can be seen and referenced by other ModelElements. Possibilities: <ul style="list-style-type: none">• public - Any outside ModelElement can see the ModelElement.• protected - Any descendent of the ModelElement can see the ModelElement.• private - Only the ModelElement itself, its constituent parts, or elements nested within it can see the ModelElement. Note that use of an element in another Package may also be subject to access or import of its Package as described in Model Management; see Permission.

ElementResidence

Association class between Component and ModelElement. See Component::resident. Shows that the component supports the element.

Attributes

<i>visibility</i>	Specifies whether the ModelElement can be used by other Components. Possibilities: <ul style="list-style-type: none">• public - Any outside Component can use the ModelElement.• protected - Any descendent of the Component can use the ModelElement.• private - Only the Component itself can use the ModelElement.
-------------------	---

Feature

A feature is a property, like operation or attribute, which is encapsulated within a Classifier.

In the metamodel, a Feature declares a behavioral or structural characteristic of an Instance of a Classifier or of the Classifier itself. Feature is an abstract metaclass.

Attributes

<i>name</i>	(Inherited from ModelElement) The name used to identify the Feature within the Classifier or Instance. It must be unique across inheritance of names from ancestors including names of outgoing AssociationEnd. (See more specific rules for the exact details. Attributes, discriminators, and opposite association ends must have unique names in the set of inherited names. There may be multiple declarations of the same operation. Multiple operations may have the same name but different signatures; see the rules for precise details.)
<i>ownerScope</i>	<p>Specifies whether Feature appears in each Instance of the Classifier or whether there is just a single instance of the Feature for the entire Classifier. Possibilities are:</p> <ul style="list-style-type: none"> • instance - Each Instance of the Classifier holds its own value for the Feature. • classifier - There is just one value of the Feature for the entire Classifier.
<i>visibility</i>	<p>Specifies whether the Feature can be used by other Classifiers. Visibilities of nested Classifiers combine so that the most restrictive visibility is the result. Possibilities:</p> <ul style="list-style-type: none"> • public - Any outside Classifier with visibility to the Classifier can use the Feature. • protected - Any descendent of the Classifier can use the Feature. • private - Only the Classifier itself can use the Feature.

Associations

<i>owner</i>	The Classifier declaring the Feature. Note that an Attribute may be owned by a Classifier (in which case it is a feature) or an AssociationEnd (in which case it is a qualifier) but not both.
--------------	--

Flow

A flow is a relationship between two versions of an object or between an object and a copy of it.

In the metamodel, a Flow is a child of Relationship. A Flow is a directed relationship from a source or sources to a target or targets. It usually connects an activity to or from an object flow state, or two object flow states. It can also connect from a fork or to a branch.

2 UML Semantics

Predefined stereotypes of Flow are «become» and «copy». Become relates one version of an object to another with a different value, state, or location. Copy relates an object to another object that starts as a copy of it.

Stereotypes

«become»	Specifies a Flow relationship, source and target of which represent the same instance at different points in time, but each with potentially different values, state instance, and roles. A Become Dependency from A to B means that instance A becomes B with possibly new values, state instance, and roles at a different moment in time/space.
«copy»	Specifies a Flow relationship, the source and target of which are different instances, but each with the same values, state instance, and roles (but a distinct identity). A Copy Dependency from A to B means that B is an exact copy of A. Future changes in A are not necessarily reflected in B.

GeneralizableElement

A generalizable element is a model element that may participate in a generalization relationship.

In the metamodel, a GeneralizableElement can be a generalization of other GeneralizableElements (i.e., all Features defined in and all ModelElements contained in the ancestors are also present in the GeneralizableElement). GeneralizableElement is an abstract metaclass.

Attributes

<i>isAbstract</i>	Specifies whether the GeneralizableElement may not have a direct instance. True indicates that an instance of the GeneralizableElement must be an instance of a child of the GeneralizableElement. False indicates that there may be an instance of the GeneralizableElement that is not an instance of a child. An abstract GeneralizableElement is not instantiable since it does not contain all necessary information.
<i>isLeaf</i>	Specifies whether the GeneralizableElement is a GeneralizableElement with no descendants. True indicates that it may not have descendants, false indicates that it may have descendants (whether or not it actually has any descendants at the moment).
<i>isRoot</i>	Specifies whether the GeneralizableElement is a root GeneralizableElement with no ancestors. True indicates that it may not have ancestors, false indicates that it may have ancestors (whether or not it actually has any ancestors at the moment).

Associations

<i>generalization</i>	Designates a Generalization whose parent GeneralizableElement is the immediate ancestor of the current GeneralizableElement.
<i>specialization</i>	Designates a Generalization whose child GeneralizableElement is the immediate descendent of the current GeneralizableElement.

Generalization

A generalization is a taxonomic relationship between a more general element and a more specific element. The more specific element is fully consistent with the more general element (it has all of its properties, members, and relationships) and may contain additional information.

In the metamodel, a Generalization is a directed inheritance relationship, uniting a GeneralizableElement with a more general GeneralizableElement in a hierarchy. Generalization is a subtyping relationship (i.e., an Instance of the more general GeneralizableElement may be substituted by an Instance of the more specific GeneralizableElement). See Inheritance for the consequences of Generalization relationships.

Attributes

<i>discriminator</i>	Designates the partition to which the Generalization link belongs. All of the Generalization links that share a given parent GeneralizableElement are divided into disjoint sets (that is, partitions) by their discriminator names. Each partition (a set of links sharing a discriminator name) represents an orthogonal dimension of specialization of the parent GeneralizableElement. The discriminator need not be unique. The empty string is also considered as a partition name, therefore all Generalization links have a discriminator. If the set of Generalization links that have the same parent all have the same name, then the children in the Generalization links are GeneralizableElements that specialize the parent, and an instance of any of them is a legal instance of the parent. Otherwise an indirect instance of the parent must be a (direct or indirect) instance of at least one element from each of the partitions.
----------------------	---

Associations

<i>child</i>	Designates a GeneralizableElement that is the specialized version of the parent GeneralizableElement.
<i>parent</i>	Designates a GeneralizableElement that is the generalized version of the child GeneralizableElement.
<i>powertype</i>	Designates a Classifier that serves as a powertype for the child element along the dimension of generalization expressed by the Generalization. The child element is therefore an instance of the powertype element.

2 UML Semantics

Stereotypes

«implementation»	Specifies that the child inherits the implementation of the parent (its attributes, operations and methods) but does not make public the supplier's interfaces nor guarantee to support them, thereby violating substitutability. This is private inheritance and is usually used only for programming implementation purposes.
------------------	---

Standard Constraints

complete	Specifies a constraint applied to a set of generalizations with the same discriminator and the same parent, indicating that any instance of the parent must be an instance of at least one child within the set of generalizations. If a parent has a single discriminator, the set of its child generalizations being complete implies that the parent is abstract. The connotation of declaring a set of generalizations complete is that all of the children with the given discriminator have been declared and that additional ones are not expected (in other words, the set of generalizations is closed), and designs may assume with some confidence that the set of children is fixed. If a new child is nevertheless added in the future, existing models may be adversely affected and may require modification.
disjoint	Specifies a constraint applied to a set of generalizations, indicating that instance of the parent may be an instance of no more than one of the given children within the set of generalizations. This is the default semantics of generalization.
incomplete	Specifies a constraint applied to a set of generalizations with the same discriminator, indicating that an instance of the parent need not be an instance of a child within the set (but there is no guarantee that such an instance will actually exist). Being incomplete implies that the parent is concrete. The connotation of declaring a set of generalizations incomplete is that all of the children with the given discriminator have not necessarily been declared and that additional ones are might be added, therefore users should not count on the set of children being fixed.
overlapping	Specifies a constraint applied to a set of generalizations, indicating that an instance of one child may be simultaneously an instance of another child in the set (but there is no guarantee that such an instance will actually exist).

Interface

An interface is a named set of operations that characterize the behavior of an element.

In the metamodel, an Interface contains a set of Operations that together define a service offered by a Classifier realizing the Interface. A Classifier may offer several services, which means that it may realize several Interfaces, and several Classifiers may realize the same Interface.

Interfaces are GeneralizableElements.

Interfaces may not have Attributes, Associations, or Methods. An Interface may participate in an Association provided the Interface cannot see the Association; that is, a Classifier (other than an Interface) may have an Association to an Interface that is navigable from the Classifier but not from the Interface.

Method

A method is the implementation of an operation. It specifies the algorithm or procedure that effects the results of an operation.

In the metamodel, a Method is a declaration of a named piece of behavior in a Classifier and realizes one (directly) or a set (indirectly) of Operations of the Classifier.

Attributes

body The implementation of the Method as a ProcedureExpression.

Associations

specification Designates an Operation that the Method implements. The Operation must be owned by the Classifier that owns the Method or be inherited by it. The signatures of the Operation and Method must match.

ModelElement

A model element is an element that is an abstraction drawn from the system being modeled. Contrast with view element, which is an element whose purpose is to provide a presentation of information for human comprehension.

In the metamodel, a ModelElement is a named entity in a Model. It is the base for all modeling metaclasses in the UML. All other modeling metaclasses are either direct or indirect subclasses of ModelElement.

Each ModelElement can be regarded as a template. A template has a set of templateParameters that denotes which of the parts of a ModelElement are the template parameters. A ModelElement is a template when there is at least one template parameter. If it is not a template, a ModelElement cannot have template parameters. However, such embedded parameters are not usually complete and need not satisfy well-formedness rules. It is the arguments supplied when the template is instantiated that must be well-formed.

Partially instantiated templates are allowed. This is the case when there are arguments provided for some, but not all templateParameters. A partially instantiated template is still a template, since it still has parameters.

Attributes

name An identifier for the ModelElement within its containing Namespace.

2 UML Semantics

Associations

<i>clientDependency</i>	Inverse of client. Designates a set of Dependency in which the ModelElement is a client.
<i>constraint</i>	A set of Constraints affecting the element.
<i>implementationLocation</i>	The component that an implemented model element resides in.
<i>namespace</i>	Designates the Namespace that contains the ModelElement. Every ModelElement except a root element must belong to exactly one Namespace or else be a composite part of another ModelElement (which is a kind of virtual namespace). The pathname of Namespace or ModelElement names starting from the root package provides a unique designation for every ModelElement. The association attribute visibility specifies the visibility of the element outside its namespace (see ElementOwnership).
<i>presentation</i>	A set of PresentationElements that present a view of the ModelElement.
<i>supplierDependency</i>	Inverse of supplier. Designates a set of Dependency in which the ModelElement is a supplier.
<i>templateParameter</i>	(association class TemplateParameter) A composite aggregation ordered list of parameters. Each parameter is a dummy ModelElement designated as a placeholder for a real ModelElement to be substituted during a binding of the template (see Binding). The real model element must be of the same kind (or a descendant kind) as the dummy ModelElement. The properties of the dummy ModelElement are ignored, except the name of the dummy element is used as the name of the template parameter. The association class TemplateParameter may be associated with a default ModelElement of the same kind as the dummy ModelElement. In the case of a Binding that does not supply an argument corresponding to the parameter, the value of the default ModelElement is used. If a Binding lacks an argument and there is no default ModelElement, the construct is invalid. Note that the template parameter element lacks structure. For example, a parameter that is a Class lacks Features; they are found in the actual argument.

Note that iff a ModelElement has at least one templateParameter, then it is a template, otherwise it is an ordinary element.

Tagged Values

<i>derived</i>	A true value indicates that the model element can be completely derived from other model elements and is therefore logically redundant. In an analysis model, the element may be included to define a useful name or concept. In a design model, the usual intent is that the element should exist in the implementation to avoid the need for recomputation.
----------------	---

Namespace

A namespace is a part of a model that contains a set of ModelElements each of whose names designates a unique element within the namespace.

In the metamodel, a Namespace is a ModelElement that can own other ModelElements, like Associations and Classifiers. The name of each owned ModelElement must be unique within the Namespace. Moreover, each contained ModelElement is owned by at most one Namespace. The concrete subclasses of Namespace have additional constraints on which kind of elements may be contained. Namespace is an abstract metaclass.

Note that explicit parts of a model element, such as the features of a Classifier, are not modeled as owned elements in a namespace. A namespace is used for unstructured contents such as the contents of a package or a class declared inside the scope of another class.

Associations

ownedElement (association class ElementOwnership) A set of ModelElements owned by the Namespace. Its visibility attribute states whether the element is visible outside the namespace.

Node

A node is a run-time physical object that represents a computational resource, generally having at least a memory and often processing capability as well, and upon which components may be deployed.

In the metamodel, a Node is a subclass of Classifier. It is associated with a set of Components residing on the Node.

Associations

resident The set of Components residing on the Node.

Operation

An operation is a service that can be requested from an object to effect behavior. An operation has a signature, which describes the actual parameters that are possible (including possible return values).

In the metamodel, an Operation is a BehavioralFeature that can be applied to the Instances of the Classifier that contains the Operation.

2 UML Semantics

Attributes

<i>concurrency</i>	<p>Specifies the semantics of concurrent calls to the same passive instance (i.e., an Instance originating from a Classifier with <code>isActive=false</code>). Active instances control access to their own Operations so this property is usually (although not required in UML) set to sequential. Possibilities include:</p> <ul style="list-style-type: none">• sequential - Callers must coordinate so that only one call to an Instance (on any sequential Operation) may be outstanding at once. If simultaneous calls occur, then the semantics and integrity of the system cannot be guaranteed.• guarded - Multiple calls from concurrent threads may occur simultaneously to one Instance (on any guarded Operation), but only one is allowed to commence. The others are blocked until the performance of the first Operation is complete. It is the responsibility of the system designer to ensure that deadlocks do not occur due to simultaneous blocks. Guarded Operations must perform correctly (or block themselves) in the case of a simultaneous sequential Operation or guarded semantics cannot be claimed.• concurrent - Multiple calls from concurrent threads may occur simultaneously to one Instance (on any concurrent Operation). All of them may proceed concurrently with correct semantics. Concurrent Operations must perform correctly in the case of a simultaneous sequential or guarded Operation or concurrent semantics cannot be claimed.
<i>isAbstract</i>	<p>If true, then the operation does not have an implementation, and one must be supplied by a descendant. If false, the operation must have an implementation in the class or inherited from an ancestor.</p>
<i>isLeaf</i>	<p>If true, then the implementation of the operation may not be overridden by a descendant class. If false, then the implementation of the operation may be overridden by a descendant class (but it need not be overridden).</p>
<i>isRoot</i>	<p>If true, then the class must not inherit a declaration of the same operation. If false, then the class may (but need not) inherit a declaration of the same operation. (But the declaration must match in any case; a class may not modify an inherited operation declaration.)</p>

Tagged Values

<i>semantics</i>	Semantics is the specification of the meaning of the operation.
------------------	---

Parameter

A parameter is an unbound variable that can be changed, passed, or returned. A parameter may include a name, type, and direction of communication. Parameters are used in the specification of operations, messages and events, templates, etc.

In the metamodel, a Parameter is a declaration of an argument to be passed to, or returned from, an Operation, a Signal, etc.

Attributes

<i>defaultValue</i>	An Expression whose evaluation yields a value to be used when no argument is supplied for the Parameter.
<i>kind</i>	Specifies what kind of a Parameter is required. Possibilities are: <ul style="list-style-type: none"> • in - An input Parameter (may not be modified). • out - An output Parameter (may be modified to communicate information to the caller). • inout - An input Parameter that may be modified. • return - A return value of a call.
<i>name</i>	(Inherited from ModelElement) The name of the Parameter, which must be unique within its containing Parameter list.

Associations

<i>type</i>	Designates a Classifier to which an argument value must conform.
-------------	--

Permission

Permission is a kind of dependency. It grants a model element permission to access elements in another namespace.

In the metamodel, Permission is a Dependency between a client ModelElement and a supplier ModelElement. The client receives permission to reference the supplier's contents. The supplier must be a Namespace.

The predefined stereotypes of Permission are access, import, and friend.

In the case of the access and import stereotypes, the client is granted permission to reference elements in the supplier namespace with public visibility. In the case of the import stereotype, the public names in the supplier namespace are added to the client namespace. An element may also access any protected contents of an ancestor namespace. An element may also access any contents (public, protected, or private) of its own namespace or a containing namespace.

2 UML Semantics

In the case of the friend stereotype, the client is granted permission to reference elements in the supplier namespace, regardless of visibility.

Stereotypes

«access»	Access is a stereotyped permission dependency between two namespaces, denoting that the public contents of the target namespace are accessible to the namespace of the source package.
«friend»	Friend is a stereotyped permission dependency whose source is a model element, such as an operation, class, or package, and whose target is a model element in a different package, such as an operation, class or package. A friend relationship grants the source access to the target regardless of the declared visibility. It extends the visibility of the supplier so that the client can see into the supplier.
«import»	Import is a stereotyped permission dependency between two namespaces, denoting that the public contents of the target package are added to the namespace of the source package.

PresentationElement

A presentation element is a textual or graphical presentation of one or more model elements.

In the metamodel, a PresentationElement is an Element which presents a set of ModelElements to a reader. It is the base for all metaclasses used for presentation. All other metaclasses with this purpose are either direct or indirect subclasses of PresentationElement.

PresentationElement is an abstract metaclass. The subclasses of this class are proper to a graphic editor tool and are not specified here. It is a stub for their future definition.

Relationship

A relationship is a connection among model elements.

In the metamodel, Relationship is a term of convenience without any specific semantics. It is abstract.

Children of Relationship are Association, Dependency, Flow, and Generalization.

StructuralFeature

A structural feature refers to a static feature of a model element, such as an attribute.

In the metamodel, a StructuralFeature declares a structural aspect of an Instance of a Classifier, such as an Attribute. For example, it specifies the multiplicity and changeability of the StructuralFeature. StructuralFeature is an abstract metaclass.

See Attribute for the descriptions of the attributes and associations, as it is the only subclass of StructuralFeature in the current metamodel.

TemplateParameter

Defines the relationship between a template (a ModelElement) and its parameter (a ModelElement). A ModelElement with at least one templateParameter association is a template (by definition).

In the metamodel, TemplateParameter reifies the relationship between a ModelElement that is a template and a ModelElement that is a dummy placeholder for a template argument. See ModelElement on page 2-37, association templateParameter, for details.

Associations

<i>defaultElement</i>	An optional default value ModelElement. In case of a Binding of the template ModelElement in the reified TemplateParameter class association, the defaultElement is used as the argument of the bound element if no argument is supplied for the corresponding template parameter. If no argument is supplied and there is no default value, the model is ill formed.
-----------------------	---

Usage

A usage is a relationship in which one element requires another element (or set of elements) for its full implementation or operation. The relationship is not a mere historical artifact, but an ongoing need; therefore, two elements related by usage must be in the same model.

In the metamodel, a Usage is a Dependency in which the client requires the presence of the supplier. How the client uses the supplier, such as a class calling an operation of another class, a method having an argument of another class, and a method from a class instantiating another class, is defined in the description of the particular Usage stereotype.

Various stereotypes of Usage are predefined, but the set is open-ended and may be added to.

Stereotypes

«call»	Call is a stereotyped usage dependency whose source is an operation and whose target is an operation. The relationship may also be subsumed to the class containing an operation, with the meaning that there exists an operation in the class to which the dependency applies. A call dependency specifies that the source operation or an operation in the source class invokes the target operation or an operation in the target class. A call dependency may connect a source operation to any target operation that is within scope including, but not limited to, operations of the enclosing classifier and operations of other visible classifiers.
--------	--

«create»	Create is a stereotyped usage dependency denoting that the client classifier creates instances of the supplier classifier.
«instantiate»	A stereotyped usage dependency among classifiers indicating that operations on the client create instances of the supplier.
«send»	Send is a stereotyped usage dependency whose source is an operation and whose target is a signal, specifying that the source sends the target signal.

2.5.3 Well-Formedness Rules

The following well-formedness rules apply to the Core package.

Association

- [1] The AssociationEnds must have a unique name within the Association.

```
self.allConnections->forall( r1, r2 | r1.name = r2.name implies r1 = r2 )
```

- [2] At most one AssociationEnd may be an aggregation or composition.

```
self.allConnections->select(aggregation <#none)->size <= 1
```

- [3] If an Association has three or more AssociationEnds, then no AssociationEnd may be an aggregation or composition.

```
self.allConnections->size >=3 implies  
self.allConnections->forall(aggregation = #none)
```

- [4] The connected Classifiers of the AssociationEnds should be included in the Namespace of the Association.

```
self.allConnections->forall ( r |  
self.namespace.allContents->includes ( r.type ) )
```

Additional operations

- [1] The operation allConnections results in the set of all AssociationEnds of the Association.

```
allConnections : Set(AssociationEnd);  
allConnections = self.connection
```

AssociationClass

- [1] The names of the AssociationEnds and the StructuralFeatures do not overlap.

```
self.allConnections->forall( ar |  
self.allFeatures->forall( f |  
f.oclIsKindOf(StructuralFeature) implies ar.name <f.name ))
```

- [2] An AssociationClass cannot be defined between itself and something else.

```
self.allConnections->forAll(ar | ar.type <self)
```

Additional operations

- [1] The operation `allConnections` results in the set of all `AssociationEnds` of the `AssociationClass`, including all connections defined by its parent (transitive closure).

```
allConnections : Set(AssociationEnd);
allConnections = self.connection->union(self.parent->select
    (s | s.ocIsKindOf(Association))->collect (a : Association |
        a.allConnections))->asSet
```

AssociationEnd

- [1] The Classifier of an `AssociationEnd` cannot be an `Interface` or a `DataType` if the association is navigable away from that end.

```
(self.type.ocIsKindOf (Interface) or
self.type.ocIsKingOf (DataType)) implies
    self.association.connection->select
        (ae | ae <self)->forAll(ae | ae.isNavigable = #false)
```

- [2] An Instance may not belong by composition to more than one composite Instance.

```
self.aggregation = #composite implies self.multiplicity.max <= 1
```

Attribute

No extra well-formedness rules.

BehavioralFeature

- [1] All Parameters should have a unique name.

```
self.parameter->forAll(p1, p2 | p1.name = p2.name implies p1 = p2)
```

- [2] The type of the Parameters should be included in the Namespace of the Classifier.

```
self.parameter->forAll( p |
    self.owner.namespace.allContents->includes (p.type) )
```

Additional operations

- [1] The operation `hasSameSignature` checks if the argument has the same signature as the instance itself.

```
hasSameSignature ( b : BehavioralFeature ) : Boolean;
hasSameSignature (b) =
    (self.name = b.name) and
```

2 UML Semantics

```
(self.parameter->size = b.parameter->size) and
Sequence{ 1..(self.parameter->size) }->forall( index : Integer |
    b.parameter->at(index).type =
        self.parameter->at(index).type and
        b.parameter->at(index).kind =
            self.parameter->at(index).kind
    )
)
```

- [2] The operation `matchesSignature` checks if the argument has a signature that would clash with the signature of the instance itself (and therefore must be unique). Mismatches in kind or any differences in return parameters do not cause a mismatch:

```
matchesSignature ( b : BehavioralFeature ) : Boolean;
matchesSignature (b) =
    (self.name = b.name) and
    (self.parameter->size = b.parameter->size) and
    Sequence{ 1..(self.parameter->size) }->forall( index : Integer |
        b.parameter->at(index).type =
            self.parameter->at(index).type or
            (b.parameter->at(index).kind = return and
                self.parameter->at(index).kind = return)
        )
    )
```

Binding

- [1] The argument `ModelElement` must conform to the parameter `ModelElement` in a `Binding`. In an instantiation it must be of the same kind.

- [2] A `Binding` has one client and one supplier.

```
(self.client->size = 1) and (self.supplier->size = 1)
```

- [3] A `ModelElement` may participate in at most one `Binding` as a client.

```
Binding.allInstances->forall
    [b1, b2 | (b1 <> b2) implies (b1.client <> b2.client)]
```

Class

- [1] If a `Class` is concrete, all the `Operations` of the `Class` should have a realizing `Method` in the full descriptor.

```
not self.isAbstract implies self.allOperations->forall (op |
    self.allMethods->exists (m | m.specification->includes(op)))
```

- [2] A Class can only contain Classes, Associations, Generalizations, UseCases, Constraints, Dependencies, Collaborations, DataTypes, and Interfaces as a Namespace.

```
self.allContents->forall->(c |
    c.ocIsKindOf(Class ) or
    c.ocIsKindOf(Association ) or
    c.ocIsKindOf(Generalization) or
    c.ocIsKindOf(UseCase ) or
    c.ocIsKindOf(Constraint ) or
    c.ocIsKindOf(Dependency ) or
    c.ocIsKindOf(Collaboration ) or
    c.ocIsKindOf(DataType ) or
    c.ocIsKindOf(Interface )
```

Classifier

- [1] No BehavioralFeature of the same kind may match the same signature in a Classifier.

```
self.feature->forall(f, g |
(
    (
        (f.ocIsKindOf(Operation) and g.ocIsKindOf(Operation)) or
        (f.ocIsKindOf(Method ) and g.ocIsKindOf(Method ) ) or
        (f.ocIsKindOf(Reception) and g.ocIsKindOf(Reception))
    ) and
    f.ocAsType(BehavioralFeature).matchesSignature(g)
)
implies f = g)
```

- [2] No Attributes may have the same name within a Classifier.

```
self.feature->select ( a | a.ocIsKindOf (Attribute) )->forall ( p, q |
    p.name = q.name implies p = q )
```

- [3] No opposite AssociationEnds may have the same name within a Classifier.

```
self.oppositeEnds->forall ( p, q | p.name = q.name implies p = q )
```

- [4] The name of an Attribute may not be the same as the name of an opposite AssociationEnd or a ModelElement contained in the Classifier.

```
self.feature->select ( a | a.ocIsKindOf (Attribute) )->forall ( a |
    not self.allOppositeAssociationEnds->union (self.allContents)-
    >collect ( q |
```

2 UML Semantics

```
q.name )->includes (a.name) )
```

- [5] The name of an opposite AssociationEnd may not be the same as the name of an Attribute or a ModelElement contained in the Classifier.

```
self.oppositeAssociationEnds->forall ( o |
    not self.allAttributes->union (self.allContents)->collect ( q |
        q.name )->includes (o.name) )
```

- [6] For each Operation in an specification realized by the Classifier, the Classifier must have a matching Operation.

```
self.specification.allOperations->forall (interOp |
    self.allOperations->exists( op | op.hasMatchingSignature
    (interOp) ) )
```

- [7] All of the generalizations in the range of a powertype have the same discriminator.

```
self.powertypeRange->forall
    (g1, g2 | g1.discriminator = g2.discriminator)
```

- [8] Discriminator names must be distinct from attribute names and opposite AssociationEnd names.

```
self.allDiscriminators->intersection (self.allAttributes.name->union
    (self.allOppositeAssociationEnds.name))->isEmpty
```

Additional operations

- [1] The operation allFeatures results in a Set containing all Features of the Classifier itself and all its inherited Features.

```
allFeatures : Set(Feature);
allFeatures = self.feature->union(
    self.parent.oclAsType(Classifier).allFeatures)
```

- [2] The operation allOperations results in a Set containing all Operations of the Classifier itself and all its inherited Operations.

```
allOperations : Set(Operation);
allOperations = self.allFeatures->select(f | f.oclIsKindOf(Operation))
```

- [3] The operation allMethods results in a Set containing all Methods of the Classifier itself and all its inherited Methods.

```
allMethods : set(Method);
allMethods = self.allFeatures->select(f | f.oclIsKindOf(Method))
```

- [4] The operation allAttributes results in a Set containing all Attributes of the Classifier itself and all its inherited Attributes.

```
allAttributes : set(Attribute);
allAttributes = self.allFeatures->select(f | f.oclIsKindOf(Attribute))
```

- [5] The operation `associations` results in a Set containing all Associations of the Classifier itself.

```
associations : set(Association);
associations = self.associationEnd.association->asSet
```

- [6] The operation `allAssociations` results in a Set containing all Associations of the Classifier itself and all its inherited Associations.

```
allAssociations : set(Association);
allAssociations = self.associations->union (
    self.parent.oclAsType(Classifier).allAssociations)
```

- [7] The operation `oppositeAssociationEnds` results in a set of all AssociationEnds that are opposite to the Classifier.

```
oppositeAssociationEnds : Set (AssociationEnd);
oppositeAssociationEnds =
    self.association->select ( a | a.associationEnd->select ( ae |
        ae.type = self ).size = 1 )->collect ( a |
        a.associationEnd->select ( ae | ae.type <self ) )->union
(
    self.association->select ( a | a.associationEnd->select ( ae |
        ae.type = self ).size 1 )->collect ( a |
        a.associationEnd) )
```

- [8] The operation `allOppositeAssociationEnds` results in a set of all AssociationEnds, including the inherited ones, that are opposite to the Classifier.

```
allOppositeAssociationEnds : Set (AssociationEnd);
allOppositeAssociationEnds = self.oppositeAssociationEnds->union (
    self.parent.allOppositeAssociationEnds )
```

- [9] The operation `specification` yields the set of Classifiers that the current Classifier realizes.

```
specification: Set(Classifier)
specification = self.clientDependency->
    select(d |
        d.oclIsKindOf(Abstraction)
        and d.stereotype.name = "realization"
        and d.supplier.oclIsKindOf(Classifier))
    .supplier.oclAsType(Classifier)
```

- [10] The operation `allContents` returns a Set containing all ModelElements contained in the Classifier together with the contents inherited from its parents.

```
allContents : Set(ModelElement);
allContents = self.contents->union(
```

2 UML Semantics

```
self.parent.allContents->select(e |
    e.elementOwnership.visibility = #public or
    e.elementOwnership.visibility = #protected))
```

- [11] The operation `allDiscriminators` results in a Set containing all Discriminators of the Generalizations from which the Classifier is descended itself and all its inherited Features.

```
allDiscriminators : Set(Name);
allDiscriminators = self.generalization.discriminator->union(
    self.parent.oclAsType(Classifier).allDiscriminators)
```

Comment

No extra well-formedness rules.

Component

- [1] A Component may only contain other Components.

```
self.allContents-forAll( c | c.ocIsKindOf(Component) )
```

- [2] A Component may only implement DataTypes, Interfaces, Classes, Associations, Dependencies, Constraints, Signals, DataValues and Objects.

```
self.allResidentElements -forall( re |
    re.ocIsKindOf(DataType) or
    re.ocIsKindOf(Interface) or
    re.ocIsKindOf(Class) or
    re.ocIsKindOf(Association) or
    re.ocIsKindOf(Dependency) or
    re.ocIsKindOf(Constraint) or
    re.ocIsKindOf(Signal) or
    re.ocIsKindOf(DataValue) or
    re.ocIsKindOf(Object) )
```

Additional operations

- [1] The operation `allResidentElements` results in a Set containing all ModelElements resident in a Component or one of its ancestors.

```
allResidentElements : set(ModelElement)
allResidentElements = self.resident->union(
    self.parent.oclAsType(Component).allResidentElements->select(
re |
```

```

re.elementResidence.visibility = #public or
re.elementResidence.visibility = #protected))

```

- [2] The operation `allVisibleElements` results in a Set containing all ModelElements visible outside the Component.

```

allVisibleElements : Set(ModelElement)
allVisibleElements = self.allContents -select( e |
    e.elementOwnership.visibility = #public) -union (
    self.allResidentElements -select ( re |
        re.elementResidence.visibility = #public))

```

Constraint

- [1] A Constraint cannot be applied to itself.

```

not self.constrainedElement->includes (self)

```

DataType

- [1] A DataType can only contain Operations, which all must be queries.

```

self.allFeatures->forAll(f |
    f.ocIsKindOf(Operation) and
    f.ocIsType(Operation).isQuery)

```

- [2] A DataType cannot contain any other ModelElements.

```

self.allContents->isEmpty

```

Dependency

No extra well-formedness rules.

Element

No extra well-formedness rules.

ElementOwnership

No additional well-formedness rules.

ElementResidence

No additional well-formedness rules.

2 UML Semantics

Feature

No extra well-formedness rules.

GeneralizableElement

[1] A root cannot have any Generalizations.

```
self.isRoot implies self.generalization->isEmpty
```

[2] No GeneralizableElement can have a parent Generalization to an element which is a leaf.

```
self.parent->forall(s | not s.isLeaf)
```

[3] Circular inheritance is not allowed.

```
not self.allParents->includes(self)
```

[4] The parent must be included in the Namespace of the GeneralizableElement.

```
self.generalization->forall(g |  
    self.namespace.allContents->includes(g.parent) )
```

Additional Operations

[1] The operation parent returns a Set containing all direct parents.

```
parent : Set(GeneralizableElement);  
parent = self.generalization.parent
```

[2] The operation allParents returns a Set containing all the Generalizable Elements inherited by this GeneralizableElement (the transitive closure), excluding the GeneralizableElement itself.

```
allParents : Set(GeneralizableElement);  
allParents = self.parent->union(self.parent.allParents)
```

Generalization

[1] A GeneralizableElement may only be a child of GeneralizableElement of the same kind.

ImplementationClass (stereotype of Class)

[1] All direct instances of an implementation class must not have any other Classifiers that are implementation classes.

```
self.instance.forall(i | i.classifier.forall(c |  
    c.stereotype.name = "implementationClass" implies c = self))
```

[2] A parent of an implementation class must be an implementation class.

```
self.parent->forall(stereotype.name="implementationClass")
```

Interface

- [1] An Interface can only contain Operations.

```
self.allFeatures->forall(f |
    f.ocIsKindOf(Operation) or f.ocIsKindOf(Reception))
```

- [2] An Interface cannot contain any ModelElements.

```
self.allContents->isEmpty
```

- [3] All Features defined in an Interface are public.

```
self.allFeatures->forall ( f | f.visibility = #public )
```

Method

- [1] If the realized Operation is a query, then so is the Method.

```
self.specification->isQuery implies self.isQuery
```

- [2] The signature of the Method should be the same as the signature of the realized Operation.

```
self.hasSameSignature (self. specification)
```

- [3] The visibility of the Method should be the same as for the realized Operation.

```
self.visibility = self.specification.visibility
```

- [4] The realized Operation must be a feature (possibly inherited) of the same Classifier as the Method.

```
self.owner.allOperations->includes(self.specification)
```

- [5] If the realized Operation has been overridden one or more times in the ancestors of the owner of the Method, then the Method must realize the latest overriding (that is, all other Operations with the same signature must be owned by ancestors of the owner of the realized Operation).

```
self.specification.owner.allOperations->includesAll(
    (self.owner.allOperations->select(op |
        self.hasSameSignature(op)))
```

ModelElement

That part of the model owned by a template is not subject to all well-formedness rules. A template is not directly usable in a well-formed model. The results of binding a template are subject to well-formedness rules.

```
(not expressed in OCL)
```

Additional operations

- [1] The operation supplier results in a Set containing all direct suppliers of the ModelElement.

```
supplier : Set(ModelElement);
```

2 UML Semantics

```
supplier = self.clientDependency.supplier
```

- [2] The operation `allSuppliers` results in a Set containing all the ModelElements that are suppliers of this ModelElement, including the suppliers of these ModelElements. This is the transitive closure.

```
allSuppliers : Set(ModelElement);  
allSuppliers = self.supplier->union(self.supplier.allSuppliers)
```

- [3] The operation “model” results in the set of Models to which the ModelElement belongs.

```
model : Set(Model);  
model = self.namespace->union(self.namespace.allSurroundingNamespaces)  
->select( ns |  
          ns.ocIsKindOf (Model))
```

- [4] A ModelElement is a template when it has parameters.

```
isTemplate : Boolean;  
isTemplate = (self.templateParameter->notEmpty)
```

- [5] A ModelElement is an instantiated template when it is related to a template by a Binding relationship.

```
isInstantiated : Boolean;  
isInstantiated = self.clientDependency->select(  
  ocIsKindOf(Binding))->notEmpty
```

- [6] The templateArguments are the arguments of an instantiated template, which substitute for template parameters.

```
templateArguments : Set(ModelElement);  
templateArguments = self.clientDependency->  
  
select(ocIsKindOf(Binding)).oclAsType(Binding).argument
```

Namespace

- [1] If a contained element, which is not an Association or Generalization has a name, then the name must be unique in the Namespace.

```
self.allContents->forall(me1, me2 : ModelElement |  
  ( not me1.ocIsKindOf (Association) and not me2.ocIsKindOf  
(Association) and  
  me1.name <' ' and me2.name <' ' and me1.name = me2.name  
  ) implies  
  me1 = me2 )
```

- [2] All Associations must have a unique combination of name and associated Classifiers in the Namespace.

```

self.allContents -> select(oclIsKindOf(Association))->
  forAll(a1, a2 |
    a1.name = a2.name and
    a1.connection.type = a2.connection.type
    implies a1 = a2)

```

Additional operations

- [1] The operation contents results in a Set containing all ModelElements contained by the Namespace.

```

contents : Set(ModelElement)
contents = self.ownedElement -> union(self.namespace, contents)

```

- [2] The operation allContents results in a Set containing all ModelElements contained by the Namespace.

```

allContents : Set(ModelElement);
allContents = self.contents

```

- [3] The operation allVisibleElements results in a Set containing all ModelElements visible outside of the Namespace.

```

allVisibleElements : Set(ModelElement)
allVisibleElements = self.allContents -> select(e |
  e.elementOwnership.visibility = #public)

```

- [4] The operation allSurroundingNamespaces results in a Set containing all surrounding Namespaces.

```

allSurroundingNamespaces : Set(Namespace)
allSurroundingNamespaces =
  self.namespace->union(self.namespace.allSurroundingNamespaces)

```

Node

No extra well-formedness rules.

Operation

No additional well-formedness rules.

Parameter

No additional well-formedness rules.

PresentationElement

No extra well-formedness rules.

2 UML Semantics

StructuralFeature

- [1] The connected type should be included in the owner's Namespace.

```
self.owner.namespace.allContents->includes(self.type)
```

- [2] The type of a StructuralFeature must be a Class, DataType or Interface.

```
self.type.ocIsKindOf(Class) or  
self.type.ocIsKindOf(DataType) or  
self.type.ocIsKindOf(Interface)
```

Trace

A trace is an Abstraction with the «trace» stereotype. These are the additional constraints due to the stereotype.

- [1] The client ModelElements of a Trace must all be from the same Model.

```
self.client->forAll(e1, e2 | e1.model = e2.model)
```

- [2] The supplier ModelElements of a Trace must all be from the same Model.

```
self.supplier->forAll(e1, e2 | e1.model = e2.model)
```

- [3] The client and supplier ModelElements must be from two different Models.

```
self.client.model <self.supplier.model
```

- [4] The client and supplier ModelElements must all be from models of the same system.

```
self.client.model.intersection(self.supplier.model) <Set{}
```

Type (stereotype of Class)

- [1] A Type may not have any Methods.

```
not self.feature->exists(ocIsKindOf(Method))
```

- [2] The parent of a type must be a type.

```
self.parent->forAll(stereotype.name = "type")
```

Usage

No extra well-formedness rules.

2.5.4 Semantics

This section provides a description of the dynamic semantics of the elements in the Core. It is structured based on the major constructs in the core, such as interface, class, and association.

Association

An association declares a connection (link) between instances of the associated classifiers (e.g., classes). It consists of at least two association ends, each specifying a connected classifier and a set of properties which must be fulfilled for the relationship to be valid. The multiplicity property of an association end specifies how many instances of the classifier at a given end (the one bearing the multiplicity value) may be associated with a single instance of the classifier at the other end. A multiplicity is a range of nonnegative integers. The association end also states whether or not the connection may be traversed towards the instance playing that role in the connection (`isNavigable`), for instance, if the instance is directly reachable via the association. An association-end also specifies whether or not an instance playing that role in a connection may be replaced by another instance. It may state

- that no constraints exist (`changeable`),
- that the link cannot be modified once it has been initialized (`frozen`), or
- that new links of the association may be added but not removed or altered (`addOnly`).

These constraints do not affect the modifiability of the objects themselves that are attached to the links. Moreover, `ordering` the classifier, or (a child of) the classifier itself. The `ordering` attribute of association-end states that if the instances related to a single instance at the other end have an ordering that must be preserved, the order of insertion of new links must be specified by operations that add or modify links. Note that sorting is a performance optimization and is not an example of a logically ordered association, because the ordering information in a sort does not add any information.

In UML, Associations can be of three different kinds: 1) ordinary association, 2) composite aggregate, and 3) shared aggregate. Since the aggregate construct can have several different meanings depending on the application area, UML gives a more precise meaning to two of these constructs (i.e., association and composite aggregate) and leaves the shared aggregate more loosely defined in between.

An association may represent an aggregation (i.e., a whole/part relationship). In this case, the association-end attached to the whole element is designated, and the other association-end of the association represents the parts of the aggregation. Only binary associations may be aggregations. Composite aggregation is a strong form of aggregation which requires that a part instance be included in at most one composite at a time and that the composite object has sole responsibility for the disposition of its parts. This means that the composite object is responsible for the creation and destruction of the parts. In implementation terms, it is responsible for their memory allocation. If a composite object is destroyed, it must destroy all of its parts. It may remove a part and give it to another composite object, which then assumes responsibility for it. If the multiplicity from a part to composite is zero-to-one, the composite may remove the part and the part may assume responsibility for itself, otherwise it may not live apart from a composite.

A consequence of these rules is that a composite implies propagation semantics (i.e., some of the dynamic semantics of the whole is propagated to its parts). For example, if the whole is copied or destroyed, then so are the parts as well (because a part may belong to at most one composite).

2 UML Semantics

A shared aggregation denotes weak ownership (i.e., the part may be included in several aggregates) and its owner may also change over time. However, the semantics of a shared aggregation does not imply deletion of the parts when an aggregate referencing it is deleted. Both kinds of aggregations define a transitive, antisymmetric relationship (i.e., the instances form a directed, non-cyclic graph). Composition instances form a strict tree (or rather a forest).

A qualifier declares a partition of the set of associated instances with respect to an instance at the qualified end (the qualified instance is at the end to which the qualifier is attached). A qualifier instance comprises one value for each qualifier attribute. Given a qualified object and a qualifier instance, the number of objects at the other end of the association is constrained by the declared multiplicity. In the common case in which the multiplicity is 0..1, the qualifier value is unique with respect to the qualified object, and designates at most one associated object. In the general case of multiplicity 0..*, the set of associated instances is partitioned into subsets, each selected by a given qualifier instance. In the case of multiplicity 1 or 0..1, the qualifier has both semantic and implementation consequences. In the case of multiplicity 0..*, it has no real semantic consequences but suggests an implementation that facilitates easy access of sets of associated instances linked by a given qualifier value.

Note that the multiplicity of a qualifier is given assuming that the qualifier value is supplied. The “raw” multiplicity without the qualifier is assumed to be 0..*. This is not fully general but it is almost always adequate, as a situation in which the raw multiplicity is 1 would best be modeled without a qualifier.

Note also that a qualified multiplicity whose lower bound is zero indicates that a given qualifier value may be absent, while a lower bound of 1 indicates that any possible qualifier value must be present. The latter is reasonable only for qualifiers with a finite number of values (such as enumerated values or integer ranges) that represent full tables indexed by some finite range of values.

AssociationClass

An association may be refined to have its own set of features (i.e., features that do not belong to any of the connected classifiers) but rather to the association itself. Such an association is called an association class. It will be both an association, connecting a set of classifiers, and a class, and as such have features and be included in other associations. The semantics of such an association is a combination of the semantics of an ordinary association and of a class.

The AssociationClass construct can be expressed in a few different ways in the metamodel (e.g., as a subclass of Class, as a subclass of Association, or as a subclass of Classifier). Since an AssociationClass is a construct being both an association (having a set of association-ends) and a class (declaring a set of features), the most accurate way of expressing it is as a subclass of both Association and Class. In this way, AssociationClass will have all the properties of the other two constructs. Moreover, if new kinds of associations containing features (e.g., AssociationDataType) are to be included in UML, these are easily added as subclasses of Association and the other Classifier.

The terms child, subtype, and subclass are synonyms and mean that an instance of a classifier being a subtype of another classifier can always be used where an instance of the latter classifier is expected. The neutral terms *parent* and *child*, with the transitive closures *ancestor* and *descendant*, are the preferred terms in this document.

Class

The purpose of a class is to declare a collection of methods, operations, and attributes that fully describe the structure and behavior of objects. All objects instantiated from a class will have attribute values matching the attributes of the full class descriptor and support the operations found in the full class descriptor. Some classes may not be directly instantiated. These classes are said to be abstract and exist only for other classes to inherit and reuse the features declared by them. No object may be a direct instance of an abstract class, although an object may be an indirect instance of one through a subclass that is non-abstract.

When a class is instantiated to create a new object, a new instance is created, which is initialized containing an attribute value for each attribute found in the full class descriptor. The object is also initialized with a connection to the list of methods in the full class descriptor.

Note – An actual implementation behaves as if there were a full class descriptor, but many clever optimizations are possible in practice.

Finally, the identity of the new object is returned to the creator. The identity of every instance in a well-formed system is unique and automatic.

A class can have generalizations to other classes. This means that the full class descriptor of a class is derived by inheritance from its own segment declaration and those of its ancestors. Generalization between classes implies substitutability (i.e., an instance of a class may be used whenever an instance of a superclass is expected). If the class is specified as a root, it cannot be a subclass of other classes. Similarly, if it is specified as a leaf, no other class can be a subclass of the class.

Each attribute declared in a class has a visibility and a type. The visibility defines if the attribute is publicly available to any class, if it is only available inside the class and its subclasses (protected), or if it can only be used inside the class (private). The `targetScope` of the attribute declares whether its value should be an instance (of a child) of that type or if it should be (a child of) the type itself. There are two alternatives for the `ownerScope` of an attribute:

- it may state that each object created by the class (or by its subclasses) has its own value of the attribute, or
- that the value is owned by the class itself.

An attribute also declares how many attribute values should be connected to each owner (multiplicity), what the initial values should be, and if these attribute values may be changed to:

- none - no constraints exists,
- frozen - the value cannot be replaced or added to once it has been initialized, or
- addOnly - new values may be added to a set but not removed or altered.

For each operation, the operation name, the types of the parameters, and the return type(s) are specified, as well as its visibility (see above). An operation may also include a specification of the effects of its invocation. The specification can be done in several different ways (e.g., with pre- and post-conditions, pseudo-code, or just plain text). Each operation declares if it is applicable to the instances, the class, or to the class itself (`ownerScope`). Furthermore, the operation states whether or not its application will modify the state of the object (`isQuery`). The

2 UML Semantics

operation also states whether or not the operation may be realized by a different method in a subclass (*isPolymorphic*). A method realizing an operation has the same signature as the operation and a body implementing the specification of the operation. Methods in descendants override and replace methods inherited from ancestors (see “Inheritance” on page 2-60). Each method implements an operation declared in the class or inherited from an ancestor. The same operation may be declared more than once in a full class descriptor, but their descriptions must all match, except that the generalization properties (*isRoot*, *IsAbstract*, *isLeaf*) may vary, and a child operation may strengthen query properties (the child may be a query even though the parent is not). The specification of the method must match the specification of its matching operation, as defined above for operations. Furthermore, if the *isQuery* attribute of an operation is true, then it must also be true in any realizing method. However, if it is false in the operation, it may still be true in the method if the method does not actually modify the state to carry out the behavior required by the operation (this can only be true if the operation does not inherently modify state). The visibility of a method must match its operation.

Classes may have associations to each other. This implies that objects created by the associated classes are semantically connected (i.e., that links exist between the objects, according to the requirements of the associations). See *Association* on the next page. Associations are inherited by subclasses.

A class may realize a set of interfaces. This means that each operation found in the full descriptor for any realized interface must be present in the full class descriptor with the same specification (see Semantics section Inheritance on page 2-60). The relationship between interface and class is not necessarily one-to-one; a class may offer several interfaces and one interface may be offered by more than one class. The same operation may be defined in multiple interfaces that a class supports; if their specifications are identical then there is no conflict; otherwise, the model is ill-formed. Moreover, a class may contain additional operations besides those found in its interfaces.

A class acts as the namespace for various kinds of contained elements defined within its scope, including classes, interfaces and associations (note that this is purely a scoping construction and does not imply anything about aggregation), the contained classifiers can be used as ordinary classifiers in the container class. If a class inherits another class, the contents of the ancestor are available to its descendants if the visibility of an element is public or protected; however, if the visibility is private, then the element is not visible and therefore not available in the descendant.

Inheritance

To understand inheritance it is first necessary to understand the concept of a full descriptor and a segment descriptor. A full descriptor is the full description needed to describe an object or other instance (see “Instantiation” on page 2-61). It contains a description of all of the attributes, associations, and operations that the object contains. In a pre-object-oriented language, the full descriptor of a data structure was declared directly in its entirety. In an object-oriented language, the description of an object is built out of incremental segments that are combined using inheritance to produce a full descriptor for an object. The segments are the modeling elements that are actually declared in a model. They include elements such as class and other generalizable elements. Each generalizable element contains a list of features and other relationships that it adds to what it inherits from its ancestors. The mechanism of inheritance defines how full descriptors are produced from a set of segments connected by generalization. The full descriptors are implicit, but they define the structure of actual instances.

Each kind of generalizable element has a set of inheritable features. For any model element, these include constraints. For classifiers, these include features (attributes, operations, signal receptions, and methods) and participation in associations. The ancestors of a generalizable element are its parents (if any) together with all of their ancestors (with duplicates removed). For a Namespace (such as a Package or a Class with nested declarations), the public or protected contents of the Namespace are available to descendants of the Namespace.

If a generalizable element has no parent, then its full descriptor is the same as its segment descriptor. If a generalizable element has one or more parents, then its full descriptor contains the union of the features from its own segment descriptor and the segment descriptors of all of its ancestors. For a classifier, no attribute, operation, or signal with the same signature may be declared in more than one of the segments (in other words, they may not be redefined). A method may be declared in more than one segment. A method declared in any segment supersedes and replaces a method with the same signature declared in any ancestor. If two or more methods nevertheless remain, then they conflict and the model is ill-formed. The constraints on the full descriptor are the union of the constraints on the segment itself and all of its ancestors. If any of them are inconsistent, then the model is ill-formed.

In any full descriptor for a classifier, each method must have a corresponding operation. In a concrete classifier, each operation in its full descriptor must have a corresponding method in the full descriptor.

The purpose of the full descriptor is explained under “Instantiation” on page 2-61.

Instantiation

The purpose of a model is to describe the possible states of a system and their behavior. The state of a system comprises objects, values, and links. Each object is described by a full class descriptor. The class corresponding to this descriptor is the direct class of the object. If an object is not completely described by a single class (multiple classification), then any class in the minimal set of unrelated (by generalization) classes whose union completely describes the object is a direct class of the object. Similarly each link has a direct association and each value has a direct data type. Each of these instances is said to be a direct instance of the classifier from which its full descriptor was derived. An instance is an indirect instance of the classifier or any of its ancestors.

The data content of an object comprises one value for each attribute in its full class descriptor (and nothing more). The value must be consistent with the type of the attribute. The data content of a link comprises a tuple containing a list of instances, one that is an indirect instance of each participant classifier in the full association descriptor. The instances and links must obey any constraints on the full descriptors of which they are instances (including both explicit constraints and built-in constraints such as multiplicity).

The state of a system is a valid system instance if every instance in it is a direct instance of some element in the system model and if all of the constraints imposed by the model are satisfied by the instances.

The behavioral parts of UML describe the valid sequences of valid system instances that may occur as a result of both external and internal behavioral effects.

Interface

The purpose of an interface is to collect a set of operations that constitute a coherent service offered by classifiers. Interfaces provide a way to partition and characterize groups of operations. An interface is only a collection of operations with a name. It cannot be directly instantiated. Instantiable classifiers, such as class or use case, may use interfaces for specifying different services offered by their instances. Several classifiers may realize the same interface. All of them must contain at least the operations matching those contained in the interface. The specification of an operation contains the signature of the operation (i.e., its name, the types of the parameters and the return type). An interface does not imply any internal structure of the realizing classifier. For example, it does not define which algorithm to use for realizing an operation. An operation may, however, include a specification of the effects of its invocation. The specification can be done in several different ways (e.g., with pre and post-conditions, pseudo-code, or just plain text).

Each operation declares if it applies to the instances of the classifier declaring it or to the classifier itself (e.g., a constructor on a class (ownerScope)). Furthermore, the operation states whether or not its application will modify the state of the instance (isQuery). The operation also states whether or not all the classes must have the same realization of the operation (isPolymorphic).

An interface can be a child of other interfaces denoted by generalizations. This means that a classifier offering the interface must provide not only the operations declared in the interface but also those declared in the ancestors of the interface. If the interface is specified as a root, it cannot be a child of other interfaces. Similarly, if it is specified as a leaf, no other interface can be a child of the interface.

Operation

Operation is a conceptual construct, while Method is the implementation construct. Their common features, such as having a signature, are expressed in the BehavioralFeature metaclass, and the specific semantics of the Operation. The Method constructs are defined in the corresponding subclasses of BehavioralFeature.

PresentationElement

The responsibility of presentation element is to provide a textual and graphical projection of a collection of model elements. In this context, projection means that the presentation element represents a human readable notation for the corresponding model elements. The notation for UML can be found in Chapter 3 of this document.

Presentation elements and model elements must be kept in agreement, but the mechanisms for doing this are design issues for model editing tools.

Template

A template is a parameterized model element that cannot be used directly in a model. Instead, it may be used to generate other model elements using the Binding relationship; those generated model elements can be used in normal relationships with other elements.

A template represents the parameterization of a model element, such as a class or an operation, although conceptually any model element may be used (but not all may be useful). The template element is attached by composite aggregation to an ordered list of parameter elements. Each parameter element has a name that represents a parameter name within the template element. Any use of the name within the scope of the template element represents an unbound parameter that is to be replaced by an actual value in a Binding of the template. For example, a parameter may represent the type of an attribute of a class (for a class template). The corresponding attribute would have an association to the template parameter as its type.

Note that the scope of the template includes all of the elements recursively owned by it through composite aggregation. For example, a parameterized class template owns its attributes, operations, and so on. Neither the parameterized elements nor its contents may be used directly in a model without binding.

A template element has the templateParameter association to a list of ModelElements that serve as its parameters. To avoid introducing metamodel (M2) elements in an ordinary (M1) model, the model contains a representative of each parameter element, rather than the type of the parameter element. For example, a frequent kind of parameter is a class. Instead of including the metaclass Class in the (M1) ordinary model, a dummy class must be declared whose name is the name of the parameter. This dummy element is meaningful only within the template (it may not be used within the wider model) and it has no features (such as attributes and operations), because the features are part of an actual element that is supplied when the template is bound. Because a template parameter is only a dummy that lacks internal structure, it may violate well-formedness constraints of elements of its kind; the actual elements supplied during binding must satisfy ordinary well-formedness constraints.

Note also that when the template is bound, the bound element does not show the explicit structure of an element of its kind; it is a stub. Its semantics and well-formedness rules must be evaluated as if the actual substitutions of actual elements for parameters had been made; but the expansions are not explicitly shown in a canonical model as they are regarded as derived.

A template element is therefore effectively isolated from the directly-usable part of the model and is indirectly connected to its ultimate instances through Binding associations to bound elements. The bound elements may be used in ordinary models in places where the model element underlying the template could be used.

Miscellaneous

A constraint is a Boolean expression over one or several elements which must always be true. A constraint can be specified in several different ways (e.g., using natural language or a constraint language).

A dependency specifies that the semantics of a set of model elements requires the presence of another set of model elements. This implies that if the source is somehow modified, the dependents probably must be modified. The reason for the dependency can be specified in several different ways (e.g., using natural language or an algorithm) but is often implicit.

A Usage or Binding dependency can be established only between elements in the same model, since the semantics of a model cannot be dependent on the semantics of another model. If a connection is to be established between elements in different models, a Trace or Refinement should be used. Refinement can connect elements in different or same models.

2 UML Semantics

Whenever the supplier element of a dependency changes, the client element is potentially invalidated. After such invalidation, a check should be performed followed by possible changes to the derived client element. Such a check should be performed after which action can be taken to change the derived element to validate it again. The semantics of this validation and change is outside the scope of UML.

A data type is a special kind of classifier, similar to a class, but whose instances are primitive values (not objects). For example, the integers and strings are usually treated as primitive values. A primitive value does not have an identity, so two occurrences of the same value cannot be differentiated. Usually, it is used for specification of the type of an attribute. An enumeration type is a user-definable type comprising a finite number of values.

2.6 Extension Mechanisms

2.6.1 Overview

The Extension Mechanisms package is the subpackage that specifies how model elements are customized and extended with new semantics. It defines the semantics for stereotypes, constraints, and tagged values.

The UML provides a rich set of modeling concepts and notations that have been carefully designed to meet the needs of typical software modeling projects. However, users may sometimes require additional features and/or notations beyond those defined in the UML standard. In addition, users often need to attach non-semantic information to models. These needs are met in UML by three built-in extension mechanisms that enable new kinds of modeling elements to be added to the modeler's repertoire as well as to attach free-form information to modeling elements. These three extension mechanisms can be used separately or together to define new modeling elements that can have distinct semantics, characteristics, and notation relative to the built in UML modeling elements specified by the UML metamodel. Concrete constructs defined in Extension Mechanisms include Constraint, Stereotype, and TaggedValue.

The UML extension mechanisms are intended for several purposes:

- To add new modeling elements for use in creating UML models.
- To define standard items that are not considered interesting or complex enough to be defined directly as UML metamodel elements.
- To define process-specific or implementation language-specific extensions.
- To attach arbitrary semantic and non-semantic information to model elements.

Although it is beyond the scope and intent of this document, it is also possible to extend the UML metamodel by explicitly adding new metaclasses and other meta constructs. This capability depends on unique features of certain UML-compatible modeling tools, or direct use of a meta-metamodel facility, such as the CORBA Meta Object Facility (MOF).

The most important of the built-in extension mechanisms is based on the concept of Stereotype. Stereotypes provide a way of classifying model elements at the object model level and facilitate the addition of "virtual" UML metaclasses with new metaattributes and semantics. The other built in extension mechanisms are based on the notion of property lists consisting of tags and values, and constraints. These allow users to attach additional properties and semantics directly to individual model elements, as well as to model elements classified by a Stereotype.

A stereotype is a UML model element that is used to classify (or mark) other UML elements so that they behave in some respects as if they were instances of new "virtual" or "pseudo" metamodel classes whose form is based on existing "base" classes. Stereotypes augment the classification mechanism based on the built in UML metamodel class hierarchy; therefore, names of new stereotypes must not clash with the names of predefined metamodel elements or other stereotypes. Any model element can be marked by at most one stereotype, but any stereotype can be constructed as a specialization of numerous other stereotypes.

2 UML Semantics

A stereotype may introduce additional values, additional constraints, and a new graphical representation. All model elements that are classified by a particular stereotype ("stereotyped") receive these values, constraints, and representation. By allowing stereotypes to have associated graphical representations users can introduce new ways of graphically distinguishing model elements classified by a particular stereotype.

A stereotype shares the attributes, associations, and operations of its base class but it may have additional well-formedness constraints as well as a different meaning and attached values. The intent is that a tool or repository be able to manipulate a stereotyped element the same as the ordinary element for most editing and storage purposes, while differentiating it for certain semantic operations, such as well-formedness checking, code generation, or report writing.

Any modeling element may have arbitrary attached information in the form of a property list consisting of tag-value pairs. A tag is a name string that is unique for a given element that selects an associated arbitrary value. Values may be arbitrary but for uniform information exchange they should be represented as strings. The tag represents the name of an arbitrary property with the given value. Tags may be used to represent management information (author, due date, status), code generation information (optimizationLevel, containerClass), or additional semantic information required by a given stereotype.

It is possible to specify a list of tags (with default values, if desired) that are required by a particular stereotype. Such required tags serve as "pseudoattributes" of the stereotype to supplement the real attributes supplied by the base element class. The values permitted to such tags can also be constrained.

It is not necessary to stereotype a model element in order to give it individually distinct constraints or tagged values. Constraints can be directly attached to a model element (stereotyped or not) to change its semantics. Likewise, a property list consisting of tag-value pairs can be directly attached to any model element. The tagged values of a property list allow characteristics to be assigned to model elements on a flexible, individual basis. Tags are user-definable, certain ones are predefined and are listed in the Standard Elements appendix.

Constraints or tagged values associated with a particular stereotype are used to extend the semantics of model elements classified by that stereotype. The constraints must be observed by all model elements marked with that stereotype.

The following sections describe the abstract syntax, well-formedness rules, and semantics of the Extension Mechanisms package.

2.6.2 Abstract Syntax

The abstract syntax for the Extension Mechanisms package is expressed in graphic notation in Figure 2-10 on page 2-67.

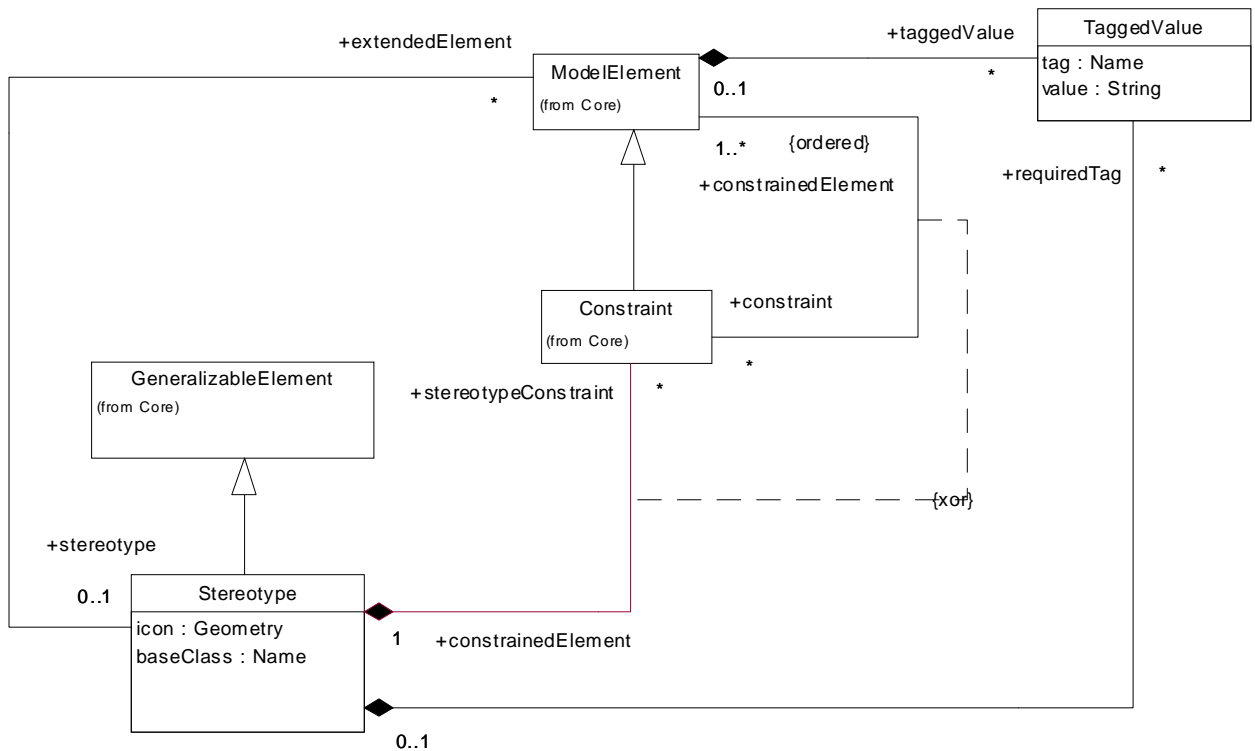

Figure 2-10 Extension Mechanisms

Constraint

The constraint concept allows new semantics to be specified linguistically for a model element. The specification is written as an expression in a designated constraint language. The language can be specially designed for writing constraints (such as OCL), a programming language, mathematical notation, or natural language. If constraints are to be enforced by a model editor tool, then the tool must understand the syntax and semantics of the constraint language. Because the choice of language is arbitrary, constraints are an extension mechanism.

In the metamodel a Constraint directly attached to a ModelElement describes semantic restrictions that this ModelElement must obey. Also, any Constraints attached to a Stereotype apply to each ModelElement that bears the given Stereotype.

2 UML Semantics

Attributes

<i>body</i>	A boolean expression defining the constraint. Expressions are written as strings in a designated language. For the model to be well formed, the expression must always yield a true value when evaluated for instances of the constrained elements at any time when the system is stable (i.e., not during the execution of an atomic operation).
-------------	---

Associations

<i>constrainedElement</i>	An ordered list of elements subject to the constraint. The constraint applies to their instances. If the element is a stereotype, then the constraint applies to the elements classified using it.
---------------------------	--

ModelElement (as extended)

Any model element may have arbitrary tagged values and constraints (subject to these making sense). A model element may have at most one stereotype whose base class must match the UML class of the modeling element (such as Class, Association, Dependency, etc.). The presence of a stereotype may impose implicit constraints on the modeling element and may require the presence of specific tagged values.

Associations

<i>constraint</i>	A constraint that must be satisfied for instances of the model element. A model element may have a set of constraints. The constraint is to be evaluated when the system is stable (i.e., not in the middle of an atomic operation).
<i>stereotype</i>	Designates at most one stereotype that further qualifies the UML class (the base class) of the modeling element. The stereotype does not alter the structure of the base class but it may specify additional constraints and tagged values. All constraints and tagged values on a stereotype apply to the model elements that are classified by the stereotype. The stereotype acts as a "pseudo metaclass" describing the model element.
<i>taggedValue</i>	An arbitrary property attached to the model element. The tag is the name of the property and the value is an arbitrary value. The interpretation of the tagged value is outside the scope of the UML metamodel. A model element may have a set of tagged values, but a single model element may have at most one tagged value with a given tag name. If the model element has a stereotype, then it may specify that certain tags must be present, providing default values.

Stereotype

The stereotype concept provides a way of classifying (marking) elements so that they behave in some respects as if they were instances of new "virtual" metamodel constructs. Instances have the same structure (attributes, associations, operations) as a similar non-stereotyped instance of the same kind. The stereotype may specify additional constraints and required tagged values that apply to instances. In addition, a stereotype may be used to indicate a difference in meaning or usage between two elements with identical structure.

In the metamodel the Stereotype metaclass is a subtype of GeneralizableElement. TaggedValues and Constraints attached to a Stereotype apply to all ModelElements classified by that Stereotype. A stereotype may also specify a geometrical icon to be used for presenting elements with the stereotype.

Stereotypes are GeneralizableElements. If a stereotype is a subtype of another stereotype, then it inherits all of the constraints and tagged values from its stereotype supertype and it must apply to the same kind of base class. A stereotype keeps track of the base class to which it may be applied.

Attributes

<i>baseClass</i>	Specifies the name of a UML modeling element to which the stereotype applies, such as Class, Association, Refinement, Constraint, etc. This is the name of a metaclass, that is, a class from the UML metamodel itself rather than a user model class.
<i>icon</i>	The geometrical description for an icon to be used to present an image of a model element classified by the stereotype.

Associations

<i>extendedElement</i>	Designates the model elements affected by the stereotype. Each one must be a model element of the kind specified by the baseClass attribute.
<i>constraint</i>	(Inherited from ModelElement) Designates constraints that apply to the stereotype itself.
<i>requiredTag</i>	Specifies a set of tagged values, each of which specifies a tag that an element classified by the stereotype is required to have. The value part indicates the default value for the tagged value, that is, the tagged value that an element will be presumed to have if it is not overridden by an explicit tagged value on the element bearing the stereotype. If the value is unspecified, then the element must explicitly specify a tagged value with the given tag.
<i>stereotypeConstraint</i>	Designates constraints that apply to elements bearing the stereotype.

2 UML Semantics

TaggedValue

A tagged value is a (Tag, Value) pair that permits arbitrary information to be attached to any model element. A tag is an arbitrary name, some tag names are predefined as Standard Elements. At most, one tagged value pair with a given tag name may be attached to a given model element. In other words, there is a lookup table of values selected by tag strings that may be attached to any model element.

The interpretation of a tag is (intentionally) beyond the scope of UML, it must be determined by user or tool convention. It is expected that various model analysis tools will define tags to supply information needed for their operation beyond the basic semantics of UML. Such information could include code generation options, model management information, or user-specified additional semantics.

Attributes

<i>tag</i>	A name that indicates an extensible property to be attached to ModelElements. There is a single, flat space of tag names. UML does not define a mechanism for name registry but model editing tools are expected to provide this kind of service. A model element may have at most one tagged value with a given name. A tag is, in effect, a pseudoattribute that may be attached to model elements.
<i>value</i>	An arbitrary value. The value must be expressible as a string for uniform manipulation. The range of permissible values depends on the interpretation applied to the tag by the user or tool; its specification is outside the scope of UML.

Associations

<i>modelElement</i>	A model element that the tag belongs to
<i>stereotype</i>	A tag that applies to elements bearing the stereotype.

2.6.3 Well-Formedness Rules

The following well-formedness rules apply to the Extension Mechanisms package.

Constraint

- [1] A Constraint attached to a Stereotype must not conflict with Constraints on any inherited Stereotype, or associated with the baseClass.
-- cannot be specified with OCL
- [2] A Constraint attached to a stereotyped ModelElement must not conflict with any constraints on the attached classifying Stereotype, nor with the Class (the baseClass) of the ModelElement.
-- cannot be specified with OCL

- [3] A Constraint attached to a Stereotype will apply to all ModelElements classified by that Stereotype and must not conflict with any constraints on the attached classifying Stereotype, nor with the Class (the baseClass) of the ModelElement.

```
-- cannot be specified with OCL
```

Stereotype

- [1] Stereotype names must not clash with any baseClass names.

```
Stereotype.oclAllInstances->forall(st | st.baseClass <> self.name)
```

- [2] Stereotype names must not clash with the names of any inherited Stereotype.

```
self.allSupertypes->forall(st : Stereotype | st.name <> self.name)
```

- [3] Stereotype names must not clash in the (M2) meta-class namespace, nor with the names of any inherited Stereotype, nor with any baseClass names.

```
-- M2 level not accessible
```

- [4] The baseClass name must be provided; icon is optional and is specified in an implementation specific way.

```
self.baseClass <> ''
```

- [5] Tag names attached to a Stereotype must not clash with M2 meta-attribute namespace of the appropriate baseClass element, nor with Tag names of any inherited Stereotype.

```
-- M2 level not accessible
```

ModelElement

- [1] Tags associated with a ModelElement (directly via a property list or indirectly via a Stereotype) must not clash with any metaattributes associated with the Model Element.

```
-- not specified in OCL
```

- [2] A model element must have at most one tagged value with a given tag name.

```
self.taggedValue->forall(t1, t2 : TaggedValue |  
    t1.tag = t2.tag implies t1 = t2)
```

- [3] (Required tags because of stereotypes) If T in modelElement.stereotype.require Tag such that T.value = unspecified, then the modelElement must have a tagged value with name = T.name.

```
self.stereotype.requiredTag->forall(tag |  
    tag.value = Undefined implies self.taggedValue->exists(t |  
        t.tag = tag.tag))
```

TaggedValue

No extra well-formedness rules.

2.6.4 Semantics

Constraints, stereotypes, and tagged values apply to model elements, not to instances. They represent extensions to the modeling language itself, not extensions to the run-time environment. They affect the structure and semantics of models. These concepts represent metalevel extensions to UML. However, they do not contain the full power of a heavyweight metamodel extension language and they are designed such that tools need not implement metalevel semantics to implement them.

Within a model, any user-level model element may have a set of constraints and a set of tagged values. The constraints specify restrictions on the instantiation of the model. An instance of a user-level model element must satisfy all of the constraints on its model element for the model to be well-formed. Evaluation of constraints is to be performed when the system is "stable," that is, after the completion of any internal operations when it is waiting for external events. Constraints are written in a designated constraint language, such as OCL, C++, or natural language. The interpretation of the constraints must be specified by the constraint language.

A user-level model element may have at most one tagged value with a given tag name. Each tag name represents a user-defined property applicable to model elements with a unique value for any single model element. The meaning of a tag is outside the scope of UML and must be determined by convention among users and model analysis tools.

It is intended that both constraints and tagged values be represented as strings so that they can be edited, stored, and transferred by tools that may not understand their semantics. The idea is that the understanding of the semantics can be localized into a few modules that make use of the values. For example, a code generator could use tagged values to tailor the code generation process and a process planning tool could use tagged values to denote model element ownership and status. Other modules would simply preserve the uninterpreted values (as strings) unchanged.

A stereotype refers to a `baseClass`, which is a class in the UML metamodel (not a user-level modeling element) such as `Class`, `Association`, `Refinement`, etc. A stereotype may be a subtype of one or more existing stereotypes (which must all refer the same `baseClass`, or `baseClasses` that derive from the same `baseClass`), in which case it inherits their constraints and required tags and may add additional ones of its own. As appropriate, a stereotype may add new constraints, a new icon for visual display, and a list of default tagged values.

If a user-level model element is classified by an attached stereotype, then the UML base class of the model element must match the base class specified by the stereotype. Any constraints on the stereotype are implicitly attached to the model element. Any tagged values on the stereotype are implicitly attached to the model element. If any of the values are unspecified, then the model element must explicitly define tagged values with the same tag name or the model is ill-formed. (This behaves as if a copy of the tagged values from the stereotype is attached to the model element, so that the default values can be changed). If the stereotype is a subtype of one or more other stereotypes, then any constraints or tagged values from those stereotypes also

apply to the model element (because they are inherited by this stereotype). If there are any conflicts among multiple constraints or tagged values (inherited or directly specified), then the model is ill-formed.

2.6.5 *Notes*

From an implementation point of view, instances of a stereotyped class are stored as instances of the base class with the stereotype name as a property. Tagged values can and should be implemented as a lookup table (qualified association) of values (expressed as strings) selected by tag names (represented as strings).

Attributes of UML metamodel classes and tag names should be accessible using a single uniform string-based selection mechanism. This allows tags to be treated as pseudo-attributes of the metamodel and stereotypes to be treated as pseudo-classes of the metamodel, permitting a smooth transition to a full metamodeling capability, if desired. See Section 5.2, “Mapping of UML Semantics to Facility Interfaces” for a discussion of the relationship of the UML to the OMG Meta Object Facility (MOF).

2 *UML Semantics*

2.7 Data Types

2.7.1 Overview

The Data Types package is the subpackage that specifies the different data types that are used to define UML. This chapter has a simpler structure than the other packages, since it is assumed that the semantics of these basic concepts are well known.

2.7.2 Abstract Syntax

The abstract syntax for the Data Types package is expressed in graphic notation in Figure 2-11 on page 2-75 and Figure 2-12 on page 2-76.

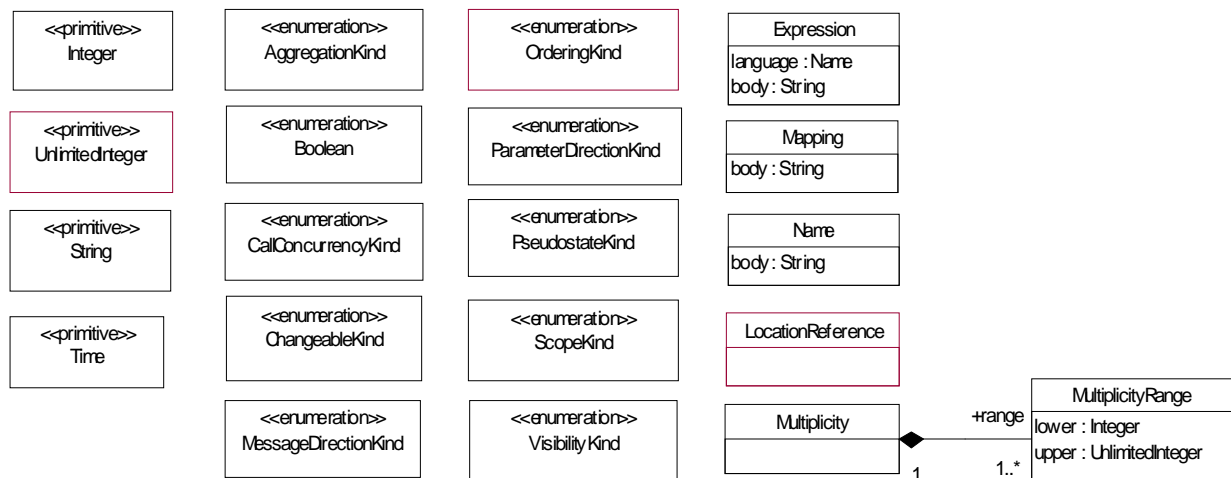

Figure 2-11 Data Types Package - Main

2 UML Semantics

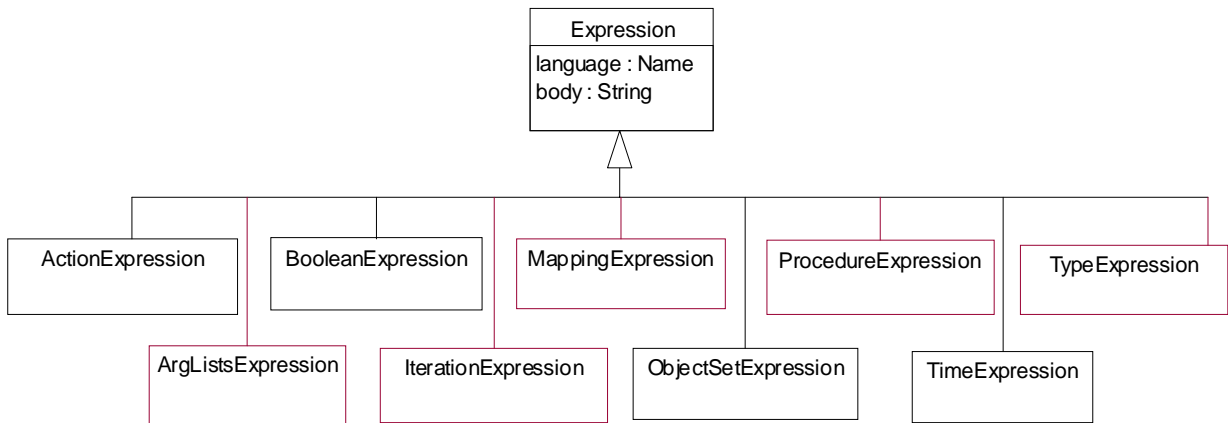

Figure 2-12 Data Types Package - Expressions

In the metamodel the data types are used for declaring the types of the classes' attributes. They appear as strings in the diagrams and not with a separate 'data type' icon. In this way, the sizes of the diagrams are reduced. However, each occurrence of a particular name of a data type denotes the same data type.

Note that these data types are the data types used for defining UML and not the data types to be used by a user of UML. The latter data types will be instances of the `DataType` metaclass defined in the metamodel.

ActionExpression

An expression that whose evaluation results in the performance of an action.

AggregationKind

An enumeration that denotes what kind of aggregation an Association is. When placed on a target end, specifies the relationship of the target end to the source end. `AggregationKind` defines an enumeration whose values are:

<code>none</code>	The end is not an aggregate.
<code>aggregate</code>	The end is an aggregate; therefore, the other end is a part and must have the aggregation value of none. The part may be contained in other aggregates.
<code>composite</code>	The end is a composite; therefore, the other end is a part and must have the aggregation value of none. The part is strongly owned by the composite and may not be part of any other composite.

ArgListsExpression

In the metamodel *ArgListsExpression* defines a statement which will result in a set of object lists when it is evaluated.

Boolean

In the metamodel, *Boolean* defines an enumeration that denotes a logical condition. Its values are:

<i>true</i>	The Boolean condition is satisfied.
<i>false</i>	The Boolean condition is not satisfied.

BooleanExpression

In the metamodel *BooleanExpression* defines a statement which will evaluate to an instance of *Boolean* when it is evaluated.

CallConcurrencyKind

An enumeration that denotes the semantics of multiple concurrent calls to the same passive instance (i.e., an *Instance* originating from a *Classifier* with *isActive=false*). It is an enumeration with the values:

<i>sequential</i>	Callers must coordinate so that only one call to an <i>Instance</i> (on any sequential <i>Operation</i>) may be outstanding at once. If simultaneous calls occur, then the semantics and integrity of the system cannot be guaranteed.
<i>guarded</i>	Multiple calls from concurrent threads may occur simultaneously to one <i>Instance</i> (on any guarded <i>Operation</i>), but only one is allowed to commence. The others are blocked until the performance of the first <i>Operation</i> is complete. It is the responsibility of the system designer to ensure that deadlocks do not occur due to simultaneous blocks. Guarded <i>Operations</i> must perform correctly (or block themselves) in the case of a simultaneous sequential <i>Operation</i> or guarded semantics cannot be claimed.
<i>concurrent</i>	Multiple calls from concurrent threads may occur simultaneously to one <i>Instance</i> (on any concurrent <i>Operation</i>). All of them may proceed concurrently with correct semantics. Concurrent <i>Operations</i> must perform correctly in the case of a simultaneous sequential or guarded <i>Operation</i> or concurrent semantics cannot be claimed.

2 UML Semantics

ChangeableKind

In the metamodel *ChangeableKind* defines an enumeration that denotes how an *AttributeLink* or *LinkEnd* may be modified. Its values are:

<i>changeable</i>	No restrictions on modification.
<i>frozen</i>	The value may not be changed from the source end after the creation and initialization of the source object. Operations on the other end may change a value.
<i>addOnly</i>	If the multiplicity is not fixed, values may be added at any time from the source object, but once created a value may not be removed from the source end. Operations on the other end may change a value.

Expression

In the metamodel an *Expression* defines a statement which will evaluate to a (possibly empty) set of instances when executed in a context. An *Expression* does not modify the environment in which it is evaluated. An expression contains an expression string and the name of an interpretation language with which to evaluate the string.

Attributes

<i>language</i>	Names the language in which the expression body is represented. The interpretation of the expression depends on the language. If the language name is omitted, no interpretation for the expression can be assumed by UML.
<i>body</i>	The text of the expression expressed in the given language.

Predefined language names include the following:

OCL	The Object Constraint Language (see Chapter 7, "Object Constraint Language Specification").
-----	---

Geometry

An uninterpreted type used to describe the geometrical shape of icons, such as those that may be attached to stereotypes. The details of this specification are not currently part of UML and must therefore be supplied by the implementation of a model editing tool, with the understanding that they will likely be tool-specific. This type is therefore not actually defined in the metamodel but is used only as the type of attributes.

Integer

In the metamodel an *Integer* is an element in the (infinite) set of integers (...-2, -1, 0, 1, 2...).

IterationExpression

In the metamodel *IterationExpression* defines a string which will evaluate to a iteration control construct in the interpretation language.

LocationReference

Designates a position within a behavior sequences for the insertion of an extension use case. May be a line or range of lines in code, or a state or set of states in a state machine, or some other means in a different kind of specification.

Mapping

In the metamodel a *Mapping* is an expression that is used for mapping *ModelElements*. For exchange purposes, it should be represented as a *String*.

Attributes

<i>body</i>	A string describing the mapping. The format of the mapping is currently unspecified in UML.
-------------	---

MappingExpression

An expression that evaluates to a mapping.

MessageDirectionKind

This enumeration type is no longer used in UML.

Multiplicity

In the metamodel a *Multiplicity* defines a non-empty set of non-negative integers. A set which only contains zero (`{0}`) is not considered a valid *Multiplicity*. Every *Multiplicity* has at least one corresponding *String* representation.

MultiplicityRange

In the metamodel a *MultiplicityRange* defines a range of integers. The upper bound of the range cannot be below the lower bound. The lower bound must be a nonnegative integer. The upper bound must be a nonnegative integer or the special value *unlimited*, which indicates there is no upper bound on the range.

Name

In the metamodel a *Name* defines a token which is used for naming *ModelElements*. Each *Name* has a corresponding *String* representation. For purposes of exchange a name should be represented as a *String*.

2 UML Semantics

Attributes

body The name string.

ObjectSetExpression

In the metamodel *ObjectSetExpression* defines a statement which will evaluate to a set of instances when it is evaluated. *ObjectSetExpressions* are commonly used to designate the target instances in an Action. The expression may be the reserved word “all” when used as the target of a *SendAction*. It evaluates to all the instances that can receive the signal, as determined by the underlying runtime system.

OrderingKind

Defines an enumeration that specifies how the elements of a set are arranged. Used in conjunction with elements that have a multiplicity in cases when the multiplicity value is greater than one. The ordering must be determined and maintained by operations that modify the set. The intent is that the set of enumeration literals be open for new values to be added by tools for purposes of design, code generation, etc. For example, a value of sorted might be used for a design specification. Values are:

<i>unordered</i>	The elements of the set have no inherent ordering.
<i>ordered</i>	The elements of the set have a sequential ordering.

Other possibilities (such as sorted) may be defined later by declaring additional keywords. As with user-defined stereotypes, this would be a private extension supported by particular editing tools.

ParameterDirectionKind

In the metamodel *ParameterDirectionKind* defines an enumeration that denotes if a *Parameter* is used for supplying an argument and/or for returning a value. The enumeration values are:

<i>in</i>	An input <i>Parameter</i> (may not be modified).
<i>out</i>	An output <i>Parameter</i> (may be modified to communicate information to the caller).
<i>inout</i>	An input <i>Parameter</i> that may be modified.
<i>return</i>	A return value of a call.

ProcedureExpression

In the metamodel *ProcedureExpression* defines a statement which will result in a change to the values of its environment when it is evaluated.

PseudostateKind

In the metamodel, *PseudostateKind* defines an enumeration that discriminates the kind of *Pseudostate*. See “*PseudoState*” on page 2-134 for details. The enumeration values are:

choice	Splits an incoming transition into several disjoint outgoing transition. Each outgoing transition has a guard condition that is evaluated after prior actions on the incoming path have been completed. At least one outgoing transition must be enabled or the model is ill-formed.
deepHistory	When reached as the target of a transition, restores the full state configuration that was active just before the enclosing composite state was last exited.
fork	Splits an incoming transition into several concurrent outgoing transitions. All of the transitions fire together.
initial	The default target of a transition to the enclosing composite state.
join	Merges transitions from concurrent regions into a single outgoing transition. All the transitions fire together.
junction	Chains together transitions into a single run-to-completion path. May have multiple input and/or output transitions. Each complete path involving a junction is logically independent and only one such path fires at one time. May be used to construct branches and merges.
shallowHistory	When reached as the target of a transition, restores the state within the enclosing composite state that was active just before the enclosing state was last exited. Does not restore any substates of the last active state.

ScopeKind

In the metamodel *ScopeKind* defines an enumeration that denotes whether a feature belongs to individual instances or an entire classifier. Its values are:

instance	The feature pertains to Instances of a Classifier. For example, it is a distinct Attribute in each Instance or an Operation that works on an Instance.
classifier	The feature pertains to an entire Classifier. For example, it is an Attribute shared by the entire Classifier or an Operation that works on the Classifier, such as a creation operation.

String

In the metamodel a *String* defines a stream of text.

2 UML Semantics

Time

In the metamodel a Time defines a value representing an absolute or relative moment in time and space. A Time has a corresponding string representation.

TimeExpression

In the metamodel TimeExpression defines a statement which will evaluate to an instance of Time when it is evaluated.

TypeExpression

In the metamodel TypeExpression defines a string that is a programming language type in the interpretation language.

UnlimitedInteger

In the metamodel UnlimitedInteger defines a data type whose range is the nonnegative integers augmented by the special value “unlimited”. It is used for the upper bound of multiplicities.

Uninterpreted

In the metamodel an Uninterpreted is a blob, the meaning of which is domain-specific and therefore not defined in UML.

VisibilityKind

In the metamodel VisibilityKind defines an enumeration that denotes how the element to which it refers is seen outside the enclosing name space. Its values are:

public	Other elements may see and use the target element.
protected	Descendants of the source element may see and use the target element.
private	Only the source element may see and use the target element.

Part 3 - Behavioral Elements

This Behavioral Elements package is the language superstructure that specifies the dynamic behavior or models. The Behavioral Elements package is decomposed into the following subpackages: Common Behavior, Collaborations, Use Cases, State Machines, and Activity Graphs.

2.8 Behavioral Elements Package

Common Behavior specifies the core concepts required for behavioral elements. The Collaborations package specifies a behavioral context for using model elements to accomplish a particular task. The Use Case package specifies behavior using actors and use cases. The State Machines package defines behavior using finite-state transition systems. The Activity Graphs package defines a special case of a state machine that is used to model processes.

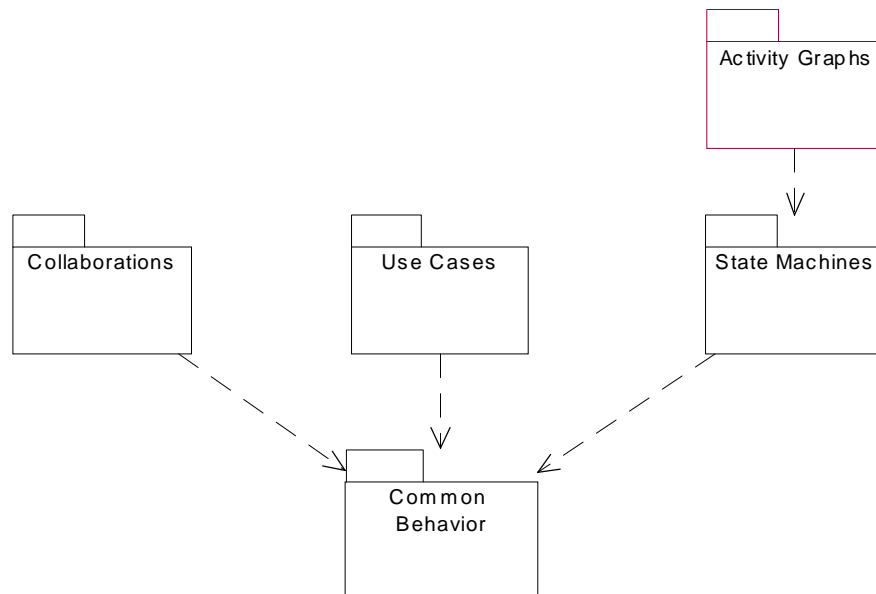

Figure 2-13 Behavioral Elements Package

2.9 Common Behavior

2.9.1 Overview

The Common Behavior package is the most fundamental of the subpackages that compose the Behavioral Elements package. It specifies the core concepts required for dynamic elements and provides the infrastructure to support Collaborations, State Machines and Use Cases.

The following sections describe the abstract syntax, well-formedness rules and semantics of the Common Behavior package.

2 UML Semantics

2.9.2 Abstract Syntax

The abstract syntax for the Common Behavior package is expressed in graphic notation in the following figures. Figure 2-14 on page 2-84 shows the model elements that define Signals and Receptions.

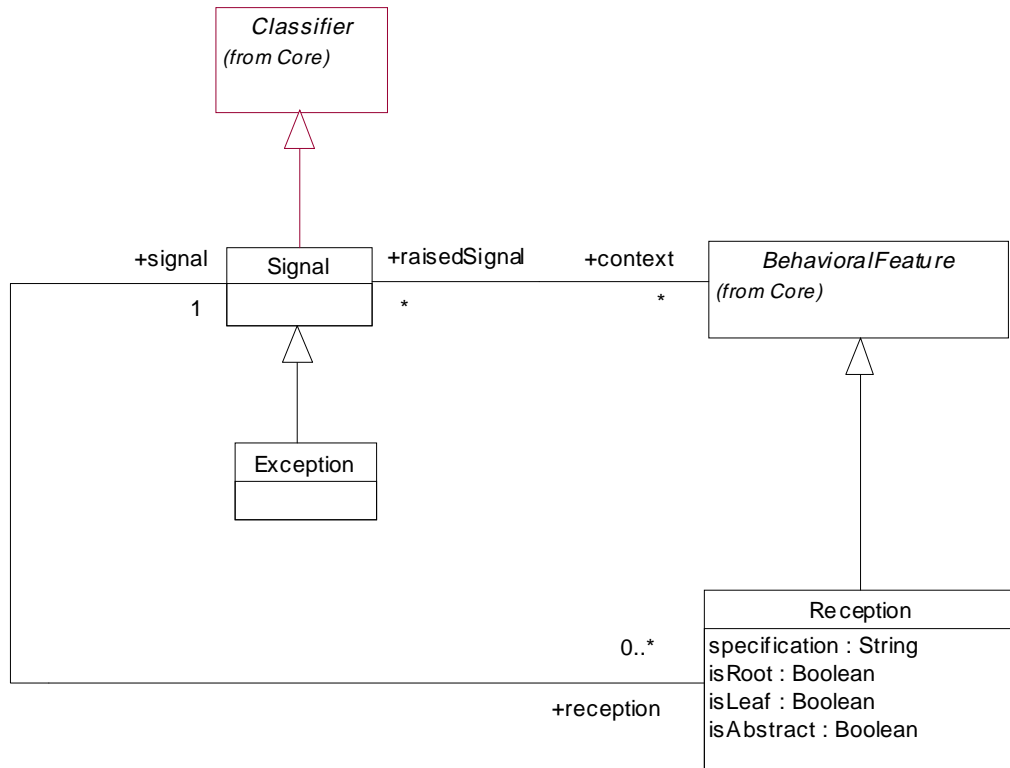

Figure 2-14 Common Behavior - Signals

Figure 2-15 on page 2-85 illustrates the model elements that specify various actions, such as CreateAction, CallAction and SendAction.

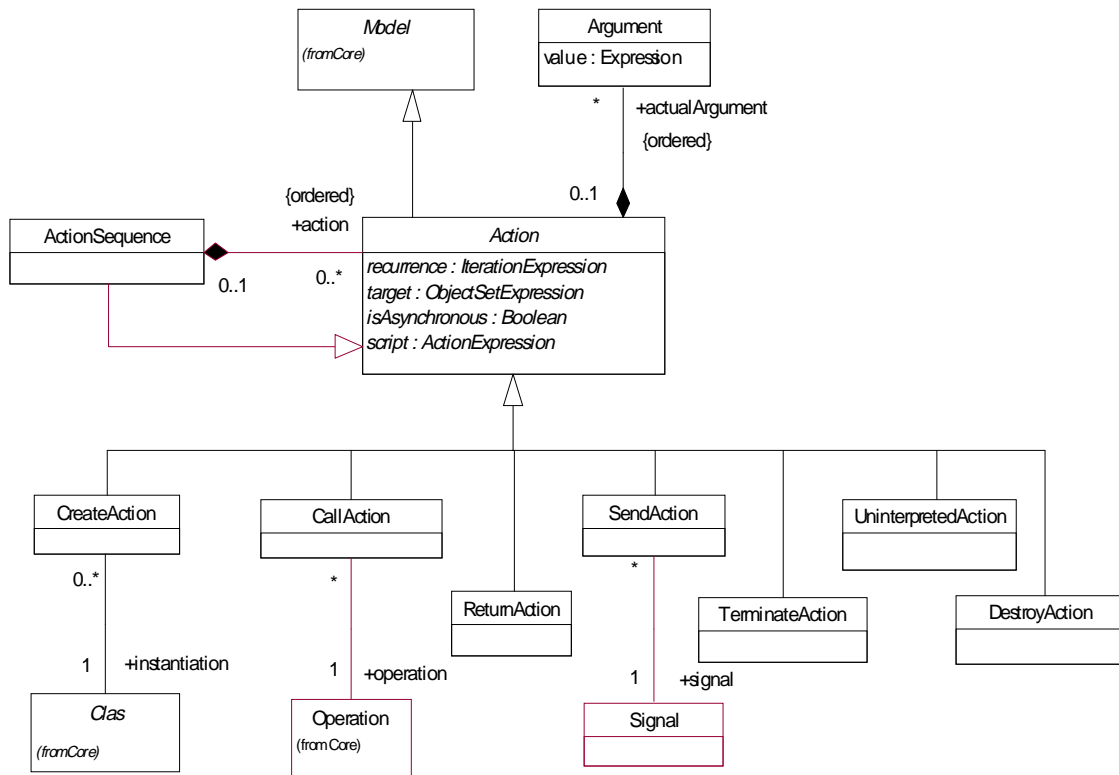

Figure 2-15 Common Behavior - Actions

Figure 2-16 on page 2-86 shows the model elements that define Instances and Links.

2 UML Semantics

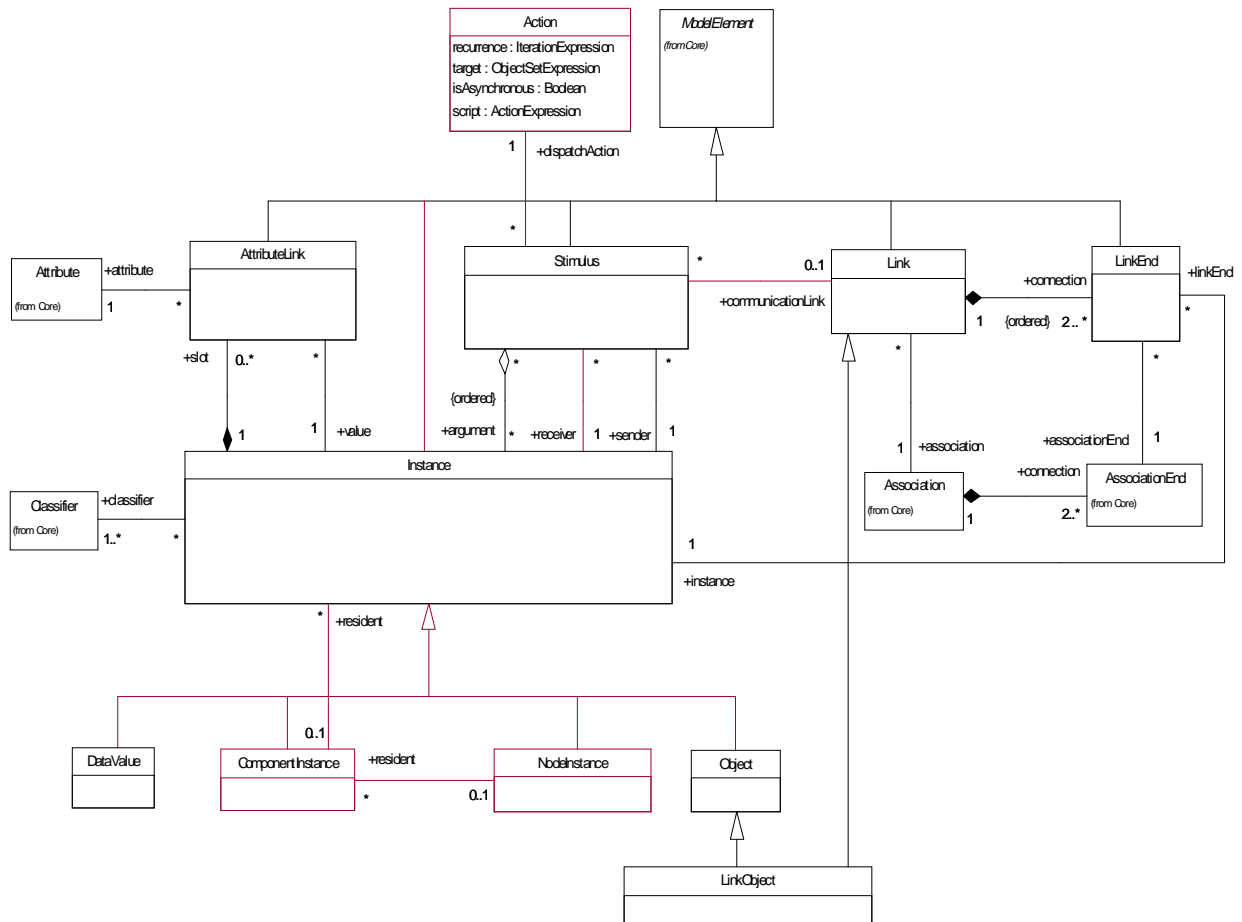

Figure 2-16 Common Behavior - Instances and Links

The following metaclasses are contained in the Common Behavior package.

Action

An action is a specification of an executable statement that forms an abstraction of a computational procedure that results in a change in the state of the model, and can be realized by sending a message to an object or modifying a link or a value of an attribute.

In the metamodel an Action may be part of an ActionSequence and may contain a specification of a target as well as a specification of the actual arguments, i.e. a list of Arguments containing expressions for determining the actual Instances to be used when the Action is performed (or executed).

The target metaattribute is of type ObjectSetExpression which, when executed, resolves into zero or more specific Instances that are the intended target of the Action, like a receiver of a dispatched Signal. The recurrence metaattribute specifies how the target set is iterated when the action is executed. It is not defined within UML if the action is applied sequentially or in parallel to the target instances.

Action is an abstract metaclass.

Attributes

<i>isAsynchronous</i>	Indicates if a dispatched Stimulus is asynchronous or not.
<i>recurrence</i>	An Expression stating how many times the Action should be performed.
<i>script</i>	An ActionExpression describing the effects of the Action.
<i>target</i>	An ObjectSetExpression which determines the target of the Action.

Associations

<i>actualArgument</i>	A sequence of Expressions which determines the actual arguments needed when evaluating the Action.
-----------------------	--

ActionSequence

An action sequence is a collection of actions.

In the metamodel an ActionSequence is an Action, which is an aggregation of other Actions. It describes the behavior of the owning State or Transition.

Associations

<i>action</i>	A sequence of Actions performed sequentially as an atomic unit.
---------------	---

Argument

An argument is an expression describing how to determine the actual values passed in a dispatched request. It is aggregated within an action.

In the metamodel an Argument is a part of an Action and contains a metaattribute, value, of type Expression. It states how the actual argument is determined when the owning Action is executed.

Attributes

<i>value</i>	An Expression determining the actual Instance when evaluated.
--------------	---

2 UML Semantics

AttributeLink

An attribute link is a named slot in an instance, which holds the value of an attribute.

In the metamodel *AttributeLink* is a piece of the state of an *Instance* and holds the value of an *Attribute*.

Associations

<i>value</i>	The Instance which is the value of the <i>AttributeLink</i> .
<i>attribute</i>	The <i>Attribute</i> from which the <i>AttributeLink</i> originates.

CallAction

A call action is an action resulting in an invocation of an operation on an instance. A call action can be synchronous or asynchronous, indicating whether the operation is invoked synchronously or asynchronously.

In the metamodel the *CallAction* is an *Action*. The designated *Instance* or set of *Instances* is specified via the target expression, and the actual arguments are designated via the argument association inherited from *Action*. The *Operation* to be invoked is specified by the associated *Operation*.

Attributes

<i>isAsynchronous</i>	(inherited from <i>Action</i>) Indicates if a dispatched operation is asynchronous or not. <ul style="list-style-type: none">• False - indicates that the caller waits for the completion of the execution of the operation.• True - Indicates that the caller does not wait for the completion of the execution of the operation but continues immediately.
-----------------------	--

Associations

<i>operation</i>	The operation which will be invoked when the <i>Action</i> is executed.
------------------	---

ComponentInstance

A component instance is an instance of a component that resides on a node instance. A component instance may have a state.

In the metamodel, a *ComponentInstance* is an *Instance* that originates from a *Component*. It may be associated with a set of *Instance*, and may reside on a *NodeInstance*.

Associations

<i>resident</i>	A collection of <i>Instances</i> that exist inside the <i>ComponentInstance</i> .
-----------------	---

CreateAction

A create action is an action resulting in the creation of an instance of some classifier.

In the metamodel the CreateAction is an Action. The Classifier to be instantiated is designated by the instantiation association of the CreateAction. A CreateAction has no target instance.

Associations

<i>instantiation</i>	The Classifier of which an Instance will be created of when the CreateAction is performed.
----------------------	--

DestroyAction

A destroy action is an action results in the destruction of an object specified in the action.

In the metamodel a DestroyAction is an Action. The designated object is specified by the target association of the Action.

DataValue

A data value is an instance with no identity.

In the metamodel DataValue is a child of Instance that cannot change its state, i.e. all Operations that are applicable to it are pure functions or queries. DataValues are typically used as attribute values.

Exception

An exception is a signal raised by behavioral features typically in case of execution faults.

In the metamodel, Exception is derived from Signal. An Exception is associated with the BehavioralFeatures that raise it.

Associations

<i>context</i>	(Inherited from Signal) The set of BehavioralFeatures that raise the exception.
----------------	---

Instance

The instance construct defines an entity to which a set of operations can be applied and which has a state that stores the effects of the operations.

In the metamodel Instance is connected to at least one Classifier which declares its structure and behavior. It has a set of attribute values and is connected to a set of Links, both sets matching the definitions of its Classifiers. The two sets implement the current state of the Instance. Instance is an abstract metaclass.

2 UML Semantics

Associations

<i>slot</i>	The set of AttributeLinks that holds the attribute values of the Instance.
<i>linkEnd</i>	The set of LinkEnds of the connected Links that are attached to the Instance.
<i>classifier</i>	The set of Classifiers that declare the structure of the Instance.

Standard Constraints

<i>destroyed</i>	Destroyed is a constraint applied to an instance, specifying that the instance is destroyed during the execution.
<i>new</i>	New is a constraint applied to an instance, specifying that the instance is created during the execution.
<i>transient</i>	Transient is a constraint applied to an instance, specifying that the instance is created and destroyed during the execution.

Tagged Values

<i>persistent</i>	Persistence denotes the permanence of the state of the instance, marking it as <i>transitory</i> (its state is destroyed when the instance is destroyed) or <i>persistent</i> (its state is not destroyed when the instance is destroyed).
-------------------	--

Link

The link construct is a connection between instances.

In the metamodel Link is an instance of an Association. It has a set of LinkEnds that matches the set of AssociationEnds of the Association. A Link defines a connection between Instances.

Associations

<i>association</i>	The Association that is the declaration of the link.
<i>connection</i>	The tuple of LinkEnds that constitute the Link.

Standard Constraints

destroyed	Destroyed is a constraint applied to a link, specifying that the link is destroyed during the execution.
new	New is a constraint applied to a link, specifying that the link is created during the execution.
transient	Transient is a constraint applied to a link, specifying that the link is created and destroyed during the execution.

LinkEnd

A link end is an end point of a link.

In the metamodel LinkEnd is the part of a Link that connects to an Instance. It corresponds to an AssociationEnd of the Link's Association.

Associations

<i>associationEnd</i>	The AssociationEnd that is the declaration of the LinkEnd..
<i>instance</i>	The Instance connected to the LinkEnd.
<i>qualifierValue</i>	The AttributeLinks that hold the values of the Qualifier associated with the corresponding AssociationEnd.

Stereotypes

association	Association is a constraint applied to a link-end, specifying that the corresponding instance is visible via association.
global	Global is a constraint applied to a link-end, specifying that the corresponding instance is visible because it is in a global scope relative to the link.
local	Local is a constraint applied to link-end, specifying that the corresponding instance is visible because it is in a local scope relative to the link.
parameter	Parameter is a constraint applied to a link-end, specifying that the corresponding instance is visible because it is a parameter relative to the link.
self	Self is a constraint applied to a link-end, specifying that the corresponding instance is visible because it is the dispatcher of a request.

LinkObject

A link object is a link with its own set of attribute values and to which a set of operations may be applied.

In the metamodel LinkObject is a connection between a set of Instances, where the connection itself may have a set of attribute values and to which a set of Operations may be applied. It is a child of both Object and Link.

NodeInstance

A node instance is an instance of a node. A collection of component instances may reside on the node instance.

In the metamodel *NodeInstance* is an *Instance* that originates from a *Node*. Each *ComponentInstance* that resides on a *NodeInstance* must be an instance of a *Component* that resides on the corresponding *Node*.

Associations

resident A collection of *ComponentInstances* that reside on the *NodeInstances*.

Object

An object is an instance that originates from a class.

In the metamodel *Object* is a subclass of *Instance* and it originates from at least one *Class*. The set of *Classes* may be modified dynamically, which means that the set of features of the *Object* may change during its life-time.

Reception

A reception is a declaration stating that a classifier is prepared to react to the receipt of a signal. The reception designates a signal and specifies the expected behavioral response. A reception is a summary of expected behavior. The details of handling a signal are specified by a state machine.

In the metamodel *Reception* is a child of *BehavioralFeature* and declares that the *Classifier* containing the feature reacts to the signal designated by the reception feature. The *isPolymorphic* attribute specifies whether the behavior is polymorphic or not; a true value indicates that the behavior is not always the same and may be affected by state or subclassing. The specification indicates the expected response to the *Signal*.

Attributes

<i>isAbstract</i>	If true, then the reception does not have an implementation, and one must be supplied by a descendant. If false, the reception must have an implementation in the classifier or inherited from an ancestor.
<i>isLeaf</i>	If true, then the implementation of the reception may not be overridden by a descendant classifier. If false, then the implementation of the reception may be overridden by a descendant classifier (but it need not be overridden).
<i>isRoot</i>	If true, then the classifier must not inherit a declaration of the same reception. If false, then the classifier may (but need not) inherit a declaration of the same reception. (But the declaration must match in any case; a classifier may not modify an inherited declaration of a reception.)
<i>specification</i>	A description of the effects of the classifier receiving a Signal, stated by a String.

Associations

<i>signal</i>	The Signal that the Classifier is prepared to handle.
---------------	---

ReturnAction

A return action is an action that results in returning a value to a caller.

In the metamodel ReturnAction is an Action, which causes values to be passed back to the activator. The values are represented by the arguments inherited from Action. A ReturnAction has no explicit target.

SendAction

A send action is an action that results in the (asynchronous) sending of a signal. The signal can be directed to a set of receivers via an objectSetExpression, or sent implicitly to an unspecified set of receivers, defined by some external mechanism. For example, if the signal is an exception, the receiver is determined by the underlying runtime system mechanisms.

In the metamodel SendAction is an Action. It is associated with the Signal to be raised, and its actual arguments are specified by the argument association, inherited from Action.

Associations

<i>signal</i>	The signal which will be invoked when the Action is executed.
---------------	---

2 UML Semantics

Signal

A signal is a specification of an asynchronous stimulus communicated between instances. The receiving instance handles the signal by a state machine. Signal is a generalizable element and is defined independently of the classes handling the signal. A reception is a declaration that a class handles a signal, but the actual handling is specified by a state machine.

In the metamodel Signal is a child to Classifier, with the parameters expressed as Attributes. A Signal is always asynchronous. A Signal is associated with the BehavioralFeatures that raise it.

Associations

<i>context</i>	The set of BehavioralFeatures that raise the signal.
<i>reception</i>	A set of Receptions that indicates Classes prepared to handle the signal.

Stimulus

A stimulus reifies a communication between two instances.

In the metamodel Stimulus is a communication, i.e. a Signal sent to an Instance, or an invocation of an Operation. It can also be a request to create an Instance, or to destroy an Instance. It has a sender, a receiver, and may have a set of actual arguments, all being Instances.

Associations

<i>argument</i>	The sequence of Instances being the arguments of the MessageInstance.
<i>communicationLink</i>	The Link, which is used for communication.
<i>dispatchAction</i>	The Action which caused the Stimulus to be dispatched when it was executed.
<i>receiver</i>	The Instance which receives the Stimulus.
<i>sender</i>	The Instance which sends the Stimulus.

TerminateAction

A terminate action results in self-destruction of an object.

In the metamodel TerminateAction is a child of Action. The target of a TerminateAction is implicitly the Instance executing the action, so there is no explicit target.

UninterpretedAction

An uninterpreted action represents an action that is not explicitly reified in the UML

Taken to the extreme, any action is a call or raise on some instance, like in Smalltalk. However, in more practical terms, uninterpreted actions can be used to model language-specific actions that are neither call actions nor send actions, and are not easily categorized under the other types of actions.

2.9.3 Well-Formedness Rules

The following well-formedness rules apply to the Common Behavior package.

Action

No extra well-formedness rules.

ActionSequence

No extra well-formedness rules.

Argument

No extra well-formedness rules.

AssignmentAction

No extra well-formedness rules.

AttributeLink

[1] The type of the Instance must match the type of the Attribute.

```
self.value.classifier->union (  
    self.value.classifier.allParents)->includes (  
    self.attribute.type)
```

CallAction

[1] The number of arguments be the same as the number of the Operation.

```
self.actualArgument->size = self.operation.parameter->size
```

ComponentInstance

[1] A ComponentInstance originates from exactly one Component.

```
self.classifier->size = 1  
and  
self.classifier.oclIsKindOf (Component)
```

2 UML Semantics

CreateAction

- [1] A CreateAction does not have a target expression.

```
self.target->isEmpty
```

DestroyAction

- [1] A DestroyAction should not have arguments

```
self.actualArgument->size = 0
```

DataValue

- [1] A DataValue originates from exactly one Classifier, which is a DataType.

```
(self.classifier->size = 1)
```

and

```
self.classifier.ocIsKindOf(DataType)
```

- [2] A DataValue has no AttributeLinks.

```
self.slot->isEmpty
```

Exception

No extra well-formedness rules.

Instance

- [1] The AttributeLinks match the declarations in the Classifiers.

```
self.slot->forall ( al |
  self.classifier->exists ( c |
    c.allAttributes->includes ( al.attribute ) ) )
```

- [2] The Links matches the declarations in the Classifiers.

```
self.allLinks->forall ( l |
  self.classifier->exists ( c |
    c.allAssociations->includes ( l.association ) ) )
```

- [3] If two Operations have the same signature they must be the same.

```
self.classifier->forall ( c1, c2 |
  c1.allOperations->forall ( op1 |
    c2.allOperations->forall ( op2 |
      op1.hasSameSignature (op2) implies op1 = op2 ) ) )
```

- [3] There are no name conflicts between the AttributeLinks and opposite LinkEnds.

```
self.slot->forall( al |
  not self.allOppositeLinkEnds->exists( le | le.name = al.name ) )
and
```

```
self.allOppositeLinkEnds->forall( le |
    not self.slot->exists( al | le.name = al.name ) )
```

[4] For each Association in which an Instance is involved, the number of opposite LinkEnds must match the multiplicity of the AssociationEnd.

```
self.classifier.allOppositeAssociationEnds->forall ( ae |
    ae.multiplicity.multiplicityRange->exists ( mr |
        self.selectedLinkEnds (ae)->size >= mr.lower and
        (mr.upper = 'unlimited' or
         (mr.upper <> 'unlimited' and
          self.selectedLinkEnds (ae)->size <=
           mr.upper.oclAsType (Integer) ) ) ) )
```

[5] The number of associated AttributeLinks must match the multiplicity of the Attribute.

```
self.classifier.allAttributes->forall ( a |
    a.multiplicity.multiplicityRange->exists ( mr |
        self.selectedAttributeLinks (a)->size >= mr.lower and
        (mr.upper = 'unlimited' or
         (mr.upper <> 'unlimited' and
          self.selectedLinkEnds (a)->size <=
           mr.upper.oclAsType (Integer) ) ) ) )
```

Additional operations

[1] The operation allLinks results in a set containing all Links of the Instance itself.

```
allLinks : set(Link);
allLinks = self.linkEnd.link
```

[2] The operation allOppositeLinkEnds results in a set containing all LinkEnds of Links connected to the Instance with another LinkEnd.

```
allOppositeLinkEnds : set(LinkEnd);
allOppositeLinkEnds = self.allLinks.connection->select (le |
    le.instance <> self)
```

[3] The operation selectedLinkEnds results in a set containing all opposite LinkEnds corresponding to a given AssociationEnd.

```
selectedLinkEnds (ae : AssociationEnd) : set(LinkEnd);
selectedLinkEnds (ae) = self.allOppositeLinkEnds->select (le |
    le.associationEnd = ae)
```

[4] The operation selectedAttributeLinks results in a set containing all AttributeLinks corresponding to a given Attribute.

```
selectedAttributeLinks (ae : Attribute) : set(AttributeLink);
selectedAttributeLinks (a) = self.slot->select (s |
    s.attribute = a)
```

2 UML Semantics

Link

- [1] The set of LinkEnds must match the set of AssociationEnds of the Association.

```
Sequence {1..self.connection->size}->forall ( i |
    self.connection->at ( i ).associationEnd =
    self.association.connection->at ( i ) )
```

- [2] There are not two Links of the same Association which connects the same set of Instances in the same way.

```
self.association.link->forall ( l |
    Sequence {1..self.connection->size}->forall ( i |
        self.connection->at ( i ).instance =
        l.connection->at ( i ).instance )
        implies self = l )
```

LinkEnd

- [1] The type of the Instance must match the type of the AssociationEnd.

```
self.instance.classifier->union (
    self.instance.classifier.allParents)->includes (
    self.associationEnd.type)
```

LinkObject

- [1] One of the Classifiers must be the same as the Association.

```
self.classifier->includes(self.association)
```

- [2] The Association must be a kind of AssociationClass.

```
self.association.oclIsKindOf(AssociationClass)
```

NodeInstance

- [1] A NodeInstance must have only one Classifier as its origin, and it must be a Node.

```
self.classifier->forall ( c | c.oclIsKindOf(Node))
and
self.classifier->size = 1
```

- [2] Each ComponentInstance that resides on a NodeInstance must be an instance of a Component that resides on the corresponding Node.

```
self.resident->forall(n |
    self.classifier.resident->includes(n.classifier))
```

Object

- [1] Each of the Classifiers must be a kind of Class.

```
self.classifier->forall ( c | c.oclIsKindOf(Class))
```

Reception

- [1] A Reception can not be a query.

```
not self.isQuery
```

ReturnAction

No extra well-formedness rules.

SendAction

- [1] The number of arguments is the same as the number of parameters of the Signal.

```
self.actualArgument->size = self.signal.allAttributes->size
```

- [2] A Signal is always asynchronous.

```
self.isAsynchronous
```

Signal

No extra well-formedness rules.

Stimulus

- [1] The number of arguments must match the number of Arguments of the Action.

```
self.dispatchAction.actualArgument->size = self.argument->size
```

- [2] The Action must be a SendAction, a CallAction, a CreateAction, or a DestroyAction.

```
self.dispatchAction.ocIsKindOf (SendAction) or  
self.dispatchAction.ocIsKindOf (CallAction) or  
self.dispatchAction.ocIsKindOf (CreateAction) or  
self.dispatchAction.ocIsKindOf (DestroyAction)
```

TerminateAction

- [1] A TerminateAction has no arguments.

```
self.actualArguments->size = 0
```

- [2] A TerminateAction has no target expression.

```
self.target->isEmpty
```

UninterpretedAction

No extra well-formedness rules.

2 UML Semantics

2.9.4 Semantics

This section provides a description of the semantics of the elements in the Common Behavior package.

Object and DataValue

An object is an instance that originates from a class, it is structured and behaves according to its class. All objects originating from the same class are structured in the same way, although each of them has its own set of attribute links. Each attribute link references an instance, usually a data value. The number of attribute links with the same name fulfills the multiplicity of the corresponding attribute in the class. The set may be modified according to the specification in the corresponding attribute, e.g. each referenced instance must originate from (a specialization of) the type of the attribute, and attribute links may be added or removed according to the changeable property of the attribute.

An object may have multiple classes (i.e., it may originate from several classes). In this case, the object will have all the features declared in all of these classes, both the structural and the behavioral ones. Moreover, the set of classes (i.e., the set of features that the object conforms to) may vary over time. New classes may be added to the object and old ones may be detached. This means that the features of the new classes are dynamically added to the object, and the features declared in a class which is removed from the object are dynamically removed from the object. No name clashes between attributes links and opposite link ends are allowed, and each operation which is applicable to the object should have a unique signature.

Another kind of instance is data value, which is an instance with no identity. Moreover, a data value cannot change its state; all operations that are applicable to a data value are queries and do not cause any side effects. Since it is not possible to differentiate between two data values that appear to be the same, it becomes more of a philosophical issue whether there are several data values representing the same value or just one for each value-it is not possible to tell. In addition, a data value cannot change its data type.

Link

A link is a connection between instances. Each link is an instance of an association, i.e. a link connects instances of (specializations of) the associated classifiers. In the context of an instance, an opposite end defines the set of instances connected to the instance via links of the same association and each instance is attached to its link via a link-end originating from the same association-end. However, to be able to use a particular opposite end, the corresponding link end attached to the instance must be navigable. An instance may use its opposite ends to access the associated instances. An instance can communicate with the instances of its opposite ends and also use references to them as arguments or reply values in communications.

A link object is a special kind of link, it is at the same time also an object. Since an object may change its classes this is also true for a link object. However, one of the classes must always be an association class.

Signal, Exception and Stimulus

Several kinds of requests exist between instances, e.g. sending a signal and invoking an operation. The former is used to trigger a reaction in the receiver in an asynchronous way and without a reply, while the latter is applied to an instance, which can be either done synchronously or asynchronously and may require a reply from the receiver to the sender. Other kinds of requests are: create a new instance, or deleting an already existing instance. When an instance communicates with another instance a stimulus is passed between the two instances. Each stimulus has a sender instance and a receiver instance, and possibly a sequence of arguments according to the specifying signal or operation. The stimulus uses a link between the sender and the receiver for communication. This link may be missing if the receiver is an argument inside the current activation, a local or global variable, or if the stimulus is sent to the sender instance, itself. Moreover, a stimulus is dispatched by an action, e.g. a call action or a send action. The action specifies the request made by the stimulus, like the operation to be invoked or the signal event to be raised, as well as how the actual arguments of the stimulus are determined.

A signal may be attached to a classifier, which means that instances of the classifier will be able to receive that signal. This is facilitated by declaring a reception by the classifier. An exception is a special kind of signal, typically used to signal fault situations. The sender of the exception aborts execution and execution resumes with the receiver of the exception, which may be the sender itself. Unlike other signals, the receiver of an exception is determined implicitly by the interaction sequence during execution; it is not explicitly specified as the target of the send action.

The reception of a stimulus originating from a call action by an instance causes the invocation of an operation on the receiver. The receiver executes the method that is found in the full descriptor of the class that corresponds to the operation. The reception of a stimulus originating from a signal by an instance may cause a transition and subsequent effects as specified by the state machine for the classifier of the recipient. This form of behavior is described in the State Machines package. Note that the invoked behavior is described by methods and state machine transitions. Operations and receptions merely declare that a classifier accepts a given operation invocation or signal but they do not specify the implementation.

Action

An action is a specification of a computable statement. Each kind of action is defined as a subclass of action. The following kinds of actions are defined:

- send action is an action in which a stimulus is created that causes a signal event for the receiver(s).
- call action is an action in which a stimulus is created that causes an operation to be invoked on the receiver.
- create action is an action in which an instance is created based on the definitions of the specified set of classifiers.
- terminate action is an action in which an instance causes itself to cease to exist.
- destroy action is an action in which an instance causes another instance to cease to exist.
- return action is an action that returns a value to a caller.

2 UML Semantics

- assignment action is an action that assigns an instance to an attribute link or a link.
- uninterpreted action is an action that has no interpretation in UML.

Each action specifies the target of the action and the arguments of the action. The target of an action is an object set expression which resolves into zero or more instances when the action is executed, e.g. the receiver of a stimulus or the instance to be destroyed. The action also specifies if it should iterate over the set of target instances (recurrence). Note, however, that UML does not define if the action is applied to the target instances sequentially or in parallel. The recurrence can also (in the degenerated case) be used for specification of a condition, which must be fulfilled if the action is to be applied to the target; otherwise, the request is neglected.

The arguments of the action resolve into a sequence of instances when the action is executed. These instances are the actual arguments of e.g. the stimulus being dispatched by the action, i.e. the instances passed with a signal or the instances used in an operation invocation. The argument sequence may be dependent on the recurrence, i.e. the arguments may vary dependent on the actual target.

An action is always executed within the context of an instance, so the target set expression and the argument expressions are evaluated within an instance.

2.10 Collaborations

2.10.1 Overview

The Collaborations package is a subpackage of the Behavioral Elements package. It specifies the concepts needed to express how different elements of a model interact with each other from a structural point of view. The package uses constructs defined in the Foundation package of UML as well as in the Common Behavior package.

A Collaboration defines a specific way to use the Model Elements in a Model. It describes how different kinds of Classifiers and their Associations are to be used in accomplishing a particular task. The Collaboration defines a restriction of, or a projection of, a collection of Classifiers, i.e. what properties Instances of the participating Classifiers must have when performing a particular collaboration. The same Classifier or Association can appear in several Collaborations, and several times in one Collaboration, each time in a different role. In each appearance it is specified which of the properties of the Classifier or the Association are needed in that particular usage. These properties are a subset of all the properties of that Classifier or Association. A set of Instances and Links conforming to the participants specified in the Collaboration cooperate when the specified task is performed. Hence, the Classifier structure implies the possible collaboration structures of conforming Instances. A Collaboration is a GeneralizableElement. This implies that one Collaboration may specify a task which is a specialization of another Collaboration's task. A Collaboration may be presented in a diagram, either showing the restricted views of the participating Classifiers and Associations, or by showing Instances and Links conforming to the restricted views.

Collaborations can be used for expressing several different things, like how use cases are realized, actor structures of ROOM, OOFram role models, and collaborations as defined in Catalysis. They are also used for setting up the context of Interactions and for defining the mapping between the specification part and the realization part of a Subsystem.

An Interaction defined in the context of a Collaboration specifies the details of the communications that should take place in accomplishing a particular task. A communication is specified with a Message, which defines the roles of the sender and the receiver Instances, as well as the Action that will cause the communication. The order of the communications is also specified by the Interaction.

The following sections describe the abstract syntax, well-formedness rules and semantics of the Collaborations package.

2.10.2 Abstract Syntax

The abstract syntax for the Collaborations package is expressed in graphic notation in Figure 2-17.

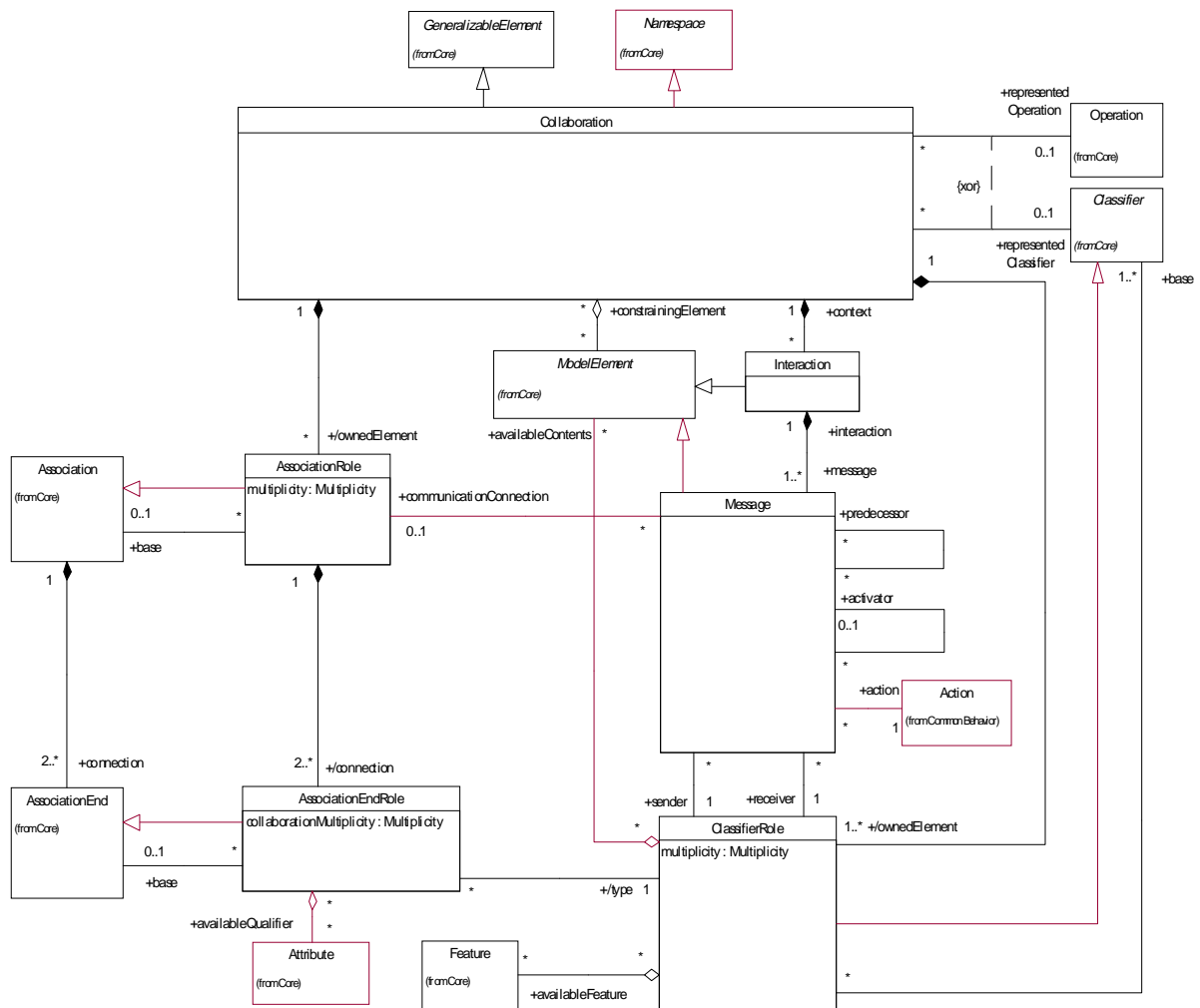

Figure 2-17 Collaborations

AssociationEndRole

An association-end role specifies an endpoint of an association as used in a collaboration.

In the metamodel an AssociationEndRole is part of an AssociationRole and specifies the connection of an AssociationRole to a ClassifierRole. It is related to the AssociationEnd, declaring the corresponding part in an Association.

Attributes

collaborationMultiplicity The number of LinkEnds playing this role in a Collaboration.

Associations

<i>availableQualifier</i>	The subset of Qualifiers that are used in the Collaboration.
<i>base</i>	The AssociationEnd which the AssociationEndRole is a projection of.

AssociationRole

An association role is a specific usage of an association needed in a collaboration.

In the metamodel an AssociationRole specifies a restricted view of an Association used in a Collaboration. An AssociationRole is a composition of a set of AssociationEndRoles corresponding to the AssociationEnds of its base Association.

Attributes

<i>multiplicity</i>	The number of Links playing this role in a Collaboration.
---------------------	---

Associations

<i>base</i>	The Association which the AssociationRole is a view of.
-------------	---

ClassifierRole

A classifier role is a specific role played by a participant in a collaboration. It specifies a restricted view of a classifier, defined by what is required in the collaboration.

In the metamodel a ClassifierRole specifies one participant of a Collaboration, i.e. a role Instances conform to. A ClassifierRole defines a set of Features, which is a subset of those available in the base Classifiers, as well as a subset of ModelElements contained in the base Classifiers, that are used in the role. The ClassifierRole may be connected to a set of AssociationRoles via AssociationEndRoles. As ClassifierRole is a kind of Classifier, a Generalization relationship may be defined between two ClassifierRoles. The child role is a specialization of the parent, i.e. the Features and the contents of the child includes the Features and contents of the parent.

Attributes

<i>multiplicity</i>	The number of Instances playing this role in a Collaboration.
---------------------	---

2 UML Semantics

Associations

<i>availableContents</i>	The subset of ModelElements contained in the base Classifier which is used in the Collaboration.
<i>availableFeature</i>	The subset of Features of the base Classifier which is used in the Collaboration.
<i>base</i>	The Classifiers which the ClassifierRole is a view of.

Collaboration

A collaboration describes how an operation or a classifier, like a use case, is realized by a set of classifiers and associations used in a specific way. The collaboration defines a set of roles to be played by instances and links, as well as a set of interactions that define the communication between the instances when they play the roles.

In the metamodel a Collaboration contains a set of ClassifierRoles and AssociationRoles, which represent the Classifiers and Associations that take part in the realization of the associated Classifier or Operation. The Collaboration may also contain a set of Interactions that are used for describing the behavior performed by Instances conforming to the participating ClassifierRoles.

A Collaboration specifies a view (restriction, slice, projection) of a model of Classifiers. The projection describes the required relationships between Instances that conform to the participating ClassifierRoles, as well as the required subsets of the Features and contained ModelElements of these Classifiers. Several Collaborations may describe different projections of the same set of Classifiers. Hence, a Classifier can be a base for several ClassifierRoles.

A Collaboration may also reference a set of ModelElements, usually Classifiers and Generalizations, needed for expressing structural requirements, such as Generalizations required between the Classifiers themselves to fulfill the intent of the Collaboration.

A Collaboration is a GeneralizableElement which implies that one Collaboration may specify a task which is a specialization of the task of another Collaboration.

Associations

<i>constrainingElement</i>	The ModelElements that add extra constraints, like Generalization and Constraint, on the ModelElements participating in the Collaboration.
<i>interaction</i>	The set of Interactions that are defined within the Collaboration.
<i>ownedElement</i>	(Inherited from Namespace) The set of roles defined by the Collaboration. These are ClassifierRoles and AssociationRoles.
<i>representedClassifier</i>	The Classifier the Collaboration is a realization of. (Used if the Collaboration represents a Classifier.)
<i>representedOperation</i>	The Operation the Collaboration is a realization of. Used if the Collaboration represents an Operation.)

Interaction

An interaction specifies the communication between instances performing a specific task. Each interaction is defined in the context of a collaboration.

In the metamodel an Interaction contains a set of Messages specifying the communication between a set of Instances conforming to the ClassifierRoles of the owning Collaboration.

Associations

<i>context</i>	The Collaboration which defines the context of the Interaction.
<i>message</i>	The Messages that specify the communication in the Interaction.

Message

A message defines a particular communication between instances that is specified in an interaction.

In the metamodel a Message defines one specific kind of communication in an Interaction. A communication can be e.g. raising a Signal, invoking an Operation, creating or destroying an Instance. The Message specifies not only the kind of communication, but also the roles of the sender and the receiver, the dispatching Action, and the role played by the communication Link. Furthermore, the Message defines the relative sequencing of Messages within the Interaction.

Associations

<i>action</i>	The Action which causes a Stimulus to be sent according to the Message.
<i>activator</i>	The Message which invokes the behavior causing the dispatching of the current Message.
<i>communicationConnection</i>	The AssociationRole played by the Links used in the communications specified by the Message.
<i>interaction</i>	The Interaction of which the Message is a part.
<i>receiver</i>	The role of the Instance that receives the communication and reacts to it.
<i>predecessor</i>	The set of Messages whose completion enables the execution of the current Message. All of them must be completed before execution begins.
<i>sender</i>	The role of the Instance that invokes the communication and possibly receives a response.

2.10.3 Well-Formedness Rules

The following well-formedness rules apply to the Collaborations package.

AssociationEndRole

- [1] The type of the ClassifierRole must conform to the type of the base AssociationEnd.
- ```
self.type.base = self.base.type
```
- or**
- ```
self.type.base.allParents->includes (self.base.type)
```
- [2] The type must be a kind of ClassifierRole.
- ```
self.type.oclIsKindOf (ClassifierRole)
```
- [3] The qualifiers used in the AssociationEndRole must be a subset of those in the base AssociationEnd.
- ```
self.base.qualifier->includesAll (self.availableQualifier)
```
- [4] In a collaboration an association may only be used for traversal if it is allowed by the base association.
- ```
self.isNavigable implies self.base.isNavigable
```

### *AssociationRole*

- [1] The AssociationEndRoles must conform to the AssociationEnds of the base Association.
- ```
Sequence{ 1..(self.connection->size) }->forall (index |  
self.connection->at(index).base =  
self.base.connection->at(index))
```
- [2] The endpoints must be a kind of AssociationEndRoles.
- ```
self.connection->forall(r | r.oclIsKindOf (AssociationEndRole))
```

### *ClassifierRole*

- [1] The AssociationRoles connected to the ClassifierRole must match a subset of the Associations connected to the base Classifiers.
- ```
self.allAssociations->forall( ar |  
self.base.allAssociations->exists ( a | ar.base = a ) )
```
- [2] The Features and contents of the ClassifierRole must be subsets of those of the base Classifiers.
- ```
self.base.allFeatures->includesAll (self.allAvailableFeatures)
and
self.base.allContents->includesAll (self.allAvailableContents)
```
- [3] A ClassifierRole does not have any Features of its own.
- ```
self.allFeatures->isEmpty
```

Additional operations

- [1] The operation *allAvailableFeatures* results in the set of all Features contained in the ClassifierRole together with those contained in the parents.

```
allAvailableFeatures : Set(Feature);
allAvailableFeatures = self.availableFeature->union
    (self.parent.allAvailableFeatures)
```

[2] The operation *allAvailableContents* results in the set of all ModelElements contained in the ClassifierRole together with those contained in the parents.

```
allAvailableContents : Set(ModelElement);
allAvailableContents = self.availableContents->union
    (self.parent.allAvailableContents)
```

Collaboration

[1] All Classifiers and Associations of the ClassifierRoles and AssociationRoles in the Collaboration must be included in the namespace owning the Collaboration.

```
self.allContents->forall ( e |
    (e.ocIsKindOf (ClassifierRole) implies
        self.namespace.allContents->includes (
            e.ocAsType(ClassifierRole).base) )
and
    (e.ocIsKindOf (AssociationRole) implies
        self.namespace.allContents->includes (
            e.ocAsType(AssociationRole).base) ))
```

[2] All the constraining ModelElements must be included in the namespace owning the Collaboration.

```
self.constrainingElement->forall ( ce |
    self.namespace.allContents->includes (ce) )
```

[3] If a ClassifierRole or an AssociationRole does not have a name then it should be the only one with a particular base.

```
self.allContents->forall ( p |
    (p.ocIsKindOf (ClassifierRole) implies
        p.name = '' implies
            self.allContents->forall ( q |
                q.ocIsKindOf(ClassifierRole) implies
                    (p.ocAsType(ClassifierRole).base =
                        q.ocAsType(ClassifierRole).base implies
                            p = q) ) )
and
    (p.ocIsKindOf (AssociationRole) implies
        p.name = '' implies
            self.allContents->forall ( q |
                q.ocIsKindOf(AssociationRole) implies
                    (p.ocAsType(AssociationRole).base =
```

2 UML Semantics

```
q.oclAsType(AssociationRole).base implies
    p = q) ) )
)
```

[4] A Collaboration may only contain ClassifierRoles and AssociationRoles, and the Generalizations and the Constraints between them.

```
self.allContents->forall ( p |
    p.oclIsKindOf (ClassifierRole) or
    p.oclIsKindOf (AssociationRole) or
    p.oclIsKindOf (Generalization) or
    p.oclIsKindOf (Constraint) )
```

[5] A role with the same name as one of the roles in a parent of the Collaboration must be a child (a specialization) of that role.

```
self.contents->forall ( c |
    self.parent.allContents->forall ( p |
        c.name = p.name implies c.allParents->include (p) ))
```

Additional operations

[1] The operation *allContents* results in the set of all ModelElements contained in the Collaboration together with those contained in the parents except those that have been specialized.

```
allContents : Set(ModelElement);
allContents = self.contents->union (
    self.parent.allContents->reject ( e |
        self.contents.name->include (e.name) ))
```

Interaction

[1] All Signals being sent must be included in the namespace owning the Collaboration in which the Interaction is defined.

```
self.message->forall ( m |
    m.action.oclIsKindOf(SendAction) implies
        self.context.namespace.allContents->includes (
            m.action->oclAsType (SendAction).signal) )
```

Message

[1] The sender and the receiver must participate in the Collaboration which defines the context of the Interaction.

```
self.interaction.context.ownedElement->includes (self.sender)
and
self.interaction.context.ownedElement->includes (self.receiver)
```

[2] The predecessors and the activator must be contained in the same Interaction.

```
self.predecessor->forall ( p | p.interaction = self.interaction )
and
self.activator->forall ( a | a.interaction = self.interaction )
```

[3] The predecessors must have the same activator as the Message.

```
self.allPredecessors->forall ( p | p.activator = self.activator )
```

[4] A Message cannot be the predecessor of itself.

```
not self.allPredecessors->includes (self)
```

[5] The communicationLink of the Message must be an AssociationRole in the context of the Message's Interaction

```
self.interaction.context.ownedElement->includes (
    self.communicationConnection)
```

[6] The sender and the receiver roles must be connected by the AssociationRole which acts as the communication connection.

```
self.communicationConnection->size > 0 implies
self.communicationConnection.connection->exists (ar |
    ar.type = self.sender)
and
self.communicationConnection.connection->exists (ar |
    ar.type = self.receiver)
```

Additional operations

[1] The operation allPredecessors results in the set of all Messages that precede the current one.

```
allPredecessors : Set(Message);
allPredecessors = self.predecessor->union
    (self.predecessor.allPredecessors)
```

2.10.4 Semantics

This section provides a description of the semantics of the elements in the Collaborations package. It is divided into two parts: Collaboration and Interaction.

Collaboration

In the following text the term instance of a collaboration denotes the set of instances that together participate in and perform one specific collaboration.

The purpose of a collaboration is to specify how an operation or a classifier, like a use case, is realized by a set of classifiers and associations. Together, the classifiers and their associations participating in the collaboration meet the requirements of the realized operation or classifier. The collaboration defines a context in which the behavior of the realized element can be

2 UML Semantics

specified in terms of interactions between the participants of the collaboration. Thus, while a model describes a whole system, a collaboration is a slice, or a projection, of that model. A collaboration defines a usage of a subset of the model's contents.

A collaboration may be presented at two different levels: specification level or instance level. A diagram presenting the collaboration at the specification level will show classifier roles and association roles, while a diagram at the instance level will show instances and links conforming to the roles in the collaboration.

In a collaboration it is specified what properties instances must have to be able to take part in the collaboration, i.e. each participant specifies the required set of features a conforming instance must have. Furthermore, the collaboration also states what associations must exist between the participants, as well as what classifiers a participant, like a subsystem, must contain. Neither all features nor all contents of the participating classifiers, and not all associations between these classifiers are always required in a particular collaboration. Because of this, a collaboration is not actually defined in terms of classifiers, but classifier roles. Thus, while a classifier is a complete description of instances, a classifier role is a description of the features required in a particular collaboration, i.e. a classifier role is a projection of, or a view of, a classifier. The classifier so represented is referred to as the base classifier of that particular classifier role. In fact, since an instance may originate from several classifiers (multiple classification), a classifier role may have several base classifiers. Several classifier roles may have the same base classifier, even in the same collaboration, but their features and contained elements may be different subsets of the features and contained elements of the classifier, respectively. These classifier roles then specify different roles played by (usually different) instances of the same classifier. When the collaboration represents a classifier, its base classifiers can be classifiers of any kind, like classes or subsystems, while in a collaboration specifying the realization of an operation, the base classifiers are the operation's parameter types together with the attribute types and contained classifiers of the classifier owning the operation.

In a collaboration the association roles define what associations are needed between the classifiers in this context. Each association role represents the usage of an association in the collaboration, and it is defined between the classifier roles that represent the associated classifiers. The represented association is called the base association of the association role. As the association roles specify a particular usage of an association in a specific collaboration, all constraints expressed by the association ends are not necessarily required to be fulfilled in the specified usage. The multiplicity of the association end may be reduced in the collaboration, i.e. the upper and the lower bounds of the association end roles may be lower than those of the corresponding base association end, as it might be that only a subset of the associated instances participate in the collaboration instance. Similarly, an association may be traversed in some, but perhaps not all, of the allowed directions in the specific collaboration, i.e. the `isNavigable` property of an association end role may be false even if that property of the base association end is true. (However, the opposite is not true, i.e. an association may not be used for traversal in a direction which is not allowed according to the `isNavigable` properties of the association ends.) The changeability and ordering of an association end may be strengthened in an association-end role, i.e. in a particular usage the end is used in a more restricted way than is defined by the association. Furthermore, if an association has a collection of qualifiers (see the Core), some of them may be used in a specific collaboration. An association end role may therefore include a subset of the qualifiers defined by the corresponding association end of the base association.

An instance participating in a collaboration instance plays a specific role, i.e. conforms to a classifier role, in the collaboration. The number of instances that should play one specific role in one instance of a collaboration is specified by the classifier role's multiplicity. Different instances may play the same role but in different instances of the collaboration. Since all these instances play the same role, they must all conform to the classifier role specifying the role. Thus, they are often instances of the base classifier of the classifier role, or one of its descendants. However, since the only requirement on conforming instances is that they must offer operations according to the classifier role, as well as support attribute links corresponding to the attributes specified by the classifier role, and links corresponding to the association roles connected to the classifier role, they may be instances of any classifier meeting this requirement. The instances may, of course, have more attribute links than required by the classifier role, which for example would be the case if they originate from a classifier being a child of the base classifier. Moreover, a conforming instance may also support more attribute links than required if it originates from multiple classifiers. Finally, one instance may play different roles in different instances of one collaboration. In fact, the instance may play multiple roles in the same instance of a collaboration.

Collaborations may have generalization relationships to other collaborations, which means that one collaboration specifies a specialization of another collaboration's task. This implies that the child collaboration not only contains all the roles of the parent collaboration but may also contain new roles; the former roles may possibly be specialized with new features (as classifier roles are also generalizable elements). In this way it is possible to specialize a collaboration both by adding new roles and by replacing existing roles with specializations of them. The specialized role, i.e. a role with a generalization relationship to the replaced role, may both have new features and replace (override) features of its parent. Note that the base classifiers of the specialized roles are not necessarily specializations of the base classifiers of the parent's roles; it is enough that they contain all the required features.

How the instances conforming to the roles of a collaboration should interact to jointly perform the behavior of the realized classifier is specified with a set of interactions (see below). The collaboration thus specifies the context in which these interactions are performed. If the collaboration represents an operation, the context includes things like parameters, attributes and classifiers contained in the classifier owning the operation. The interactions then specify how the arguments, the attribute values, the instances etc. will cooperate to perform the behavior specified by the operation. If the collaboration is a specialization of another collaboration, all communications specified by the parent collaboration are also included in the child, as the child collaboration includes all the roles of the parent. However, new messages may be inserted into these sequences of communication, since the child may include specializations of the parent's roles as well as new roles. The child may of course also include completely new interactions that do not exist in the parent.

Two or more collaborations may be composed in order to refine a superordinate collaboration. For example, when refining a superordinate use case into a set of subordinate use cases, the collaborations specifying each of the subordinate use cases may be composed into one collaboration, which will be a (simple) refinement of the superordinate collaboration. The composition is done by observing that at least one instance must participate in both sets of collaborating instances. This instance has to conform to one classifier role in each collaboration. In the composite collaboration these two classifier roles are merged into a new one, which will contain all features included in either of the two original classifier roles. The

new classifier role will, of course, be able to fulfill the requirements of both of the previous collaborations, so the instance participating in both of the two sets of collaborating instances will conform to the new classifier role.

A collaboration may be a specification of a template. There will not be any instances of such a template collaboration, but it can be used for generating ordinary collaborations, which may be instantiated. Template collaborations may have parameters that act like placeholders in the template. Usually, these parameters would be used as base classifiers and associations, but other kinds of model elements can also be defined as parameters in the collaboration, like operation or signal. In a collaboration generated from the template these parameters are refined by other model elements that make the collaboration instantiable.

Moreover, a collaboration may also contain a set of constraining model elements, like constraints and generalizations perhaps together with some extra classifiers. These constraining model elements do not participate in the collaboration themselves, but are used for expressing the extra constraints on the participating elements in the collaboration that cannot be covered by the participating roles themselves. For example, in a template it might be required that the base classifiers of two roles must have a common ancestor, or one role must be a subclass of another one. These kinds of requirements cannot be expressed with association roles, as the association roles express the required links between participating instances. An extra set of model elements may therefore be included in the collaboration.

Interaction

The purpose of an interaction is to specify the communication between a set of interacting instances performing a specific task. An interaction is defined within a collaboration, i.e. the collaboration defines the context in which the interaction takes place. The instances performing the communication specified by the interaction conform to the classifier roles of the collaboration.

An interaction specifies the sending of a set of stimuli. These are partially ordered based on which execution thread they belong to. Within each thread the stimuli are sent in a sequential order while stimuli of different threads may be sent in parallel or in an arbitrary order.

A message is a specification of a communication. It specifies the roles of the sender and the receiver instances, as well as which association role specifies the communication link. The message is connected to an action, which specifies the statement that, when executed, causes the communication specified by the message to take place. If the action is a call action or a send action, the signal to be sent or the operation to be invoked in the communication is stated by the action. The action also contains the argument expressions that, when executed, will determine the actual arguments being transmitted in the communication. Moreover, any conditions or iterations of the communication are also specified by the action. Apart from send action and call action, the action connected to a message can also be of other kinds, like create action and destroy action. In these cases, the communication will not raise a signal or invoke an operation, but cause a new instance to be created or an already existing instance to be destroyed. In the case of a create action, the receiver specified by the message is the role to be played by the instance which is created when the action is performed.

The stimuli being sent when an action is executed conforms to a message, implying that the sender and receiver instances of the stimuli are in conformance with the sender and the receiver roles specified by the message. Furthermore, the action dispatching the stimulus is the same as the action attached to the message. If the action connected to the message is a create action or destroy action, the receiver role of the message specify the role to be played by the instance, or was played by the instance, respectively.

The interaction specifies the activator and predecessors of each message. The activator is the message that invoked the procedure which in turn invokes the current message. Every message except the initial message of an interaction thus has an activator. The predecessors are the set of messages that must be completed before the current message may be executed. The first message in a procedure of course has no predecessors. If a message has more than one predecessor, it represents the joining of two threads of control. If a message has more than one successor (the inverse of predecessor), it indicates a fork of control into multiple threads. Thus, the predecessors relationship imposes a partial ordering on the messages within a procedure, whereas the activator relationship imposes a tree on the activation of operations. Messages may be executed concurrently subject to the sequential constraints imposed by the predecessors and activator relationship.

2.10.5 Notes

Pattern is a synonym for a template collaboration that describes the structure of a design pattern. Design patterns involve many nonstructural aspects, such as heuristics for their use and lists of advantages and disadvantages. Such aspects are not modeled by UML and may be represented as text or tables.

2 UML Semantics

2.11 Use Cases

2.11.1 Overview

The Use Cases package is a subpackage of the Behavioral Elements package. It specifies the concepts used for definition of the functionality of an entity like a system. The package uses constructs defined in the Foundation package of UML as well as in the Common Behavior package.

The elements in the Use Cases package are primarily used to define the behavior of an entity, like a system or a subsystem, without specifying its internal structure. The key elements in this package are UseCase and Actor. Instances of use cases and instances of actors interact when the services of the entity are used. How a use case is realized in terms of cooperating objects, defined by classes inside the entity, can be specified with a Collaboration. A use case of an entity may be refined to a set of use cases of the elements contained in the entity. How these subordinate use cases interact can also be expressed in a Collaboration. The specification of the functionality of the system itself is usually expressed in a separate use-case model, i.e. a Model stereotyped «useCaseModel» (see “Stereotypes and Notation” on page 4-5). The use cases and actors in the use-case model are equivalent to those of the top-level package.

The following sections describe the abstract syntax, well-formedness rules and semantics of the Use Cases package.

2.11.2 Abstract Syntax

The abstract syntax for the Use Cases package is expressed in graphic notation in Figure 2-18 on page 2-118.

2 UML Semantics

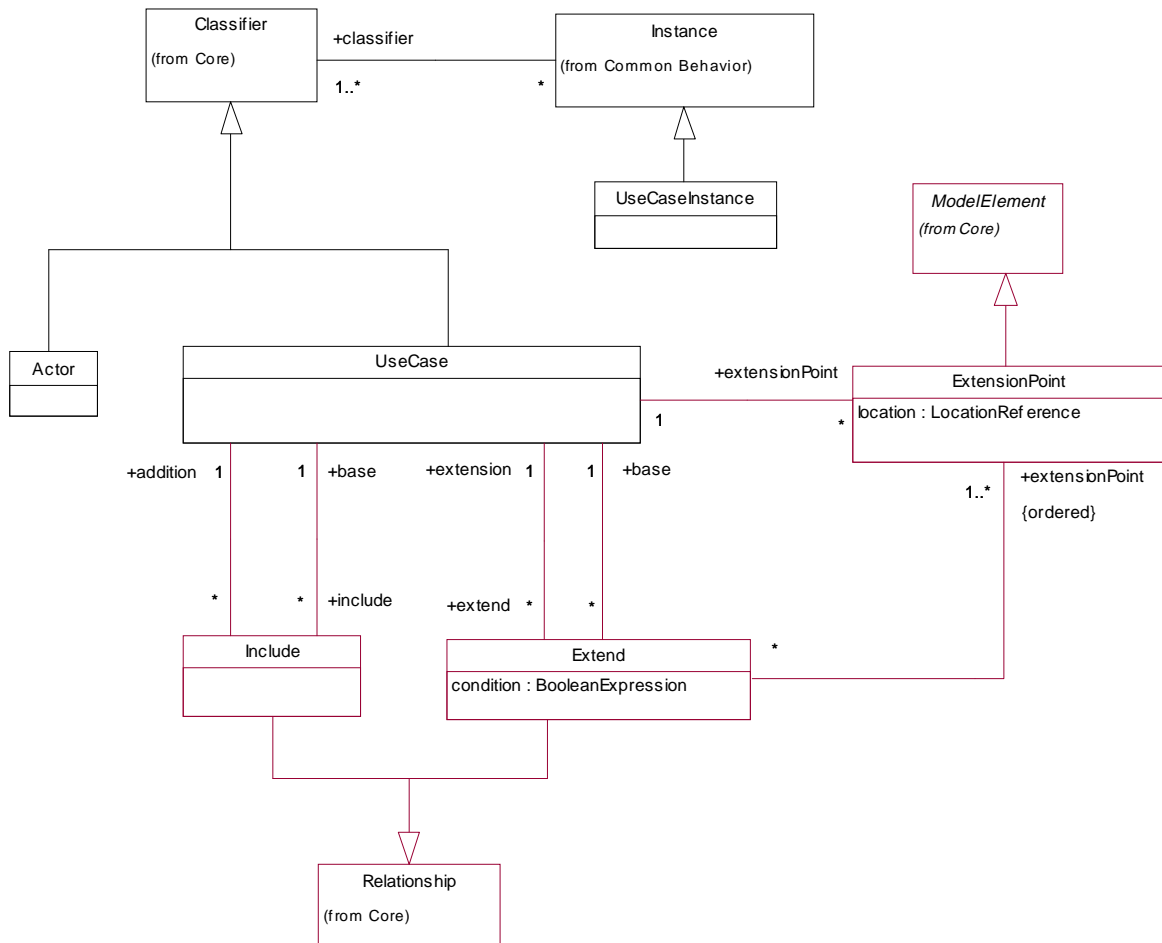

Figure 2-18 Use Cases

The following metaclasses are contained in the Use Cases package.

Actor

An *actor* defines a coherent set of roles that users of an entity can play when interacting with the entity. An actor may be considered to play a separate role with regard to each use case with which it communicates.

In the metamodel Actor is a subclass of Classifier. An Actor has a Name and may communicate with a set of UseCases, and, at realization level, with Classifiers taking part in the realization of these UseCases. An Actor may also have a set of Interfaces, each describing how other elements may communicate with the Actor.

An Actor may have generalization relationships to other Actors. This means that the child Actor will be able to play the same roles as the parent Actor, i.e. communicate with the same set of UseCases, as the parent Actor.

Extend

An *extend* relationship defines that instances of a use case may be augmented with some additional behavior defined in an extending use case.

In the metamodel an Extend relationship is a directed relationship implying that a UseCaseInstance of the base UseCase may be augmented with the structure and behavior defined in the extending UseCase. The relationship consists of a condition, which must be fulfilled if the extension is to take place, and a sequence of references to extension points in the base UseCase where the additional behavior fragments are to be inserted.

Attributes

<i>condition</i>	an expression specifying the condition which must be fulfilled if the extension is to take place.
------------------	---

Associations

<i>base</i>	the UseCase to be extended.
<i>extension</i>	the UseCase specifying the extending behavior.
<i>extensionPoint</i>	a sequence of extension-points in the base UseCase specifying where the additions are to be inserted.

ExtensionPoint

An extension point references one or a collection of locations in a use case where the use case may be extended.

In the metamodel an ExtensionPoint has a name and one or a collection of descriptions of locations in the behavior of the owning use case, where a piece of behavior may be inserted into the owning use case.

Attributes

<i>location</i>	a reference to one location or a collection of locations where an extension to the behavior of the use case may be inserted.
-----------------	--

Include

An include relationship defines that a use case contains the behavior defined in another use case.

2 UML Semantics

In the metamodel an Include relationship is a directed relationship between two UseCases implying that the behavior in the addition UseCase is inserted into the behavior of the base UseCase. The base UseCase may only depend on the result of performing the behavior defined in the addition UseCase, but not on the structure, i.e. on the existence of specific attributes and operations, of the addition UseCase.

Associations

<i>addition</i>	the UseCase specifying the additional behavior.
<i>base</i>	the UseCase which is to include the addition.

UseCase

The use case construct is used to define the behavior of a system or other semantic entity without revealing the entity's internal structure. Each use case specifies a sequence of actions, including variants, that the entity can perform, interacting with actors of the entity.

In the metamodel UseCase is a subclass of Classifier, specifying the sequences of actions performed by an instance of the UseCase. The actions include changes of the state and communications with the environment of the UseCase. The sequences can be described using many different techniques, like Operation and Methods, ActivityGraphs, and StateMachines.

There may be Associations between UseCases and the Actors of the UseCases. Such an Association states that an instance of the UseCase and a user playing one of the roles of the Actor communicate. UseCases may be related to other UseCases by Extend, Include, and Generalization relationships. An Include relationship means that a UseCase includes the behavior described in another UseCase, while an Extend relationship implies that a UseCase may extend the behavior described in another UseCase, ruled by a condition. Generalization between UseCases means that the child is a more specific form of the parent. The child inherits all Features and Associations of the parent, and may add new Features and Associations.

The realization of a UseCase may be specified by a set of Collaborations, i.e. the Collaborations define how Instances in the system interact to perform the sequences of the UseCase.

Associations

<i>extend</i>	a collection of Extend relationships to UseCases that the UseCase extends.
<i>extensionPoint</i>	defines a collection of ExtensionPoints where the UseCase may be extended.
<i>include</i>	a collection of Include relationships to UseCases that the UseCase includes.

UseCaseInstance

A use case instance is the performance of a sequence of actions specified in a use case.

In the metamodel `UseCaseInstance` is a subclass of `Instance`. Each method performed by a `UseCaseInstance` is performed as an atomic transaction, i.e. it is not interrupted by any other `UseCaseInstance`.

An explicitly described `UseCaseInstance` is called a scenario.

2.11.3 Well-FormednessRules

The following well-formedness rules apply to the Use Cases package.

Actor

[1] Actors can only have Associations to UseCases, Subsystems, and Classes and these Associations are binary.

```
self.associations->forAll(a |
  a.connection->size = 2 and
  a.allConnections->exists(r | r.type.ocIsKindOf(Actor)) and
  a.allConnections->exists(r |
    r.type.ocIsKindOf(UseCase) or
    r.type.ocIsKindOf(Subsystem) or
    r.type.ocIsKindOf(Class)))
```

[2] Actors cannot contain any Classifiers.

```
self.contents->isEmpty
```

Extend

[1] The referenced `ExtensionPoints` must be included in set of `ExtensionPoint` in the target `UseCase`.

```
self.base.allExtensionPoints -> includesAll (self.location)
```

ExtensionPoint

[1] The name must not be the empty string

```
not self.name = ''
```

Include

No extra well-formedness rules.

UseCase

[1] UseCases can only have binary Associations.

```
self.associations->forAll(a | a.connection->size = 2)
```

2 UML Semantics

[2] UseCases can not have Associations to UseCases specifying the same entity.

```
self.associations->forAll(a |
  a.allConnections->forAll(s, o|
    (s.type.specificationPath->isEmpty and
     o.type.specificationPath->isEmpty )
    or
    (not s.type.specificationPath->includesAll(
      o.type.specificationPath) and
     not o.type.specificationPath->includesAll(
      s.type.specificationPath))
  ))
```

[3] A UseCase cannot contain any Classifiers.

```
self.contents->isEmpty
```

[4] The names of the ExtensionPoints must be unique within the UseCase.

```
self.allExtensionPoints -> forAll (x, y |
  x.name = y.name implies x = y )
```

Additional operations

[1] The operation specificationPath results in a set containing all surrounding Namespaces that are not instances of Package.

```
specificationPath : Set(Namespace)
specificationPath = self.allSurroundingNamespaces->select(n |
  n.ocIsKindOf(Subsystem) or n.ocIsKindOf(Class))
```

[2] The operation allExtensionPoints results in a set containing all ExtensionPoints of the UseCase.

```
allExtensionPoints : Set(ExtensionPoint)
allExtensionPoints = self.allSupertypes.extensionPoint -> union (
  self.extensionPoint)
```

UseCaseInstance

[1] The Classifier of a UseCaseInstance must be a UseCase.

```
self.classifier->forAll ( c | c.ocIsKindOf (UseCase) )
```

2.11.4 Semantics

This section provides a description of the semantics of the elements in the Use Cases package, and its relationship to other elements in the Behavioral Elements package.

Actor

Figure 2-19 Actor Illustration

Actors model parties outside an entity, such as a system, a subsystem, or a class, which interact with the entity. Each actor defines a coherent set of roles users of the entity can play when interacting with the entity. Every time a specific user interacts with the entity, it is playing one such role. An instance of an actor is a specific user interacting with the entity. Any instance that conforms to an actor can act as an instance of the actor. If the entity is a system the actors represent both human users and other systems. Some of the actors of a lower level subsystem or a class may coincide with actors of the system, while others appear inside the system. The roles defined by the latter kind of actors are played by instances of classifiers in other packages or subsystems; in the latter case the classifier may belong to either the specification part or the realization part of the subsystem.

Since an actor is outside the entity, its internal structure is not defined but only its external view as seen from the entity. Actor instances communicate with the entity by sending and receiving message instances to and from use case instances and, at realization level, to and from objects. This is expressed by associations between the actor and the use case or the class. Furthermore, interfaces can be connected to an actor, defining how other elements may interact with the actor.

Two or more actors may have commonalities, i.e. communicate with the same set of use cases in the same way. The commonality is expressed with generalizations to another (possibly abstract) actor, which models the common role(s). An instance of a child can always be used where an instance of the parent is expected.

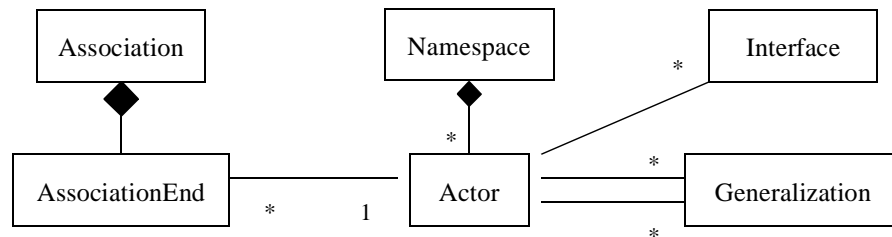
2 UML Semantics

UseCase

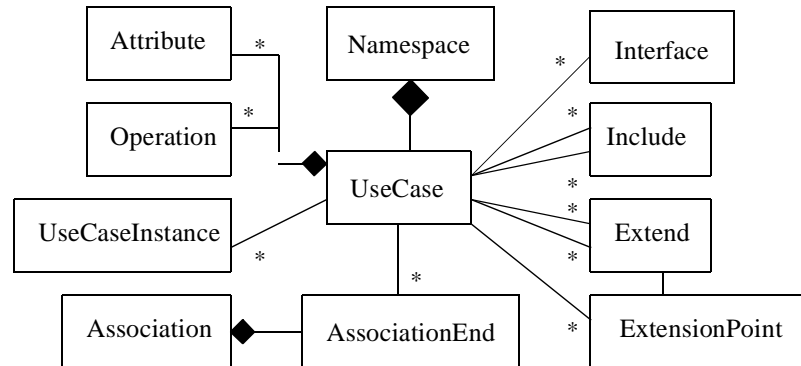

Figure 2-20 UseCase Illustration

In the following text the term entity is used when referring to a system, a subsystem, or a class and the terms model element and element denote a subsystem or a class.

The purpose of a use case is to define a piece of behavior of an entity without revealing the internal structure of the entity. The entity specified in this way may be a system or any model element that contains behavior, like a subsystem or a class, in a model of a system. Each use case specifies a service the entity provides to its users, i.e. a specific way of using the entity. The service, which is initiated by a user, is a complete sequence. This implies that after its performance the entity will in general be in a state in which the sequence can be initiated again. A use case describes the interactions between the users and the entity as well as the responses performed by the entity, as these responses are perceived from the outside of the entity. A use case also includes possible variants of this sequence, e.g. alternative sequences, exceptional behavior, error handling etc. The complete set of use cases specifies all different ways to use the entity, i.e. all behavior of the entity is expressed by its use cases. These use cases can be grouped into packages for convenience.

From a pragmatic point of view, use cases can be used both for specification of the (external) requirements on an entity and for specification of the functionality offered by an (already realized) entity. Moreover, the use cases also indirectly state the requirements the specified entity poses on its users, i.e. how they should interact so the entity will be able to perform its services.

Since users of use cases always are external to the specified entity, they are represented by actors of the entity. Thus, if the specified entity is a system or a subsystem at the topmost level, the users of its use cases are modeled by the actors of the system. Those actors of a lower level subsystem or a class that are internal to the system are often not explicitly defined. Instead, the use cases relate directly to model elements conforming to these implicit actors, i.e. whose instances play the roles of these actors in interaction with the use cases. These model elements are contained in other packages or subsystems, where in the subsystem case they may be contained in the specification part or the realization part. The distinction between actor and conforming element like this is often neglected; thus, they are both referred to by the term actor.

There may be associations between use cases and actors, meaning that the instances of the use case and the actor communicate with each other. One actor may communicate with several use cases of an entity, i.e. the actor may request several services of the entity, and one use case communicates with one or several actors when providing its service. Note that two use cases specifying the same entity cannot communicate with each other since each of them individually describes a complete usage of the entity. Moreover, use cases always use signals when communicating with actors outside the system, while they may use other communication semantics when communicating with elements inside the system.

The interaction between actors and use cases can be defined with interfaces. An interface of a use case defines a subset of the entire interaction defined in the use case. Different interfaces offered by the same use case need not be disjoint.

A use case can be described in plain text, using operations and methods together with attributes, in activity graphs, by a state machine, or by other behavior description techniques, such as preconditions and postconditions. The interaction between a use case and its actors can also be presented in collaboration diagrams for specification of the interactions between the entity containing the use case and the entity's environment.

A use-case instance is a performance of a use case, initiated by a message instance from an instance of an actor. As a response the use-case instance performs a sequence of actions as specified by the use case, like communicating with actor instances, not necessarily only the initiating one. The actor instances may send new message instances to the use-case instance and the interaction continues until the instance has responded to all input and does not expect any more input, when it ends. Each method performed by a use-case instance is performed as an atomic transaction, i.e. it is not interrupted by any other use-case instance.

In the case where subsystems are used to model the system's containment hierarchy, the system can be specified with use cases at all levels, as use cases can be used to specify subsystems and classes. A use case specifying one model element is then refined into a set of smaller use cases, each specifying a service of a model element contained in the first one. The use case of the whole may be referred to as superordinate to its refining use cases, which, correspondingly, may be called subordinate in relation to the first one. The functionality specified by each superordinate use case is completely traceable to its subordinate use cases. Note, though, that the structure of the container element is not revealed by the use cases, since they only specify the functionality offered by the element. The subordinate use cases of a specific superordinate use case cooperate to perform the superordinate one. Their cooperation is specified by collaborations and may be presented in collaboration diagrams. A specific subordinate use case may appear in several collaborations, i.e. play a role in the performances of several superordinate use cases. In each such collaboration, other roles specify the cooperation with this specific subordinate use case. These roles are the roles played by the actors of that subordinate use case. Some of these actors may be the actors of the superordinate use case, as each actor of a superordinate use case appears as an actor of at least one of the subordinate use cases. Furthermore, the interfaces of a superordinate use case are traceable to the interfaces of those subordinate use cases that communicate with actors that are also actors of the superordinate use case.

The environment of subordinate use cases is the model element containing the model elements specified by these use cases. Thus, from a bottom-up perspective, an interaction between subordinate use cases results in a superordinate use case, i.e. a use case of the container element.

2 UML Semantics

Use cases of classes are mapped onto operations of the classes, since a service of a class in essence is the invocation of the operations of the class. Some use cases may consist of the application of only one operation, while others may involve a set of operations, usually in a well-defined sequence. One operation may be needed in several of the services of the class, and will therefore appear in several use cases of the class.

The realization of a use case depends on the kind of model element it specifies. For example, since the use cases of a class are specified by means of operations of the class, they are realized by the corresponding methods, while the use cases of a subsystem are realized by the elements contained in the subsystem. Since a subsystem does not have any behavior of its own, all services offered by a subsystem must be a composition of services offered by elements contained in the subsystem, i.e. eventually by classes. These elements will collaborate and jointly perform the behavior of the specified use case. One or a set of collaborations describes how the realization of a use case is made. Hence, collaborations are used for specification of both the refinement and the realization of a use case in terms of subordinate use cases.

The usage of use cases at all levels imply not only a uniform way of specification of functionality at all levels, but also a powerful technique for tracing requirements at the system package level down to operations of the classes. The propagation of the effect of modifying a single operation at the class level all the way up to the behavior of the system package is managed in the same way.

Commonalities between use cases can be expressed in three different ways: with generalization, include, and extend relationships. A generalization relationship between use cases implies that the child use case contains all the attributes, sequences of behavior, and extension points defined in the parent use case, and participate in all relationships of the parent use case. The child use case may also define new behavior sequences, as well as add additional behavior into and specialize existing behavior of the inherited ones. One use case may have several parent use cases and one use case may be a parent to several other use cases.

An include relationship between two use cases means that the behavior defined in the target use case is included at one location in the sequence of behavior performed by an instance of the base use case. When a use-case instance reaches the location where the behavior of another use case is to be included, it performs all the behavior described by the included use case and then continues according to its original use case. This means that although there may be several paths through the included use case due to e.g. conditional statements, all of them must end in such a way that the use-case instance can continue according to the original use case. One use case may be included in several other use cases and one use case may include several other use cases. The included use case may not be dependent on the base use case. In that sense the included use case represents encapsulated behavior which may easily be reused in several use cases. Moreover, the base use case may only be dependent on the results of performing the included behavior and not on structure, like Attributes and Associations, of the included use case.

An extend relationship defines that a use case may be augmented with some additional behavior defined in another use case. One use case may extend several use cases and one use case may be extended by several use cases. The base use case may not be dependent of the addition of the extending use case. The extend relationship contains a condition and references a sequence of extension points in the target use case. The condition must be satisfied if the extension is to take place, and the references to the extension points define the locations in the base use case where the additions are to be made. Once an instance of a use case is to perform some behavior

referenced by an extension point of its use case, and the extension point is the first one in an extends relationship's sequence of references to extension points, the condition of the relationship is evaluated. If the condition is fulfilled, the sequence obeyed by the use-case instance is extended to include the sequence of the extending use case. The different parts of the extending use case are inserted at the locations defined by the sequence of extension points in the relationship -- one part at each referenced extension point. Note that the condition is only evaluated once: at the first referenced extension point, and if it is fulfilled all of the extending use case is inserted in the original sequence. An extension point may define one location or a set of locations in the behavior defined by the use case. However, if an extend relationship references a sequence of extension points, only the first one may define a set of locations. All other ones must define exactly one location each. Which of the locations of the first extension point to use is determined by where the extension is triggered. This is not possible for the other ones. In other word, once the extension has been triggered, all location where to add the different part of the extending use case must be uniquely defined. Hence, all extension points, except for the first one, referenced by an extend relationship must define single locations. The description of the location references by an extension point can be made in several different ways, like textual description of where in the behavior the addition should be made, pre-or post conditions, or using the name of a state in a state machine.

Note that the three kinds of relationships described above can only exist between use cases specifying the same entity. The reason for this is that the use cases of one entity specify the behavior of that entity alone, i.e. all use-case instances are performed entirely within that entity. If a use case would have a generalization, include, or extend relationship to a use case of another entity, the resulting use-case instances would involve both entities, resulting in a contradiction. However, generalization, include, and extend relationships can be defined from use cases specifying one entity to use cases of another one if the first entity has a generalization to the second one, since the contents of both entities are available in the first entity. However, the contents of the second entity must be at least protected, so they become available inside the child entity.

As a first step when developing a system, the dynamic requirements of the system as a whole can be expressed with use cases. The entity being specified is then the whole system, and the result is a separate model called a use-case model, i.e. a model with the stereotype «useCaseModel». Next, the realization of the requirements is expressed with a model containing a system package, probably a package hierarchy, and at the bottom a set of classes. If the system package, i.e. a package with the stereotype «topLevelPackage», is a subsystem, its abstract behavior is naturally the same as that of the system. Thus, if use cases are used for the specification part of the system package, these use cases are equivalent to those in the use-case model of the system, i.e. they express the same behavior but possibly slightly differently structured. In other words, all services specified by the use cases of a system package, and only those, define the services offered by the system. Furthermore, if several models are used for modeling the realization of a system, e.g. an analysis model and a design model, the set of use cases of all system packages and the use cases of the use-case model must be equivalent.

2.11.5 Notes

A pragmatic rule of use when defining use cases is that each use case should yield some kind of observable result of value to (at least) one of its actors. This ensures that the use cases are complete specifications and not just fragments.

2 UML Semantics

2.12 State Machines

2.12.1 Overview

The State Machine package is a subpackage of the Behavioral Elements package. It specifies a set of concepts that can be used for modeling discrete behavior through finite state-transition systems. These concepts are based on concepts defined in the Foundation package as well as concepts defined in the Common Behavior package. This enables integration with the other subpackages in Behavioral Elements.

The state machine formalism described in this section is an object-based variant of Harel statecharts. It incorporates several concepts similar to those defined in ROOMcharts, a variant of statechart defined in the ROOM modeling language. The major differences relative to classical Harel statecharts are described on page 157.

State machines can be used to specify behavior of various elements that are being modeled. For example, they can be used to model the behavior of individual entities (e.g., class instances) or to define the interactions (e.g., collaborations) between entities.

In addition, the state machine formalism provides the semantic foundation for activity graphs. This means that activity graphs are simply a special form of state machines.

The following sections describe the abstract syntax, well-formedness rules, and semantics of the State Machines package. Activity graphs are described in section 2.13.

2.12.2 Abstract Syntax

The abstract syntax for state machines is expressed graphically in figure 2-21, which covers all the basic concepts of state machine graphs such as states and transitions. Figure 2-22 describes the abstract syntax of events that can trigger state machine behavior.

The specifications of the concepts defined in these two diagrams are listed in alphabetical order following the figures.

2 UML Semantics

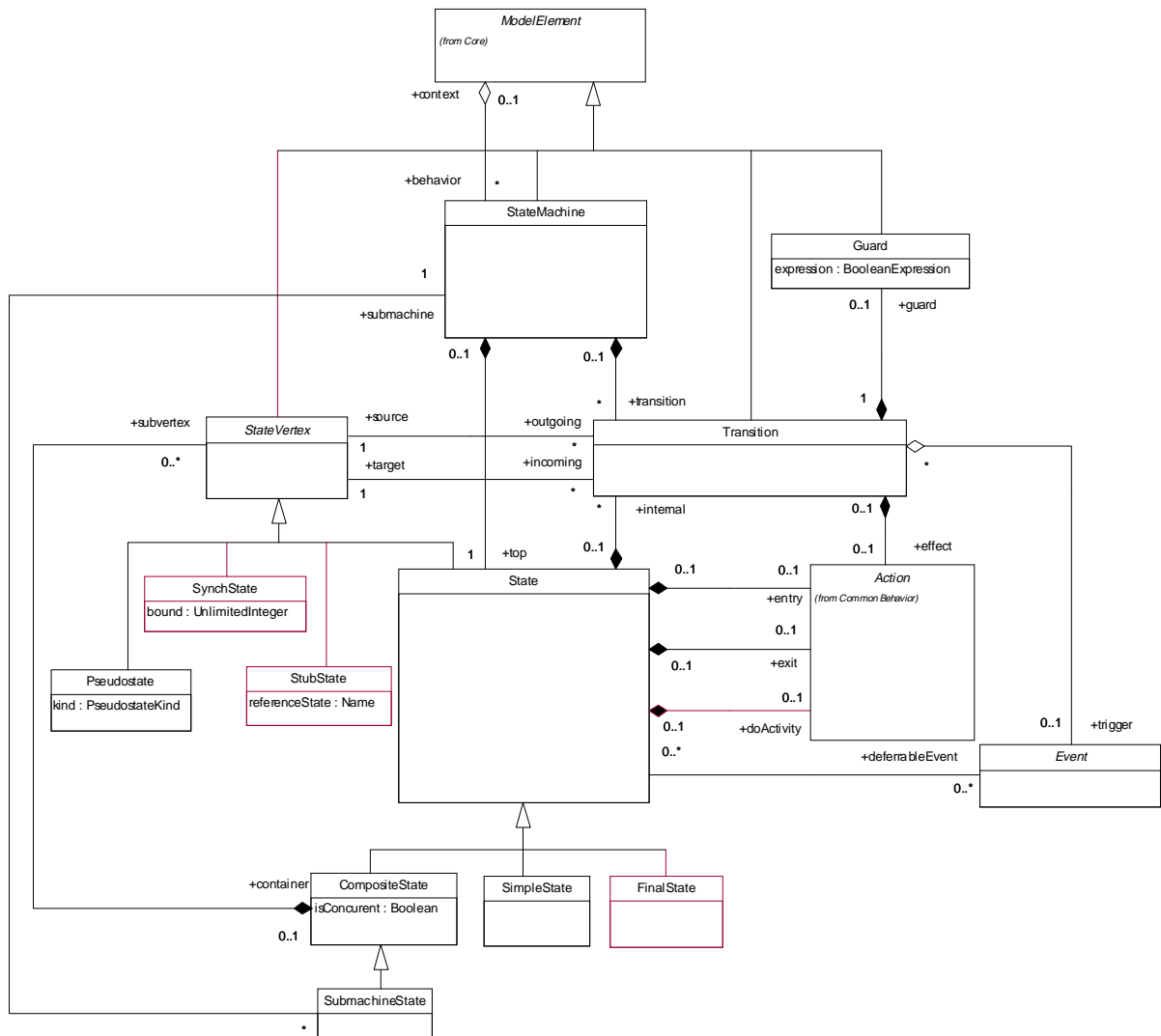

Figure 2-21 State Machines - Main

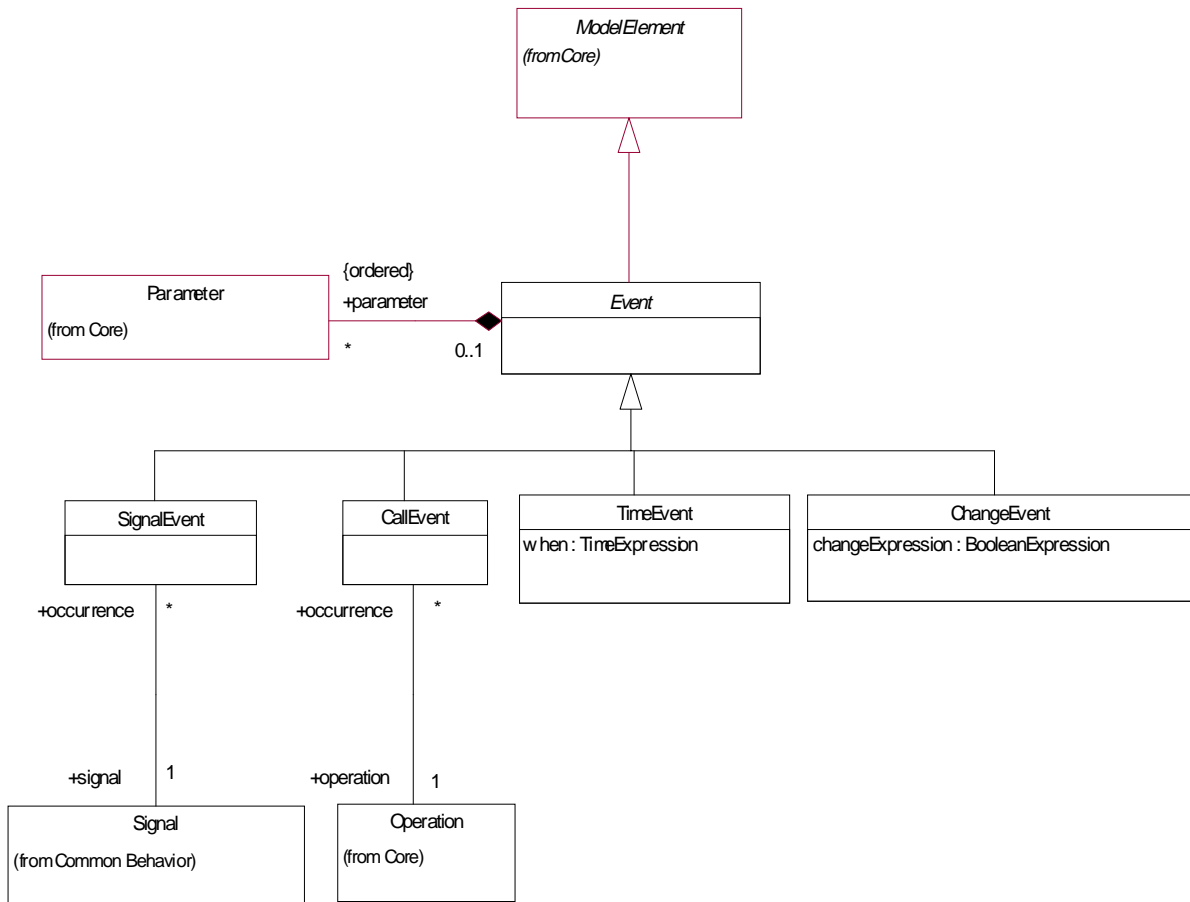

Figure 2-22 State Machines - Events

CallEvent

A call event represents the *reception* of a request to synchronously invoke a specific operation. (Note that a call event instance is distinct from the call action that caused it.) The expected result is the execution of a sequence of actions which characterize the operation behavior at a particular state.

Two special cases of **CallEvent** are the object creation event and the object destruction event.

Associations

operation Designates the operation whose invocation raised the call event

Stereotypes

«create»	Create is a stereotyped call event denoting that the instance receiving that event has just been created. For state machines, it triggers the initial transition at the topmost level of the state machine (and is the only kind of trigger that may be applied to an initial transition).
«destroy»	Destroy is a stereotyped call event denoting that the instance receiving the event is being destroyed.

ChangeEvent

A change event models an event that occurs when an explicit boolean expression becomes true as a result of a change in value of one or more attributes or associations. A change event is raised implicitly and is *not* the result of some explicit change event action.

The change event should not be confused with a guard. A guard is only evaluated at the time an event is dispatched whereas, conceptually, the boolean expression associated with a change event is evaluated continuously until it becomes true. The event that is generated remains until it is consumed even if the boolean expression changes to false after that.

Attributes

<i>changeExpression</i>	The boolean expression that specifies the change event.
-------------------------	---

CompositeState

A composite state is a state that contains other state vertices (states, pseudostates, etc.). The association between the composite and the contained vertices is a composition association. Hence, a state vertex can be a part of at most one composite state.

Any state enclosed within a composite state is called a *substate* of that composite state. It is called a *direct substate* when it is not contained by any other state; otherwise it is referred to as a *transitively nested substate*.

CompositeState is a child of State.

Associations

<i>subvertex</i>	The set of state vertices that are owned by this composite state.
------------------	---

Attributes

<i>isConcurrent</i>	A boolean value that specifies the decomposition semantics. If this attribute is true, then the composite state is decomposed directly into two or more orthogonal conjunctive components called <i>regions</i> (usually associated with concurrent execution). If this attribute is false, then there are no direct orthogonal components in the composite.
<i>isRegion</i>	A derived boolean value that indicates whether a CompositeState is a substate of a concurrent state. If it is true, then this composite state is a direct substate of a concurrent state.

Event

An event is a specification of a type of observable occurrence. The occurrence that generates an event instance is assumed to take place at an instant in time with no duration.

Strictly speaking, the term “event” is used to refer to the type and not to an instance of the type. However, on occasion, where the meaning is clear from the context, the term is also used to refer to an event instance.

Event is a child of ModelElement.

Associations

<i>parameter</i>	The list of parameters defined by the event.
------------------	--

FinalState

A special kind of state signifying that the enclosing composite state is completed. If the enclosing state is the top state, then it means that the entire state machine has completed.

A final state cannot have any outgoing transitions.

FinalState is a child of State.

Guard

A guard is a boolean expression that is attached to a transition as a fine-grained control over its firing. The guard is evaluated when an event instance is dispatched by the state machine. If the guard is true at that time, the transition is enabled, otherwise, it is disabled.

Guards should be pure expressions without side effects. Guard expressions with side effects are ill formed.

Guard is a child of ModelElement.

Attributes

expression The boolean expression that specifies the guard.

PseudoState

A pseudostate is an abstraction that encompasses different types of transient vertices in the state machine graph. They are used, typically, to connect multiple transitions into more complex state transitions paths. For example, by combining a transition entering a fork pseudostate with a set of transitions exiting the fork pseudostate, we get a compound transition that leads to a set of concurrent target states.

The following pseudostate kinds are defined:

- An *initial* pseudostate represents a default vertex that is the source for a single transition to the *default* state of a composite state. There can be at most one initial vertex in a composite state.
- *deepHistory* is used as a shorthand notation that represents the most recent active configuration of the composite state that directly contains this pseudostate; that is, the state configuration that was active when the composite state was last exited. A composite state can have at most one deep history vertex. A transition may originate from the history connector to the *default* deep history state. This transition is taken in case the composite state had never been active before.
- *shallowHistory* is a shorthand notation that represents the most recent active substate of its containing state (but *not* the substates of that substate). A composite state can have at most one shallow history vertex. A transition coming into the shallow history vertex is equivalent to a transition coming into the most recent active substate of a state. A transition may originate from the history connector to the *initial* shallow history state. This transition is taken in case the composite state had never been active before.
- *join* vertices serve to merge several transitions emanating from source vertices in different orthogonal regions. The transitions entering a join vertex cannot have guards.
- *fork* vertices serve to split an incoming transition into two or more transitions terminating on orthogonal target vertices. The segments outgoing from a fork vertex must not have guards.
- *junction* vertices are semantic-free vertices that are used to chain together multiple transitions. They are used to construct compound transition paths between states. For example, a junction can be used to converge multiple incoming transitions into a single outgoing transition representing a shared transition path (this is known as a *merge*). Conversely, they can be used to split an incoming transition into multiple outgoing transition segments with different guard conditions. This realizes a *static conditional branch*. (In the latter case, outgoing transitions whose guard conditions evaluate to false are disabled. A predefined guard denoted “else” may be defined for at most one outgoing transition. This transition is enabled if all the guards labeling the other transitions are false.) Static conditional branches are distinct from dynamic conditional branches that are realized by choice vertices (described below).
- *choice* vertices which, when reached, result in the dynamic evaluation of the guards of its outgoing transitions. This realizes a *dynamic conditional branch*. It allows splitting of transitions into multiple outgoing paths such that the decision on which path to take may be

a function of the results of prior actions performed in the same run-to-completion step. If more than one of the guards evaluates to true, an arbitrary one is selected. If none of the guards evaluates to true, then the model is considered ill-formed. (To avoid this, it is recommended to define one outgoing transition with the predefined “else” guard for every choice vertex.) Choice vertices should be distinguished from static branch points that are based on junction points (described above).

PseudoState is a child of StateVertex.

Attributes

<i>kind</i>	Determines the precise type of the PseudoState and can be one of: <i>initial, deepHistory, shallowHistory, join, fork, junction, or choice.</i>
-------------	---

SignalEvent

A signal event represents the *reception* of a particular (asynchronous) signal. A signal event instance should not be confused with the action (e.g., send action) that generated it.

SignalEvent is a child of Event.

Associations

<i>signal</i>	The specific signal that is associated with this event.
---------------	---

SimpleState

A SimpleState is a state that does not have substates.

It is a child of State.

State

A state is an abstract metaclass that models a situation during which some (usually implicit) invariant condition holds. The invariant may represent a static situation such as an object waiting for some external event to occur. However, it can also model dynamic conditions such as the process of performing some activity (i.e., the model element under consideration enters the state when the activity commences and leaves it as soon as the activity is completed).

State is a child of StateVertex.

Associations

<i>deferrableEvent</i>	A list of events that are candidates to be retained by the state machine if they trigger no transitions out of the state (not consumed). A deferred event is retained until the statemachine reaches a state configuration where it is no longer deferred.
------------------------	--

2 UML Semantics

<i>entry</i>	An optional action that is executed whenever this state is entered regardless of the transition taken to reach the state. If defined, entry actions are always executed to completion prior to any internal activity or transitions performed within the state.
<i>exit</i>	An optional action that is executed whenever this state is exited regardless of which transition was taken out of the state. If defined, entry actions are always executed to completion only after all internal activities and transition actions have completed execution.
<i>doActivity</i>	An optional activity that is executed while being in the state. The execution starts when this state is entered, and stops either by itself, or when the state is exited, whichever comes first.
<i>internalTransition</i>	A set of transitions that, if triggered, occur without exiting or entering this state. Thus, they do not cause a state change. This means that the entry or exit condition of the State will not be invoked. These transitions can be taken even if the state machine is in one or more regions nested within this state.

StateMachine

A state machine is a specification that describes all possible behaviors of some dynamic model element. Behavior is modeled as a traversal of a graph of state nodes interconnected by one or more joined transition arcs that are triggered by the dispatching of series of event instances. During this traversal, the state machine executes a series of actions associated with various elements of the state machine.

StateMachine has a composition relationship to State, which represents the top-level state, and a set of transitions. This means that a state machine owns its transitions and its top state. All remaining states are transitively owned through the state containment hierarchy rooted in the top state. The association to ModelElement provides the context of the state machine. A common case of the context relation is where a state machine is used to specify the lifecycle of a classifier.

Associations

<i>context</i>	An association to the model element that whose behavior is specified by this state machine. A model element may have more than one state machine (although one is sufficient for most purposes). Each state machine is owned by exactly one model element.
<i>top</i>	Designates the top-level state that is the root of the state containment hierarchy. There is exactly one state in every state machine that is the top state.

transition The set of transitions owned by the state machine. Note that internal transitions are owned by their containing states and not by the state machine.

StateVertex

A StateVertex is an abstraction of a node in a statechart graph. In general, it can be the source or destination of any number of transitions.

StateVertex is a child of ModelElement.

Associations

outgoing Specifies the transitions departing from the vertex.

incoming Specifies the transitions entering the vertex.

container The composite state that contains this state vertex.

StubState

A stub state can appear within a submachine state and represents an actual subvertex contained within the referenced state machine. It can serve as a source or destination of transitions that connect a state vertex in the containing state machine with a subvertex in the referenced state machine.

StubState is a child of State.

Associations

referenceState Designates the referenced state as a pathname (a name formed by the concatenation of the name of a state and the successive names of all states that contain it, up to the top state).

SubmachineState

A submachine state is a syntactical convenience that facilitates reuse and modularity. It is a shorthand that implies a macro-like expansion by another state machine and is semantically equivalent to a composite state. The state machine that is inserted is called the *referenced* state machine while the state machine that contains the submachine state is called the *containing* state machine. The same state machine may be referenced more than once in the context of a single containing state machine. In effect, a submachine state represents a “call” to a state machine “subroutine” with one or more entry and exit points.

The entry and exit points are specified by stub states.

SubmachineState is a child of State.

2 UML Semantics

Associations

submachine The state machine that is to be substituted in place of the submachine state.

SynchState

A synch state is a vertex used for synchronizing the concurrent regions of a state machine. It is different from a state in the sense that it is not mapped to a boolean value (active, not active), but an integer. A synch state is used in conjunction with forks and joins to insure that one region leaves a particular state or states before another region can enter a particular state or states.

SynchState is a child of StateVertex.

Attributes

bound A positive integer or the value “unlimited” specifying the maximal count of the SynchState. The count is the difference between the number of times the incoming and outgoing transitions of the synch state are fired

TimeEvent

A TimeEvent models the expiration of a specific deadline. Note that the time of occurrence of a time event instance (i.e., the expiration of the deadline) is the same as the time of its reception. However, it is important to note that there may be a variable delay between the time of reception and the time of dispatching (e.g., due to queueing delays).

The expression specifying the deadline may be relative or absolute. If the time expression is relative and no explicit starting time is defined, then it is relative to the time of entry into the source state of the transition triggered by the event. In the latter case, the time event instance is generated only if the state machine is still in that state when the deadline expires.

Attributes

when Specifies the corresponding time deadline

Transition

A transition is a directed relationship between a source state vertex and a target state vertex. It may be part of a compound transition, which takes the state machine from one state configuration to another, representing the complete response of the state machine to a particular event instance.

Transition is a child of ModelElement.

Associations

<i>trigger</i>	Specifies the event that fires the transition. There can be at most one trigger per transition
<i>guard</i>	A boolean predicate that provides a fine-grained control over the firing of the transition. It must be true for the transition to be fired. It is evaluated at the time the event is dispatched. There can be at most one guard per transition.
<i>effect</i>	Specifies an optional action to be performed when the transition fires.
<i>source</i>	Designates the originating state vertex (state or pseudostate) of the transition.
<i>target</i>	Designates the target state vertex that is reached when the transition is taken.

2.12.3 Well-FormednessRules

The following well-formedness rules apply to the State Machines package.

CompositeState

- [1] A composite state can have at most one initial vertex

```
self.subvertex->select (v | v.ocIsKindOf(Pseudostate))->
    select(p : Pseudostate | p.kind = #initial)->size <= 1
```

- [2] A composite state can have at most one deep history vertex

```
self.subvertex->select (v | v.ocIsKindOf(Pseudostate))->
    select(p : Pseudostate | p.kind = #deepHistory)->size <= 1
```

- [3] A composite state can have at most one shallow history vertex

```
self.subvertex->select(v | v.ocIsKindOf(Pseudostate))->
    select(p : Pseudostate | p.kind = #shallowHistory)->size <= 1
```

- [4] There have to be at least two composite substates in a concurrent composite state

```
(self.isConcurrent) implies
    (self.subvertex->select
        (v | v.ocIsKindOf(CompositeState))->size >= 2)
```

- [5] A concurrent state can only have composite states as substates

```
(self.isConcurrent) implies
    self.subvertex->forAll(s | (s.ocIsKindOf(CompositeState)))
```

- [6] The substates of a composite state are part of only that composite state

```
self.subvertex->forall(s | (s.container->size = 1) and (s.container = self))
```

FinalState

- [1] A final state cannot have any outgoing transitions

```
self.outgoing->size = 0
```

Guard

- [1] A guard should not have side effects

```
self.transition->stateMachine->notEmpty implies  
  post: (self.transition.stateMachine->context =  
         self.transition.stateMachine->context@pre)
```

PseudoState

- [1] An initial vertex can have at most one outgoing transition and no incoming transitions

```
(self.kind = #initial) implies  
  ((self.outgoing->size <= 1) and (self.incoming->isEmpty))
```

- [2] History vertices can have at most one outgoing transition

```
((self.kind = #deepHistory) or (self.kind = #shallowHistory)) implies  
  (self.outgoing->size <= 1)
```

- [3] A join vertex must have at least two incoming transitions and exactly one outgoing transition.

```
(self.kind = #join) implies  
  ((self.outgoing->size = 1) and (self.incoming->size >= 2))
```

- [4] A fork vertex must have at least two outgoing transitions and exactly one incoming transition.

```
(self.kind = #fork) implies  
  ((self.incoming->size = 1) and (self.outgoing->size >= 2))
```

- [5] A junction vertex must have at least one incoming and one outgoing transition.

```
(self.kind = #junction) implies  
  ((self.incoming->size >= 1) and (self.outgoing->size >= 1))
```

- [6] A choice vertex must have at least one incoming and one outgoing transition.

```
(self.kind = #choice) implies  
  ((self.incoming->size >= 1) and (self.outgoing->size >= 1))
```

StateMachine

- [1] A StateMachine is aggregated within either a classifier or a behavioral feature.

```
self.context.oclIsKindOf(BehavioralFeature) or  
self.context.oclIsKindOf(Classifier)
```

- [2] A top state is always a composite.

```
self.top.oclIsTypeOf(CompositeState)
```

- [3] A top state cannot have any containing states

```
self.top.container->isEmpty
```

- [4] The top state cannot be the source of a transition.

```
(self.top.outgoing->isEmpty)
```

- [5] If a StateMachine describes a behavioral feature, it contains no triggers of type CallEvent, apart from the trigger on the initial transition (see OCL for Transition [8]).

```
self.context.oclIsKindOf(BehavioralFeature) implies  
self.transitions->reject(  
    source.oclIsKindOf(Pseudostate) and  
    source.oclAsType(Pseudostate).kind = #initial).trigger-  
>isEmpty
```

SynchState

- [1] The value of the bound attribute must be a positive integer, or unlimited.

```
(self.bound > 0) or (self.bound = unlimited)
```

- [2] All incoming transitions to a SynchState must come from the same region and all outgoing transitions from a SynchState must go to the same region.

SubmachineState

- [1] Only stub states allowed as substates of a submachine state.

```
self.subvertex->forAll (s | s.oclIsTypeOf(StubState))
```

- [2] Submachine states are never concurrent.

```
self.isConcurrent = false
```

Transition

- [1] A fork segment should not have guards or triggers.

```
self.source.oclIsKindOf(Pseudostate) implies  
((self.source.oclAsType(Pseudostate).kind = #fork) implies
```

2 UML Semantics

- ```
((self.guard->isEmpty) and (self.trigger->isEmpty)))
```
- [2] A join segment should not have guards or triggers.
- ```
self.target.oclIsKindOf(Pseudostate) implies
  ((self.target.oclAsType(Pseudostate).kind = #join) implies
    ((self.guard->isEmpty) and (self.trigger->isEmpty)))
```
- [3] A fork segment should always target a state.
- ```
(self.stateMachine->notEmpty) implies
self.source.oclIsKindOf(Pseudostate) implies
 ((self.source.oclAsType(Pseudostate).kind = #fork) implies
 (self.target.oclIsKindOf(State)))
```
- [4] A join segment should always originate from a state.
- ```
(self.stateMachine->notEmpty) implies
self.target.oclIsKindOf(Pseudostate) implies
  ((self.target.oclAsType(Pseudostate).kind = #join) implies
    (self.source.oclIsKindOf(State)))
```
- [5] Transitions outgoing pseudostates may not have a trigger.
- ```
self.source.oclIsKindOf(Pseudostate)
 implies (self.trigger->isEmpty)
```
- [6] Join segments should originate from orthogonal states.
- ```
self.target.oclIsKindOf(Pseudostate) implies
  ((self.target.oclAsType(Pseudostate).kind = #join) implies
    (self.source.container.isConcurrent))
```
- [7] Fork segments should target orthogonal states.
- ```
self.source.oclIsKindOf(Pseudostate) implies
 ((self.source.oclAsType(Pseudostate).kind = #fork) implies
 (self.target.container.isComposite))
```
- [8] An initial transition at the topmost level may have a trigger with the stereotype "create." An initial transition of a StateMachine modeling a behavioral feature has a CallEvent trigger associated with that BehavioralFeature. Apart from these cases, an initial transition never has a trigger.
- ```
self.source.oclIsKindOf(Pseudostate) implies
  ((self.source.oclAsType(Pseudostate).kind = #initial) implies
    (self.trigger->isEmpty or
      ((self.source.container = self.stateMachine.top) and
        (self.trigger.stereotype.name = 'create')) or
```

```

                                (self.stateMachine.context.oclIsKindOf(BehavioralFeature)
and
                                self.trigger.oclIsKindOf(CallEvent) and
                                (self.trigger.oclAsType(CallEvent).operation =
                                    self.stateMachine.context))
                                ))
self.source.oclIsKindOf(Pseudostate) implies
    ((self.source.kind = #initial) implies
        (self.trigger.isEmpty or
            ((self.source.container = self.StateMachine.top) and
                (self.trigger.stereotype.name = 'create')) or
            (self.StateMachine.context.oclIsKindOf(BehaviouralFeature)
and
                self.trigger.oclIsKindOf(CallEvent) and
                (self.trigger.operation =
                    self.StateMachine.context))
            ))
    ))
```

2.12.4 Semantics

This section describes the execution semantics of state machines. For convenience, the semantics are described in terms of the operations of a hypothetical machine that implements a state machine specification. This is for reference purposes only. Individual realizations are free to choose any form that achieves the same semantics.

In the general case, the key components of this hypothetical machine are:

- an *event queue* which holds incoming event instances until they are dispatched
- an *event dispatcher mechanism* that selects and de-queues event instances from the event queue for processing
- an *event processor* which processes dispatched event instances according to the general semantics of UML state machines and the specific form of the state machine in question. Because of that, this component is simply referred to as the “state machine” in the following text.

Although the intent is to define the semantics of state machines very precisely, there are a number of semantic variation points to allow for different semantic interpretations that might be required in different domains of application. These are clearly identified in the text.

The basic semantics of events, states, transitions, etc. are discussed first in separate subsections under the appropriate headings. The operation of the state machine as a whole are then described in the state machine subsection.

Event

Event instances are generated as a result of some action either within the system or in the environment surrounding the system. An event is then conveyed to one or more targets. The means by which event instances are transported to their destination depend on the type of action, the target, the properties of the communication medium, and numerous other factors. In some cases, this is practically instantaneous and completely reliable while in others it may involve variable transmission delays, loss of events, reordering, or duplication. No specific assumptions are made in this regard. This provides full flexibility for modeling different types of communication facilities.

An event is *received* when it is placed on the event queue of its target. An event is *dispatched* when it is dequeued from the event queue and delivered to the state machine for processing. At this point, it is referred to as the *current event*. Finally, it is *consumed* when event processing is completed. A consumed event is no longer available for processing. No assumptions are made about the time intervals between event reception, event dispatching, and consumption. This leaves open the possibility of different semantic models such as zero-time semantics.

Any parameter values associated with the current event are available to all actions directly caused by that event (transition actions, entry actions, etc.).

Event generalization may be defined explicitly by a signal taxonomy in the case of signal events, or implicitly defined by event expressions, as in time events.

State

Active states

A state can be active or inactive during execution. A state becomes *active* when it is entered as a result of some transition, and becomes *inactive* if it is exited as a result of a transition. A state can be exited and entered as a result of the same transition (e.g., self transition).

State entry and exit

Whenever a state is entered, it executes its entry action *before* any other action is executed. Conversely, whenever a state is exited, it executes its exit action as the final step prior to leaving the state.

If defined, the activity associated with a state is forked as a concurrent activity at the instant when the entry action of the state is completed. Upon exit, the activity is terminated before the exit action is executed.

Activity in state (do-activity)

The activity represents the execution of a sequence of actions, that occurs while the state machine is in the corresponding state. The activity starts executing upon entering the state, following the entry action. If the activity completes while the state is still active, it raises a completion event. In case where there is an outgoing completion transition (see below) the state will be exited. If the state is exited as a result of the firing of an outgoing transition before the completion of the activity, the activity is aborted prior to its completion.

Deferred events

A state may specify a set of event types that may be *deferred* in that state. An event instance that does not trigger any transitions in the current state, will not be dispatched if its type matches one of the types in the deferred event set of that state. Instead, it remains in the event queue while another non-deferred message is dispatched instead. This situation persists until a state is reached where either the event is no longer deferred or where the event triggers a transition.

CompositeState

Active state configurations

When dealing with composite and concurrent states, the simple term “current state” can be quite confusing. In a hierarchical state machine more than one state can be active at once. If the state machine is in a simple state that is contained in a composite state, then all the composite states that either directly or transitively contain the simple state are also active. Furthermore, since some of the composite states in this hierarchy may be concurrent, the current active “state” is actually represented by a tree of states starting with the single top state at the root down to individual simple states at the leaves. We refer to such a state tree as a *state configuration*.

Except during transition execution, the following invariants always apply to state configurations:

- If a composite state is active and not concurrent, exactly one of its substates is active.
- If the composite state is active and concurrent, all of its substates (regions) are active.

Entering a non-concurrent composite state

Upon entering a composite state, the following cases are differentiated:

- *Default entry*: Graphically, this is indicated by an incoming transition that terminates on the outside edge of the composite state. In this case, the default transition is taken. If there is a guard on the transition it must be enabled (true). (A disabled initial transition is an ill-defined execution state and its handling is not defined.) The entry action of the state is executed before the action associated with the initial transition.
- *Explicit entry*: If the transition goes to a substate of the composite state, then that substate becomes active and its entry code is executed after the execution of the entry code of the composite state. This rule applies recursively if the transition terminates on a transitively nested substate.
- *Shallow history entry*: If the transition terminates on a shallow history pseudostate, the active substate becomes the most recently active substate prior to this entry, unless the most recently active substate is the final state or if this is the first entry into this state. In the latter two cases, the *default history state* is entered. This is the substate that is target of the transition originating from the history pseudostate. (If no such transition is specified, the situation is illegal and its handling is not defined.) If the active substate determined by history is a composite state, then it proceeds with its default entry.

2 UML Semantics

- *Deep history entry*: The rule here is the same as for shallow history except that the rule is applied recursively to all levels in the active state configuration below this one.

Entering a concurrent composite state

Whenever a concurrent composite state is entered, each one of its concurrent substates (regions) is also entered, either by default or explicitly. If the transition terminates on the edge of the composite state, then all the regions are entered using default entry. If the transition explicitly enters one or more regions (in case of a fork), these regions are entered explicitly and the others by default.

Exiting non-concurrent state

When exiting from a composite state, the active substate is exited recursively. This means that the exit actions are executed in sequence starting with the innermost active state in the current state configuration.

Exiting a concurrent state

When exiting from a concurrent state, each of its regions is exited. After that, the exit actions of the regions are executed.

Deferred events

An event that is deferred in a composite state is automatically deferred in all directly or transitively nested substates.

FinalState

When the final state is entered, its containing composite state is *completed*, which means that it satisfies the completion condition. If the containing state is the top state, the entire state machine terminates, implying the termination of the entity associated with the state machine. If the state machine specifies the behavior of a classifier, it implies the “termination” of that instance.

SubmachineState

A submachine state is a convenience that does not introduce any additional dynamic semantics. It is semantically equivalent to a composite state and may have entry and exit actions, internal transitions, and activities.

Transitions

High-level transitions

Transitions originating from the boundary of composite states are called *high-level* or *group* transitions. If triggered, they result in exiting of all the substates of the composite state executing their exit actions starting with the innermost states in the active state configuration. Note that in terms of execution semantics, a high-level transition does not add specialized semantics, but rather reflects the semantics of exiting a composite state.

Compound transitions

A *compound transition* is a derived semantic concept, represents a “semantically complete” path made of one or more transitions, originating from a set of states (as opposed to pseudostate) and targeting a set of states. The transition execution semantics described below, refer to compound transitions.

In general, a compound transition is an acyclical unbroken chain of transitions joined via join, junction, choice, or fork pseudostates that define path from a set of source states (possibly a singleton) to a set of destination states, (possibly a singleton). For self-transitions, the same state acts as both the source and the destination set. A (simple) transition connecting two states is therefore a special common case of a compound transition.

The tail of a compound transition may have multiple transitions originating from a set of mutually orthogonal concurrent regions that are joined by a join point.

The head of a compound transition may have multiple transitions originating from a fork pseudostate targeted to a set of mutually orthogonal concurrent regions.

In a compound transition multiple outgoing transitions may emanate from a common *junction* point. In that case, only one of the outgoing transition whose guard is true is taken. If multiple transitions have guards that are true, a transition from this set is chosen. The algorithm for selecting such a transition is not specified. Note that in this case, the guards are evaluated before the compound transition is taken.

In a compound transition where multiple outgoing transitions emanate from a common *choice* point, the outgoing transition whose guard is true *at the time the choice point is reached*, will be taken. If multiple transitions have guards that are true, one transition from this set is chosen. The algorithm for selecting this transition is not specified. If no guards are true after the choice point has been reached, the model is ill formed.

Internal transitions

An internal transition executes without exiting or re-entering the state in which it is defined. This is true even if the state machine is in a nested state within this state.

Completion transitions and completion events

A *completion transition* is a transition without an explicit trigger, although it may have a guard defined. When all transition and entry actions and activities in the currently active state are completed, a *completion event* instance is generated. This event is the implicit trigger for a completion transition. The completion event is dispatched before any other queued events and has no associated parameters. For instance, a completion transition emanating from a concurrent composite state will be taken automatically as soon as all the concurrent regions have reached their final state.

If multiple completion transitions are defined for a state, then they should have mutually exclusive guard conditions.

Enabled (compound) transitions

A transition is *enabled* if and only if:

- All of its source states are in the active state configuration.
- The trigger of the transition is satisfied by the current event. An event instance *satisfies* a trigger if it matches the event specified by the trigger. In case of signal events, since signals are generalized concepts, a signal event satisfies a signal event associated with the same signal or a generalization of thereof.
- If there exists at least one full path from the source state configuration to either the target state configuration or to a dynamic choice point in which all guard conditions are true (transitions without guards are treated as if their guards are always true).

Since more than one transition may be enabled by the same event instance, being enabled is a necessary but not sufficient condition for the firing of a transition.

Guards

In a simple transition with a guard, the guard is evaluated before the transition is triggered.

In compound transitions involving multiple guards, all guards are evaluated before a transition is triggered, unless there are choice points along one or more of the paths. The order in which the guards are evaluated is not defined.

If there are choice points in a compound transition, only guards that precede the choice point are evaluated according to the above rule. Guards downstream of a choice point are evaluated if and when the choice point is reached (using the same rule as above). In other words, for guard evaluation, a choice point has the same effect as a state.

Guards should not include expressions causing side effects. Models that violate this are considered ill formed.

Transition execution sequence

Every transition, except for internal transitions, causes exiting of a source state, and entering of the target state. These two states, which may be composite, are designated as the *main source* and the *main target* of a transition.

The *least common ancestor* state of a transition is the lowest composite state that contains all the explicit source states and explicit target states of the compound transition. In case of junction segments, only the states related to the dynamically selected path are considered explicit targets (bypassed branches are not considered).

The main source is a direct substate of the least common ancestor that contains the explicit source states. The main target is a substate of the least common ancestor that contains the explicit target states.

Examples:

1. The common simple case: A transition t between two simple states $s1$ and $s2$, in a composite state s .

Here least common ancestor of t is s , the main source is $s1$ and the main target is $s2$.

2. A more esoteric case: An unstructured transition from one region to another.

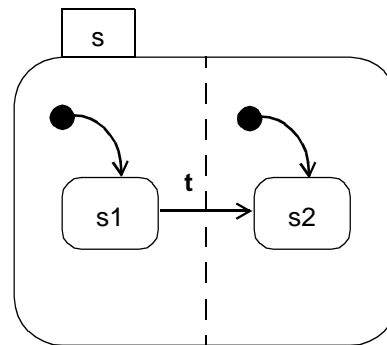

Figure 2-23 Unstructured transition among regions

Here least common ancestor of t is the container of s , the main source is $s1$ and the main target is $s2$

Once a transition is enabled and is selected to fire, the following steps are carried out in order:

- The main source state is properly exited.
- Actions are executed in sequence following their linear order along the segments of the transition: The closer the action to the source state, the earlier it is executed.
- If a choice point is encountered, the guards following that choice point are evaluated dynamically and a path whose guards are true is selected.
- The main target state is properly entered.

StateMachine

Event processing - run-to-completion step

Events are dispatched and processed by the state machine, one at a time. The order of dequeuing is not defined, leaving open the possibility of modeling different priority-based schemes.

The semantics of event processing is based on the *run-to-completion* assumption, interpreted as run-to-completion processing. Run-to-completion processing means that an event can only be dequeued and dispatched if the processing of the previous current event is fully completed.

Run-to-completion may be implemented in various ways. For active classes, it may be realized by an event-loop running in its own concurrent thread, and that reads events from a queue. For passive classes it may be implemented as a monitor.

The processing of a single event by a state machine is known as a *run-to-completion step*. Before commencing on a run-to-completion step, a state machine is in a stable state configuration with all actions (but not necessarily activities) completed. The same conditions apply after the run-to-completion step is completed. Thus, an event will never be processed while the state machine is in some intermediate and inconsistent situation. The *run-to-completion step* is the passage between two state configurations of the state machine.

The run-to-completion assumption simplifies the transition function of the state machine, since concurrency conflicts are avoided during the processing of event, allowing the state machine to safely complete its run-to-completion step.

When an event instance is dispatched, it may result in one or more transitions being enabled for firing. If no transition is enabled and the event is not in the deferred event list of the current state configuration, the event is discarded and the run-to-completion step is completed.

In the presence of concurrent states it is possible to fire multiple transitions as a result of the same event — as many as one transition in each concurrent state in the current state configuration. In case where one or more transitions are enabled, the state machine selects a subset and fires them. Which of the enabled transitions actually fire is determined by the transition selection algorithm described below. The order in which selected transitions fire is not defined.

Each orthogonal region in the active state configuration that is not decomposed into concurrent regions (i.e., “bottom-level” region) can fire at most one transition as a result of the current event. When all orthogonal regions have finished executing the transition, the current event instance is fully consumed, and the run-to-completion step is completed.

During a transition, a number of actions may be executed. If these actions are synchronous, then the transition step is not completed until the invoked objects complete their own run-to-completion steps.

An event instance can arrive at a state machine that is blocked in the middle of a run-to-completion step from some other object within the same thread, in a circular fashion. This event instance can be treated by orthogonal components of the state machine that are not frozen along transitions at that time.

Run-to-completion and concurrency

It is possible to define state machine semantics by allowing the run-to-completion steps to be applied concurrently to the orthogonal regions of a composite state, rather than to the whole state machine. This would allow the event serialization constraint to be relaxed. However, such semantics are quite subtle and difficult to implement. Therefore, the dynamic semantics defined in this document are based on the premise that a single run-to-completion step applies to the entire state machine and includes the concurrent steps taken by concurrent regions in the active state configuration.

In case of active objects, where each object has its own thread of execution, it is very important to clearly distinguish the notion of run to completion from the concept of thread pre-emption. Namely, run-to-completion event handling is performed by a thread that, in principle, *can* be pre-empted and its execution suspended in favor of another thread executing on the same processing node. (This is determined by the scheduling policy of the underlying thread

environment — no assumptions are made about this policy.) When the suspended thread is assigned processor time again, it resumes its event processing from the point of pre-emption and, eventually, completes its event processing.

Conflicting transitions

It was already noted that it is possible for more than one transition to be enabled within a state machine. If that happens, then such transitions may be in *conflict* with each other. For example, consider the case of two transitions originating from the same state, triggered by the same event, but with different guards. If that event occurs and both guard conditions are true, then only one transition will fire. In other words, in case of conflicting transitions, only one of them will fire in a single run-to-completion step.

Two transitions are said to conflict if they both exit the same state, or, more precisely, that the intersection of the set of states they exit is non-empty. Only transitions that occur in mutually orthogonal regions may be fired simultaneously. This constraint guarantees that the new active state configuration resulting from executing the set of transitions is well formed.

An internal transition in a state conflicts only with transitions that cause an exit from that state.

Firing priorities

In situations where there are conflicting transitions, the selection of which transitions will fire is based in part on an *implicit* priority. These priorities resolve some transition conflicts, but not all of them. The priorities of conflicting transitions are based on their relative position in the state hierarchy. By definition, a transition originating from a substate has higher priority than a conflicting transition originating from any of its containing states.

The priority of a transition is defined based on its source state. The priority of joined transitions is based on the priority of the transition with the most transitively nested source state.

In general, if t_1 is a transition whose source state is s_1 , and t_2 has source s_2 , then:

- If s_1 is a direct or transitively nested substate of s_2 , then t_1 has higher priority than t_2 .
- If s_1 and s_2 are not in the same state configuration, then there is no priority difference between t_1 and t_2 .

Transition selection algorithm

The set of transitions that will fire is a maximal set of transitions that satisfies the following conditions:

- All transitions in the set are enabled.
- There are no conflicting transitions within the set.
- There is no transition outside the set that has higher priority than a transition in the set (that is, enabled transitions with highest priorities are in the set while conflicting transitions with lower priorities are left out).

This can be easily implemented by a greedy selection algorithm, with a straightforward traversal of the active state configuration. States in the active state configuration are traversed starting with the innermost nested simple states and working outwards toward the top state. For

each state at a given level, all originating transitions are evaluated to determine if they are enabled. This traversal guarantees that the priority principle is not violated. The only non-trivial issue is resolving transition conflicts across orthogonal states on all levels. This is resolved by terminating the search in each orthogonal state once a transition inside any one of its components is fired.

Synch States

Synch states provide a means of synchronizing the execution of two concurrent regions. Specifically, a synch state has incoming transitions from a fork (or forks) in one region, the *source* region, and outgoing transitions to a join (or joins) in another, the *target* region. These forks and joins are called *synchronization* forks and joins. The synch state itself is contained by the least common ancestor of the two regions being synchronized. The synchronized regions do not need to be siblings in state decomposition, but they must have a common ancestor state.

When the source region reaches a synchronization fork, the target states of that fork become active, including the synch state. Activation of the synch state is an indication that the source region has completed some activity. This region can continue performing its remaining activities in parallel. When the target region reaches the corresponding synchronization join, it is prevented from continuing unless all the states leading into the synchronization join are active, including the synch states.

A synch state may have multiple incoming and outgoing transitions, used for multiple synchronization points in each region. Alternatively, it may have single incoming and outgoing transitions where the incoming transition is fired multiple times before the outgoing one is fired. To support these applications, synch states keep count of the difference between the number of times their incoming and outgoing transitions are fired. When an incoming transition is fired, the count is incremented by one, unless its value is equal to the value defined in the *bound* attribute. In that case, the count is not incremented. When an outgoing transition is fired, the count is decremented by one. An outgoing transition may fire only if the count is greater than zero, which prevents the count from becoming negative. The count is automatically set to zero when its container state is exited.

The bound attribute is for limiting the number of times outgoing transitions fire from a synch state. For a state, to realize the equivalent of a binary semaphore, the bound should be set to one. In this case multiple incoming transitions may fire before the outgoing transition does, whereupon the outgoing transition can only fire once.

StubStates

Stub states are pseudostates signifying either entry points to or exit points from a submachine. Since a submachine is encapsulated and represented as a submachine state, multi-level (“deep”) transitions may logically connect states in separate state machines. This is facilitated by stub state, representing real states in a referenced machine to or from transitions in the referencing machine are incoming/outgoing. stub states are therefore can only be defined within a submachine state, and are the only potential subvertices of a submachine state.

2.12.5 Notes

Protocol State Machines

One application area of state machines is in specifying object protocols, also known as object life cycles. A 'protocol state machine' for a class defines the order (i.e. sequence) in which the operations of that Class can be invoked. The behavior of each of these operations is defined by an associated method, rather than through action expressions on transitions.

A transition in a protocol state machine has as its trigger a call event that references an operation of the class, and an empty action sequence. Such a transition indicates that if the call event occurs when an object of the class is in the source state of the transition and the guard on the transition is true, then the method associated with the operation of the call event will be executed (if one exists), and the object will enter the target state. Semantically, the invocation of the method does not lead to a new call event being raised.

If a call event arrives when the state machine is not in an appropriate state to handle the event, the event is discarded, conform the general RTC semantics. Strictly speaking, from the caller's point of view this means that the call is completed. If instead the semantics are required that the caller should 'hang' (potentially infinitely) if the receiver's state machine is not able to process the call event immediately, then the event must be deferred explicitly. This can be done for all call events in a protocol state machine by deferring them at a superstate level.

In any practical application, a protocol state machine is made up exclusively of 'protocol' transitions, and the entry and exit actions of its states are empty (i.e. no action specifications exist other than for the methods). However, formally it is not prohibited to mix this kind of transition with transitions with explicit actions (as it does not seem worth the effort to prohibit this, and there may be some applications that might benefit from 'mixing').

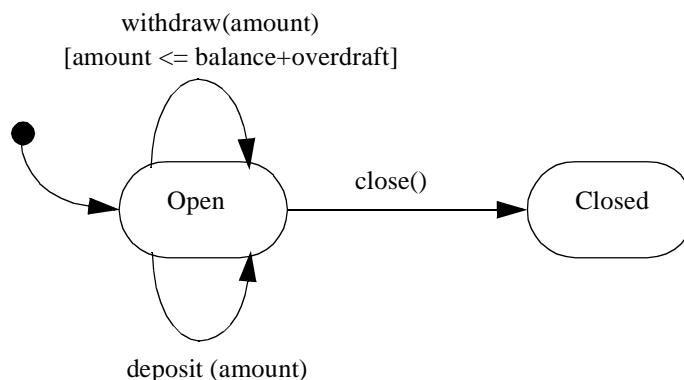

Figure 2-24 Example of a Protocol State Machine for a Class 'Account'.

2 UML Semantics

Example: Modeling Class Behavior

In the software that is implemented as a result of a state modeling design, the state machine may or may not be actually visible in the (generated or hand-crafted) code. The state machine will not be visible if there is some kind of run-time system that supports state machine behavior. In the more general case, however, the software code will contain specific statements that implement the state machine behavior.

A C++ example is shown below:

```
class bankAccount {  
    private:  
        int balance;  
    public:  
        void deposit (amount) {  
            if (balance > 0)  
                balance = balance + amount; // no change  
            else  
                balance = balance + amount - 1; // transaction fee  
        }  
        void withdrawal (amount) {  
            if (balance > 0)  
                balance = balance - amount;  
        }  
    }  
}
```

In the above example, the class has an abstract state manifested by the balance attribute, controlling the behavior of the class. This is modeled by the state machine in Figure 2-25.

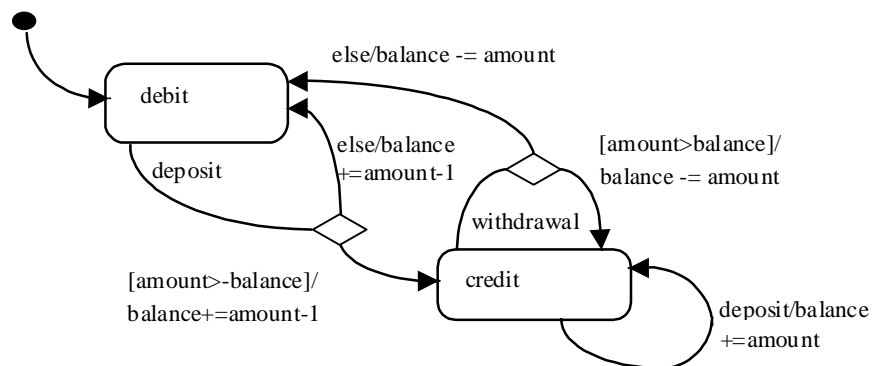

Figure 2-25 State Machine for Modeling Class Behavior

Example: State machine refinement

Note – The following discussion provides some potentially useful heuristics on how state machines can be refined. These techniques are all based on practical experience. However, readers are reminded that this topic is still the subject of research, and that it is likely that other approaches may be defined either now or in the future.

Since state machines describe behaviors of generalizable elements, primarily classes, state machine refinement is used capture the relationships between the corresponding state machines. State machines use refinement in three different mappings, specified by the mapping attribute of the refinement meta-class. The mappings are refinement, substitution, and deletion.

To illustrate state machine refinement, consider the following example where one state machine attached to a class denoted ‘Supplier,’ is refined by another state machine attached to a class denoted as ‘Client.’

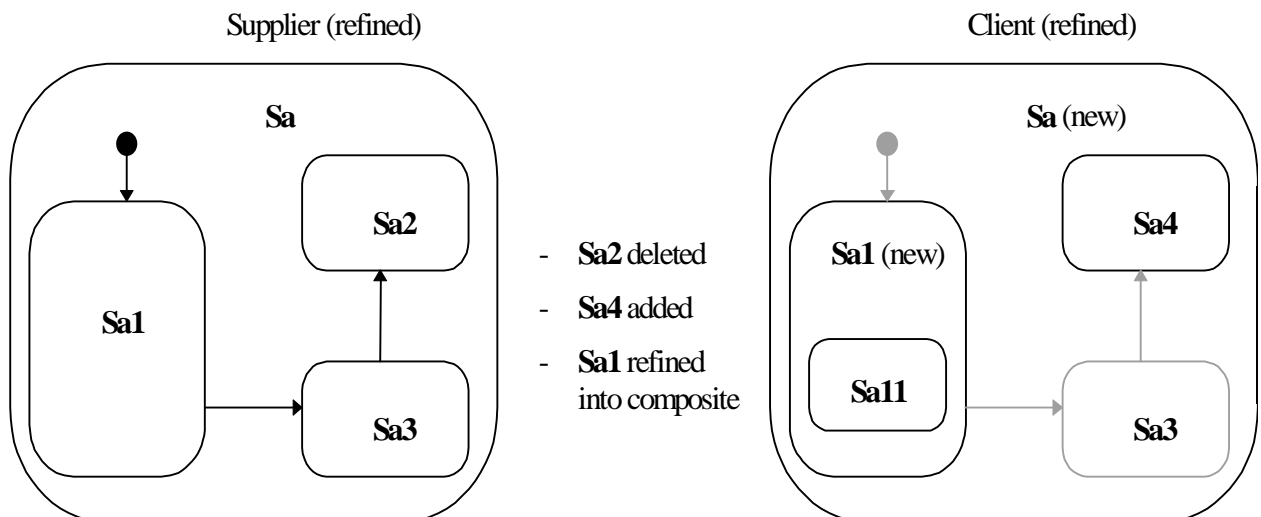

Figure 2-26 State Machine Refinement Example

In the example above, the client state (Sa(new)) in the subclass substitutes the simple substate (Sa1) by a composite substate (Sa1(new)). This new composite substate has a component substate (Sa11). Furthermore, the new version of Sa1 deletes the substate Sa2 and also adds a new substate Sa4. Substate Sa3 is inherited and is therefore common to both versions of Sa. For clarity, we have used a gray shading to identify components that have been inherited from the original. (This is for illustration purposes and is not intended as a notational recommendation.)

It is important to note that state machine refinement as defined here does not specify or favor any specific policy of state machine refinement. Instead, it simply provides a flexible mechanism that allows subtyping, (behavioral compatibility), inheritance (implementation reuse), or general refinement policies.

We provide a brief discussion of potentially useful policies that can be implemented with the state machine refinement mechanism.

Subtyping

The refinement policy for subtyping is based on the rationale that the subtype preserves the pre/post condition relationships of applying events/operations on the type, as specified by the state machine. The pre/post conditions are realized by the states, and the relationships are realized by the transitions. Preserving pre/post conditions guarantee the substitutability principle.

States and transitions are only added, not deleted. Refinement is interpreted as follows:

- A refined state has the same outgoing transitions, but may add others, and a different set of incoming transitions. It may have a bigger set of substates, and it may change its concurrency property from false to true.
- A refined transition may go to a new target state which is a substate of the state specified in the base class. This comes to guarantee the post condition specified by the base class.
- A refined guard has the same guard condition, but may add disjunctions. This guarantees that pre-conditions are weakened rather than strengthened.
- A refined action sequence contains the same actions (in the same sequence), but may have additional actions. The added actions should not hinder the invariant represented by the target state of the transition.

Strict Inheritance

The rationale behind this policy is to encourage reuse of implementation rather than preserving behavior. Since most implementation environment utilize strict inheritance (i.e. features can be replaced or added, but not deleted), the inheritance policy follows this line by disabling refinements which may lead to non-strict inheritance once the state machine is implemented.

States and transitions can be added. Refinement is interpreted as follows:

- A refined state has some of the same incoming transitions (i.e., drop some, add some) but a greater or bigger set of outgoing transitions. It may have more substates, and may change its concurrency attribute.
- A refined transition may go to a new target state but should have the same source.
- A refined guard may have a different guard condition.
- A refined action sequence contains some of the same actions (in the same sequence), and may have additional actions.

General Refinement

In this most general case, states and transitions can be added and deleted (i.e., 'null' refinements). Refinement is interpreted without constraints (i.e., there are no formal requirements on the properties and relationships of the refined state machine element and the refining element):

- A refined state may have different outgoing and incoming transitions (i.e., drop all, add some).
- A refined transition may leave from a different source and go to a new target state.
- A refined guard may have a different guard condition.

- A refined action sequence need not contain the same actions (or it may change their sequence), and may have additional actions.

The refinement of the composite state in the example above is an illustration of general refinement.

It should be noted that if a type has multiple supertype relationships in the structural model, then the default state machine for the type consists of all the state machines of its supertypes as orthogonal state machine regions. This may be explicitly overridden through refinement if required.

Comparison to classical statecharts

The major difference between classical (Harel) statecharts and object state machines result from the external context of the state machine. Object state machines, such as ROOMcharts, primarily come to represent behavior of a type. Classical statechart specify behaviors of processes. The following list of differences result from the above rationale:

- Events carry parameters, rather than being primitive signals.
- Call events (operation triggers) are supported to model behaviors of types.
- Event conjunction is not supported, and the semantics is given in respect to a single event dispatch, to better match the type context as opposed to a general system context.
- Classical statecharts have an elaborated set of predefined actions, conditions and events which are not mandated by object state machines, such as entered(s), exited(s), true(condition), tr!(c) (make true), fs!(c).
- Operations are not broadcast but can be directed to an object-set.
- The notion of activities (processes) does not exist in object state machines. Therefore all predefined actions and events that deal with activities are not supported, as well as the relationships between states and activities.
- Transition compositions are constrained for practical reasons. In classical statecharts any composition of pseudostates, simple transitions, guards and labels is allowed.
- Object state machine support the notion of synchronous communication between state machines.
- Actions on transitions are executed in their given order.
- Classical statecharts do not support dynamic choice points.
- Classical statecharts are based on the zero-time assumption, meaning transitions take zero time to execute. The whole system execution is based on synchronous steps where each step produces new events that will be processed at the next step. In object-oriented state machines, these assumptions are relaxed and replaced with these of software execution model, based on threads of execution and that execution of actions may take time.

2 UML Semantics

2.13 Activity Graphs

2.13.1 Overview

Activity graphs define an extended view of the State Machine package. State machines and activity graphs are both essentially state transition systems, and share many metamodel elements. This section describes the concepts in the State Machine package that are specific to activity graphs. It should be noted that the activity graphs extension has few semantics of its own. It should be understood in the context of the State Machine package, including its dependencies on the Foundation package and the Common Behavior package.

An activity graph is a special case of a state machine that is used to model processes involving one or more classifiers. Its primary focus is on the sequence and conditions for the actions that are taken, rather than on which classifiers perform those actions. Most of the states in such a graph are action states that represent atomic actions (i.e., states that invoke actions and then wait for their completion). Transitions into action states are triggered by events, which can be

- the completion of a previous action state (completion events),
- the availability of an object in a certain state,
- the occurrence of a signal, or
- the satisfaction of some condition.

By defining a small set of additional subtypes to the basic state machine concepts, the well-formedness of activity graphs can be defined formally, and subsequently mapped to the dynamic semantics of state machines. In addition, the activity specific subtypes eliminate ambiguities that might otherwise arise in the interchange of activity graphs between tools.

2.13.2 Abstract Syntax

The abstract syntax for activity graphs is expressed in graphic notation in Figure 2-28 on page 2-160.

2 UML Semantics

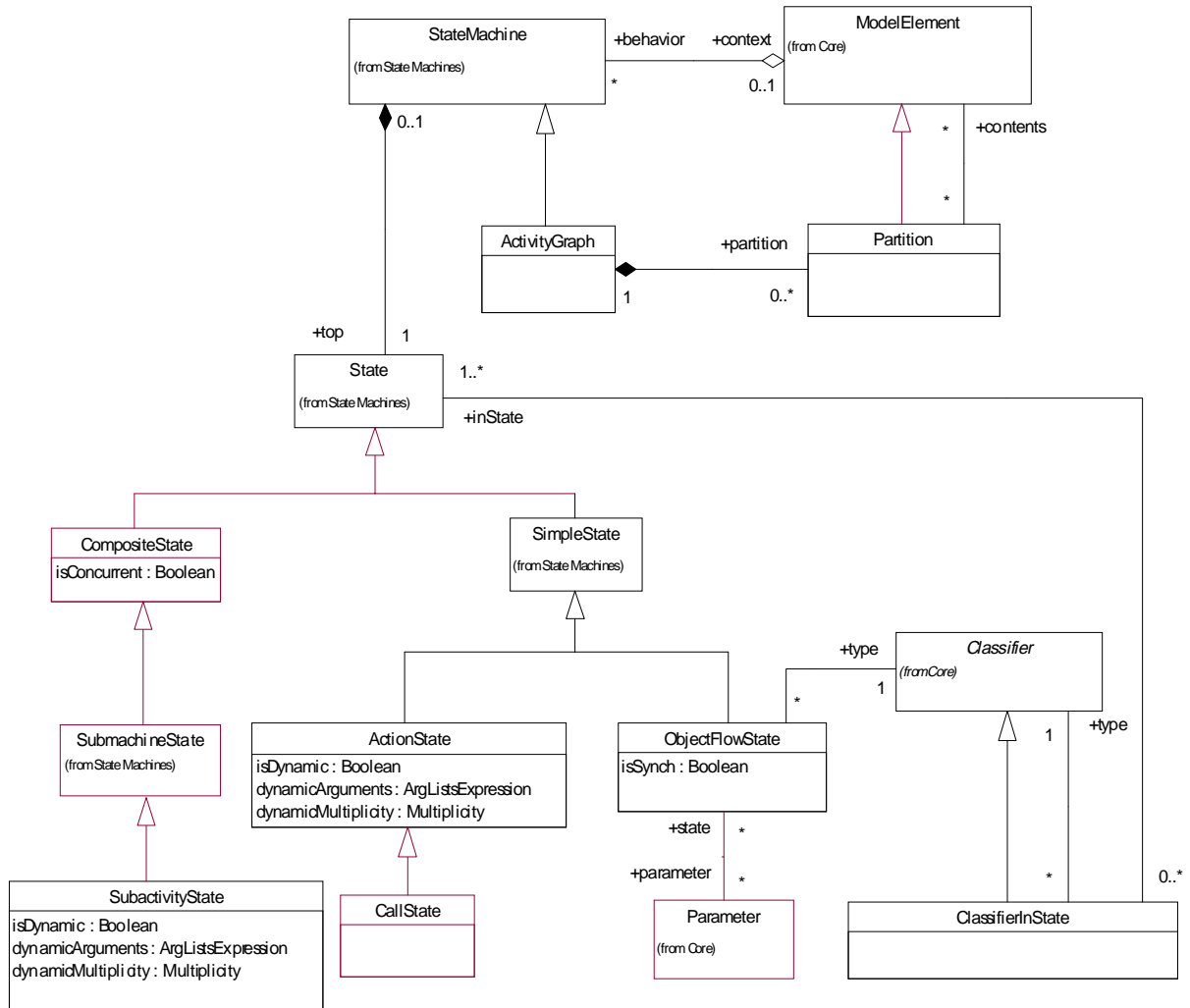

Figure 2-28 Activity Graphs

ActivityGraph

An activity graph is a special case of a state machine that defines a computational process in terms of the control-flow and object-flow among its constituent actions. It does not extend the semantics of state machines in a major way but it does define shorthand forms that are convenient for modeling control-flow and object-flow in computational and organizational processes.

The primary basis for activity graphs is to describe the states of an activity or process involving one or more classifiers. Activity graphs can be attached to packages, classifiers (including use cases) and behavioral features. As in any state machine, if an outgoing transition is not

explicitly triggered by an event then it is implicitly triggered by the completion of the contained actions. A subactivity state represents a nested activity that has some duration and internally consists of a set of actions or more subactivities. That is, a subactivity state is a “hierarchical action” with an embedded activity subgraph that ultimately resolves to individual actions.

Junctions, forks, joins, and synchs may be included to model decisions and concurrent activity.

Activity graphs include the concept of Partitions to organize states according to various criteria, such as the real-world organization responsible for their performance.

Activity graphing can be applied to organizational modeling for business process engineering and workflow modeling. In this context, events often originate from inside the system, such as the finishing of a task, but also from outside the system, such as a customer call. Activity graphs can also be applied to system modeling to specify the dynamics of operations and system level processes when a full interaction model is not needed.

Associations

partition A set of Partitions each of which contains some of the model elements of the model.

ActionState

An action state represents the execution of an atomic action, typically the invocation of an operation.

An action state is a simple state with an entry action whose only exit transition is triggered by the implicit event of completing the execution of the entry action. The state therefore corresponds to the execution of the entry action itself and the outgoing transition is activated as soon as the action has completed its execution.

An ActionState may perform more than one action as part of its entry action. An action state may not have an exit action, do activity, or internal transitions.

Attributes

dynamicArguments An ArgListsExpression that determines at runtime the number of parallel executions of the actions of the state. The value must be a set of lists of objects, each list serving as arguments for one execution. This attribute is ignored if the *isDynamic* attribute is false.

dynamicMultiplicity A Multiplicity limiting the number of parallel executions of the actions of state. This attribute is ignored if the *isDynamic* attribute is false.

isDynamic A boolean value specifying whether the state's actions might be executed concurrently. It is used in conjunction with the *dynamicArguments* attribute.

2 UML Semantics

Associations

entry (Inherited from State) Specifies the invoked actions.

CallState

A call state is an action state that has exactly one call action as its entry action. It is useful in object flow modeling to reduce notational ambiguity over which action is taking input or providing output.

ClassifierInState

A classifier-in-state characterizes instances of a given classifier that are in a particular state or states. In an activity graph, it may be used to specify input and/or output to an action through an object flow state.

ClassifierInState is a child of Classifier and may be used in static structural models and collaborations (e.g., it can be used to show associations that are only relevant when objects of a class are in a given state).

Associations

type Designates a classifier that characterizes instances.

inState Designates a state that characterizes instances. The state must be a valid state of the corresponding classifier. This may have multiple states when referring to an object in orthogonal states.

ObjectFlowState

An object flow state defines an object flow between actions in an activity graph. It signifies the availability of an instance of a classifier, possibly in a particular state, usually as the result of an operation. An instance of a particular class, possibly in a particular state, is available when an object flow state is occupied.

The generation of an object by an action in an action state may be modeled by an object flow state that is triggered by the completion of the action state. The use of the object in a subsequent action state may be modeled by connecting the output transition of the object flow state as an input transition to the action state. Generally each action places the object in a different state that is modeled as a distinct object flow state.

Attributes

isSynch A boolean value indicating whether an object flow state is used as a synch state.

Associations

<i>type</i>	Designates a classifier that specifies the classifier of the object. It may be a classifier-in-state to specify the state and classifier of the object.
<i>parameter</i>	Designates parameters which provide the object as output or take it as input.

Stereotypes

«signalflow»	Signalflow is a stereotype of ObjectFlowState with a Signal as its type.
--------------	--

Partition

A partition is a mechanism for dividing the states of an activity graph into groups. Partitions often correspond to organizational units in a business model. They may be used to allocate characteristics or resources among the states of an activity graph.

Associations

<i>contents</i>	Specifies the states that belong to the partition. They need not constitute a nested region.
-----------------	--

It should be noted that Partitions do not impact the dynamic semantics of the model but they help to allocate properties and actions for various purposes.

SubactivityState

A subactivity state represents the execution of a non-atomic sequence of steps that has some duration (i.e., internally it consists of a set of actions and possibly waiting for events). That is, a subactivity state is a “hierarchical action,” where an associated subactivity graph is executed.

A subactivity state is a submachine state that executes a nested activity graph. When an input transition to the subactivity state is triggered, execution begins with the initial state of the nested activity graph. The outgoing transitions of a subactivity state are enabled when the final state of the nested activity graph is reached (i.e., when it completes its execution), or when the trigger events occur on the transitions.

The semantics of a subactivity state are equivalent to the model obtained by statically substituting the contents of the nested graph as a composite state replacing the subactivity state.

2 UML Semantics

Attributes

<i>dynamicArguments</i>	An ArgListsExpression that determines the number of parallel executions of the submachines of the state. The value must be a set of lists of objects, each list serving as arguments for one execution. This attribute is ignored if the <i>isDynamic</i> attribute is false.
<i>dynamicMultiplicity</i>	A Multiplicity limiting the number of parallel executions of the actions of state. This attribute is ignored if the <i>isDynamic</i> attribute is false.
<i>isDynamic</i>	A boolean value specifying whether the state's submachines might be executed concurrently. It is used in conjunction with the <i>dynamicArguments</i> attribute.

Associations

<i>submachine</i>	(Inherited from SubmachineState) This designates an activity graph that is conceptually nested within the subactivity state. The subactivity state is conceptually equivalent to a composite state whose contents are the states of the nested activity graph. The nested activity graph must have an initial state and a final state.
-------------------	--

2.13.3 Well-Formedness Rules

ActivityGraph

- [1] An ActivityGraph specifies the dynamics of
- (i) a Package, or
 - (ii) a Classifier (including UseCase), or
 - (iii) a BehavioralFeature.

```
(self.context.ocIsTypeOf(Package) xor
self.context.ocIsKindOf(Classifier) xor
self.context.ocIsKindOf(BehavioralFeature))
```

ActionState

- [1] An action state has a non-empty entry action.
- ```
self.entry->size > 0
```
- [2] An action state does not have an internal transition, exit action, or a do activity.
- ```
self.internalTransition->size = 0 and self.exit->size = 0 and
self.doActivity->size = 0
```
- [3] Transitions originating from an action state have no trigger event.

```
self.outgoing->forall(trigger->size = 0)
```

CallState

[1] The entry action of a call state is a single call action.

```
self.entry->size = 1 and self.entry.oclIsKindOf(CallAction)
```

ObjectFlowState

[1] Parameters of an object flow state must have a type and direction compatible with classifier or classifier-in-state of the object flow state.

```
let osftype : Classifier =
    (if self.type.IsKindOf(ClassifierInState)
     then self.type.type else self.type);
self.parameter.forAll(
    type = osftype
    or (parameter.kind = #in
        and osftype.allSupertypes->includes(type))
    or ((parameter.kind = #out or parameter.kind = #return)
        and type.allSupertypes->includes(osftype))
    or (parameter.kind = #inout
        and ( osftype.allSupertypes->includes(type)
            or type.allSupertypes->includes(osftype))))
```

[2] Downstream states have entry actions that accept input conforming to the type of the classifier or classifier-in-state. The entry actions use the input parameters of the object flow state. Valid downstream states are calculated by traversing outgoing transitions transitively, skipping pseudo states, and entering and exiting subactivity states, looking for regular states. If the object flow state has no parameters, then the target of downstream actions must conform to the type of the classifier or classifier-in-state.

```
self.allnextleafstates.size > 0 and
    self.allnextleafstates.forAll(self.isinputaction(entry))
```

[3] Upstream states have entry actions that provide output or return values conforming to the type of the classifier or classifier-in-state. The entry actions use the output or return parameters of the object flow state. Valid upstream states are calculated by traversing incoming transitions transitively, skipping pseudo states, entering and exiting subactivity states, looking for regular states.

```
self.allpreviousleafstates.size > 0 and
    self.allpreviousleafstates.forAll(self.isoutputaction(entry))
```

2 UML Semantics

PseudoState

[1] In activity graphs, transitions incoming to (and outgoing from) join and fork pseudostates have as sources (targets) any state vertex. That is, joins and forks are syntactically not restricted to be used in combination with composite states, as is the case in state machines.

```
self.stateMachine.oclIsTypeOf(ActivityGraph) implies
  ((self.kind = #join or self.kind = #fork) implies
    (self.incoming->forAll(source.oclIsKindOf(State) or
      source.oclIsTypeOf(PseudoState)) and
    (self.outgoing->forAll(source.oclIsKindOf(State) or
      source.oclIsTypeOf(PseudoState))))))
```

[2] All of the paths leaving a fork must eventually merge in a subsequent join in the model. Furthermore, multiple layers of forks and joins must be well nested, with the exception of forks and joins leading to or from synch state. Therefore the concurrency structure of an activity graph is in fact equally restrictive as that of an ordinary state machine, even though the composite states need not be explicit.

SubactivityState

[1] A subactivity state is a submachine state that is linked to an activity graph.

```
self.submachine.oclIsKindOf(ActivityGraph)
```

2.13.4 Semantics

ActivityGraph

The dynamic semantics of activity graphs can be expressed in terms of state machines. This means that the process structure of activities formally must be equivalent to orthogonal regions (in composite states). That is, transitions crossing between parallel paths (or threads) are not allowed, except for transitions used with synch states. As such, an activity specification that contains ‘unconstrained parallelism’ as is used in general activity graphs is considered ‘incomplete’ in terms of UML.

All events that are not relevant in a state must be deferred so they are consumed when they become relevant. This is facilitated by the general deferral mechanism of state machines.

ActionState

As soon as the incoming transition of an ActionState is triggered, its entry action starts executing. Once the entry action has finished executing, the action is considered completed. When the action is complete then the outgoing transition is enabled.

The isDynamic attribute of an action state determines whether multiple invocations of state might be executed concurrently, depending on runtime information. This means that the normal activities of an action state, namely its actions, may execute multiple times in parallel. If

isDynamic is true, then the dynamicArguments attribute is evaluated at the time the state is entered. The size of the resulting set determines the number of parallel executions of the state. Each element of the set is a list, which is used as arguments for an execution. These arguments can be referred to within actions (e.g. by “object[i]” denoting the *i*th object in a list). If the isDynamic attribute is false, dynamicArguments is ignored. If the dynamicArguments expression evaluates to the empty set, then the state behaves as if it had no actions. It is an error if the dynamicArguments expression evaluates to a set with fewer or more elements than the number allowed by the dynamicMultiplicity attribute. The behavior is not defined in this case.

Dynamic states may be nested. In this case, you can't access the outer set of arguments in the inner nesting. If this should be necessary, arguments can be passed explicitly from the outer to the inner dynamic state.

ObjectFlowState

The activation of an object flow state signifies that an instance of the associated classifier is available, perhaps in a specified state (i.e., a state change has occurred as a result of a previous operation). This may enable a subsequent action state that requires the instance as input. As with all states in activity graphs, if the object flow state leads into a join pseudostate, then the object flow state remains activated until the other predecessors of the join have completed.

Unless there is an explicit ‘fork’ that creates orthogonal object states, only one of an object flow state’s outgoing transitions will fire as determined by the guards of the transitions. The invocation of the action state may result in a state change of the object, resulting in a new object flow state.

An object flow state may specify the parameter of an operation that provides its object as output, and the parameter of an operation that takes its object as input. The operations must be called in actions of states immediately preceding and succeeding the object flow state, respectively, although pseudostates, final states, synch states, and stub states may be interposed between the object flow state and the acting state. For example, an object flow state may transition to a subactivity state, which means at runtime the object is passed as input to the first state after the initial state of the subactivity graph. If no parameter is specified to take the flowing object as input, then it is used as an action target instead. Call actions are particularly suited to be used in conjunction with this technique because they invoke exactly one operation.

Object flow states may be used as synch states, indicated by the isSynch attribute being set to true. In this case, outgoing transitions can fire only if an object has arrived on the incoming transitions. Instead of a count, the state keeps a queue of objects as they arrive on the incoming transitions. These objects are pulled from the queue in FIFO fashion as outgoing transitions are fired. No outgoing transitions can fire if the queue is empty. All objects in the queue conform to the classifier and state specified by the object flow state. The queue is not bounded as the count may be in synch states.

For applications requiring that actions or activities bring about an event as their result, use an object flow state with a signal as a classifier. This means the action or activity must return an instance of a signal. For multiple resulting events, transition the action or activity to a fork, and target the fork transitions at multiple object flow states.

2 UML Semantics

SubactivityState

The `isDynamic`, `dynamicArguments`, and `dynamicMultiplicity` attributes of a subactivity state have a similar meaning to the same attributes of action states. They provide for executing the submachine of the subactivity state multiple times in parallel. See semantics of `ActionState`.

Transition

In activity graphs, transitions outgoing from forks may have guards. This means the region initiated by a fork transition might not start, and therefore not be required to complete at the corresponding join. Forks and joins must be well-nested in the model to use this feature (see rule #2 for `PseudoState` in Activity Graphs). The following mapping shows the state machine meaning for such an activity graph:

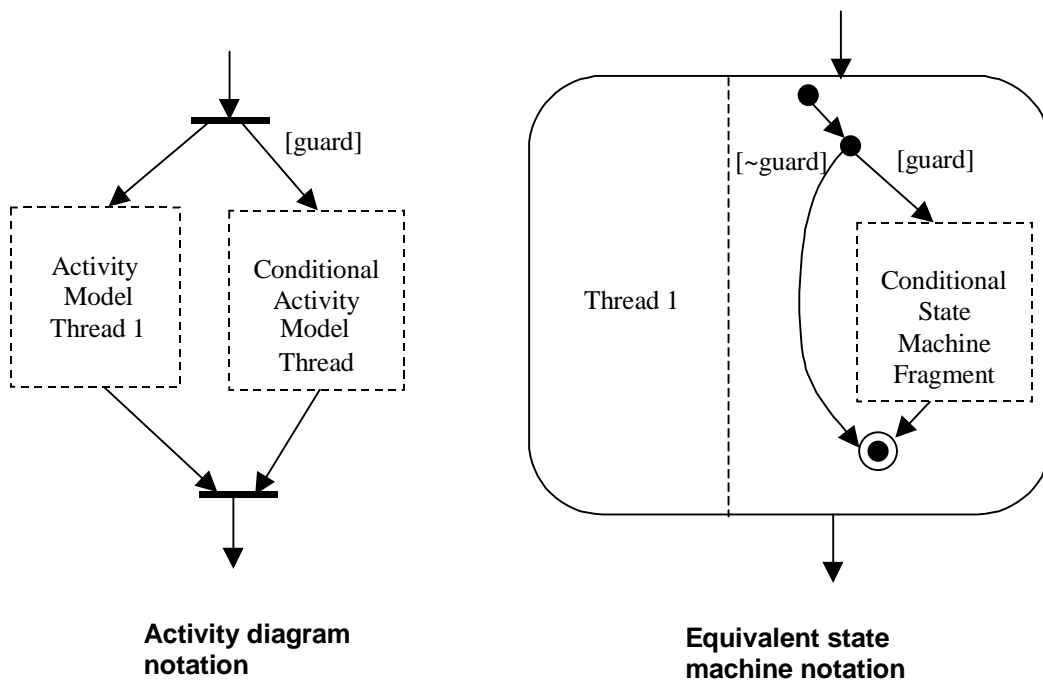

If a conditional region synchronizes with another region using a synch state, and the condition fails, then these synch states have their counts set to infinity to prevent other regions from deadlocking.

2.13.5 Notes

Object flow states in activity graphs are a specialization of the general dataflow aspect of process models. Object-flow activity graphs extend the semantics of standard dataflow relationships in three areas:

1. The operations in action states in activity graphs are operations of classes or types (e.g., 'Trade' or 'OrderEntryClerk'). They are not hierarchical 'functions' operating on a dataflow.

2.13 Activity Graphs

2. The 'contents' of object flow states are typed. They are not unstructured data definitions as in data stores.
3. The state of the object flowing as input and output between operations may be defined explicitly. The event of the availability of an object in a specific state may form a trigger for the operation that requires the object as input. Object flow states are not necessarily stateless as are data stores.

2 UML Semantics

Part 4 - General Mechanisms

This section defines the mechanisms of general applicability to models. This version of UML contains one general mechanisms package, Model Management. The Model Management package specifies how model elements are organized into models, packages, and subsystems.

2.14 Model Management

2.14.1 Overview

The Model Management package is dependent on the Foundation package. It defines Model, Package, and Subsystem, which all serve mainly as grouping units for other ModelElements.

Packages are used within a Model to group ModelElements. A Subsystem is a special kind of Package that represents a behavioral unit in the physical system, and hence in the model.

In this section it is necessary to clearly distinguish between the *physical system* being modeled (i.e., the subject of the model) and the subsystem elements that represent the physical system in the model. For this reason, we consistently use the term *physical system* when we want to indicate the former, and the terms *subsystem* when we want to indicate the latter. An example of a physical system is a credit card service, which includes software, hardware and wetware (people). The UML model for this physical system might consist of a top-level subsystem called CreditCardService which is decomposed into subsystems for Authorization, Credit, and Billing. An analogy with the construction of houses would be that the house would correspond to the physical system, while a blueprint would correspond to a model, and an element used in a blue print would correspond to a model element.

The following sections describe the abstract syntax, well-formedness rules, and semantics of the Model Management package.

2.14.2 Abstract Syntax

The abstract syntax for the Model Management package is expressed in graphic notation in Figure 2-29.

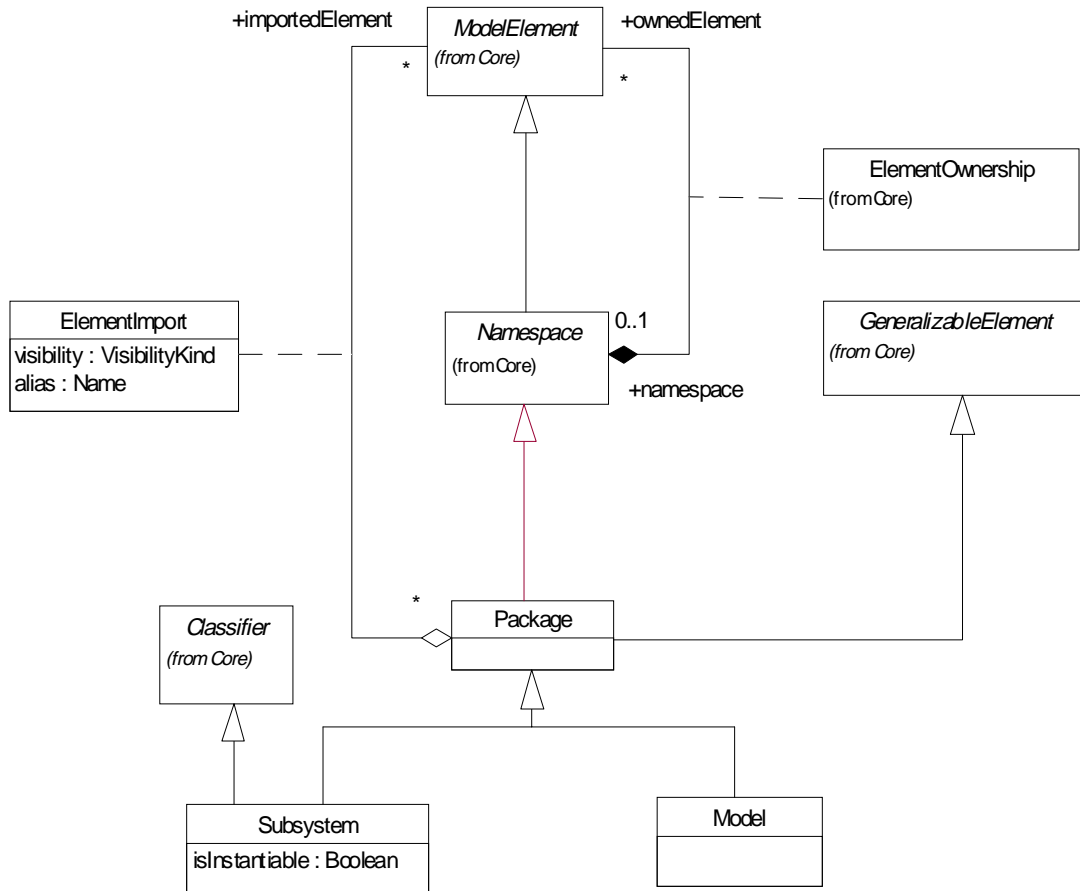

Figure 2-29 Model Management

ElementImport

An element import defines the visibility and alias of a model element included in the namespace of a package, as a result of the package importing another package.

In the metamodel an *ElementImport* reifies the relationship between a *Package* and an imported *ModelElement*. It allows redefinition of the name and the visibility for the imported *ModelElement*, i.e. the *ModelElement* may be given another name (an alias) and/or a new visibility to be used within the importing *Package*. The default is no alias, i.e. the original name will be used, and private visibility relative to the importing *Package*.

Attributes

<i>alias</i>	The alias defines a local name of the imported ModelElement, to be used within the Package.
<i>visibility</i>	An imported ModelElement is either public, protected, or private relative to the importing Package.

Model

A model is an abstraction of a physical system, with a certain purpose. This purpose determines what is to be included in the model and what is irrelevant. Thus the model completely describes those aspects of the physical system that are relevant to the purpose of the model, at the level of detail that is given by the purpose.

In the metamodel, Model is a subclass of Package. It contains a containment hierarchy of ModelElements that together describe the physical system. A Model also contains a set of ModelElements which represents the environment of the system, typically Actors, together with their interrelationships, such as Dependencies, Generalizations, and Constraints.

Different Models can be defined for the same physical system, specifying it from different viewpoints, e.g. a logical model, a design model, a use-case model. Each Model is self-contained within its viewpoint of the physical system and within its level of abstraction, i.e. within its purpose. Models may be nested, i.e. a Model may contain other Models.

Stereotypes

«systemModel»	A systemModel is a stereotyped model that contains a collection of models of the same physical system. A systemModel also contains all relationships and constraints between model elements contained in different models.
«metamodel»	A metamodel is a stereotyped model denoting that the model is an abstraction of another model, i.e., it is a model of a model. Hence, if M2 is a model of the model M1, then M2 is a metamodel of M1. It follows then that classes in M1 are instances of metaclasses in M2. The stereotype can be recursively applied, as in the case of a 4-layer metamodel architecture.

Package

A package is a grouping of model elements.

In the metamodel, Package is a subclass of Namespace and GeneralizableElement. A Package contains ModelElements like Packages, Classifiers, and Associations. A Package may also contain Constraints and Dependencies between ModelElements of the Package.

Each ModelElement of a Package has a visibility relative to the Package stating if the ModelElement is available to ModelElements in other Packages with a Permission («access» or «import») or Generalization relationship to the Package. An «access» or «import» Permission

2 UML Semantics

from one Package to another allows public ModelElements in the target Package to be referenced by ModelElements in the source Package. They differ in that all public ModelElements in imported Packages are added to the Namespace of the importing Package, whereas the Namespace of an accessing Package is not affected at all. The ModelElements available in a Package are those in the contents of the Namespace of the Package, which consists of owned and imported ModelElements, together with public ModelElements in accessed Packages.

Associations

importedElement The namespace defined by a package is extended by model elements in other, imported packages.

Stereotypes

«facade» A facade is a stereotyped package containing only references to model elements owned by another package. It is used to provide a ‘public view’ of some of the contents of a package. A facade does not contain any model elements of its own.

«framework» A framework is a stereotyped package consisting mainly of patterns, where patterns are defined as template collaborations.

«stub» A stub is a stereotyped package representing a package that is incompletely transferred; specifically, a stub provides the public parts of the package, but nothing more.

«topLevel» TopLevel is a stereotype of package denoting the top-most package in a containment hierarchy. The topLevel stereotype defines the outer limit for looking up names, as namespaces “see” outwards. A topLevel subsystem represents the top of the subsystem containment hierarchy, i.e., it is the model element that represents the boundary of the entire physical system being modeled.

Subsystem

A subsystem is a grouping of model elements that represents a behavioral unit in a physical system. A subsystem offers interfaces and has operations. In addition, the model elements of a subsystem can be partitioned into specification and realization elements, where the former, together with the operations of the subsystem, are realized by, i.e. implemented by, the latter.

In the metamodel, Subsystem is a subclass of both Package and Classifier. As such it may have a set of Features, which are constrained to be Operations and Receptions.

The contents of a Subsystem are divided into two subsets: specification elements and realization elements. The former subset provides, together with the Operations of the Subsystem, a specification of the behavior contained in the Subsystem, while the ModelElements in the latter subset jointly provide a realization of the specification. Any kind of ModelElement can be a specification element or a realization element. The relationships between the specification elements and the realization elements can be defined in different ways, e.g. with Collaborations or «realize» dependencies.

Attributes

<i>isInstantiable</i>	States whether a Subsystem is instantiable or not. If true, then the instances of the model elements within the subsystem form an implicit composition to an implicit subsystem instance, whether or not it is actually implemented.
-----------------------	--

2.14.3 Well-Formedness Rules

The following well-formedness rules apply to the Model Management package.

ElementImport

No extra well-formedness rules.

Model

No extra well-formedness rules.

Package

[1] A Package may only own or reference Packages, Classifiers, Associations, Generalizations, Dependencies, Constraints, Collaborations, StateMachines, and Stereotypes.

```
self.contents->forAll ( c |
    c.ocIsKindOf(Package) or
    c.ocIsKindOf(Classifier) or
    c.ocIsKindOf(Association) or
    c.ocIsKindOf(Generalization) or
    c.ocIsKindOf(Dependency) or
    c.ocIsKindOf(Constraint) or
    c.ocIsKindOf(Collaboration) or
    c.ocIsKindOf(StateMachine) or
    c.ocIsKindOf(Stereotype) )
```

[2] No imported element (excluding Association) may have the same name or alias as any element owned by the Package or one of its supertypes.

```
self.allImportedElements->reject( re |
    re.ocIsKindOf(Association) )->forAll( re |
    (re.elementImport.alias <> '' implies
    not (self.allContents - self.allImportedElements)->
    reject( ve |
        ve.ocIsKindOf(Association) )->exists ( ve |
            ve.name = re.elementImport.alias))
    and
```

2 UML Semantics

```
(re.elementImport.alias = '' implies
  not (self.allContents - self.allImportedElements)->
    reject ( ve |
      ve.oclIsKindOf (Association) )->exists ( ve |
        ve.name = re.name ) )
```

[3] Imported elements (excluding Association) may not have the same name or alias.

```
self.allImportedElements->reject( re |
  not re.oclIsKindOf (Association) )->forall( r1, r2 |
    (r1.elementImport.alias <> '' and
      r2.elementImport.alias <> '' and
      r1.elementImport.alias = r2.elementImport.alias
      implies r1 = r2)
  and
    (r1.elementImport.alias = '' and
      r2.elementImport.alias = '' and
      r1.name = r2.name implies r1 = r2)
  and
    (r1.elementImport.alias <> '' and
      r2.elementImport.alias = '' implies
      r1.elementImport.alias <> r2.name))
```

[4] No imported element (Association) may have the same name or alias combined with the same set of associated Classifiers as any Association owned by the Package or one of its supertypes.

```
self.allImportedElements->select( re |
  re.oclIsKindOf(Association) )->forall( re |
    (re.elementImport.alias <> '' implies
      not (self.allContents - self.allImportedElements)->
        select( ve |
          ve.oclIsKindOf(Association) )->exists(
            ve : Association |
              ve.name = re.elementImport.alias
              and
              ve.connection->size = re.connection->size and
              Sequence {1..re.connection->size}->forall( i |
                re.connection->at(i).type =
                  ve.connection->at(i).type ) ) )
      and
        (re.elementImport.alias = '' implies
          not (self.allContents - self.allImportedElements)->
            select( ve |
```

```
not ve.oclIsKindOf(Association) )->exists( ve :
Association |
    ve.name = re.name
    and
    ve.connection->size = re.connection->size and
    Sequence {1..re.connection->size}->forall( i |
        re.connection->at(i).type =
        ve.connection->at(i).type ) ) )
```

- [5] Imported elements (Association) may not have the same name or alias combined with the same set of associated Classifiers.

```
self.allImportedElements->select ( re |
    re.oclIsKindOf (Association) )->forall ( r1, r2 : Association |
        (r1.connection->size = r2.connection->size and
        Sequence {1..r1.connection->size}->forall ( i |
            r1.connection->at (i).type =
                r2.connection->at (i).type and
            r1.elementImport.alias <> '' and
            r2.elementImport.alias <> '' and
            r1.elementImport.alias = r2.elementImport.alias
            implies r1 = r2))
        and
        (r1.connection->size = r2.connection->size and
        Sequence {1..r1.connection->size}->forall ( i |
            r1.connection->at (i).type =
                r2.connection->at (i).type and
            r1.elementImport.alias = '' and
            r2.elementImport.alias = '' and
            r1.name = r2.name
            implies r1 = r2))
        and
        (r1.connection->size = r2.connection->size and
        Sequence {1..r1.connection->size}->forall ( i |
            r1.connection->at (i).type =
                r2.connection->at (i).type and
            r1.elementImport.alias <> '' and
            r2.elementImport.alias = ''
            implies r1.elementImport.alias <> r2.name)))
```

Additional Operations

- [1] The operation contents results in a Set containing the ModelElements owned by or imported by the Package.

2 UML Semantics

```
contents : Set(ModelElement)
contents = self.ownedElement->union(self.importedElement)
```

- [2] The operation `allImportedElements` results in a Set containing the Model Elements imported by the Package or one of its supertypes.

```
allImportedElements : Set(ModelElement)
allImportedElements = self.importedElement->union(
self.supertype.oClAsType(Package).allImportedElements->select( re |
re.elementImport.visibility = #public or
re.elementImport.visibility = #protected))
```

- [3] The operation `allContents` results in a Set containing the ModelElements owned by or imported by the Package or one of its ancestors.

```
allContents : Set(ModelElement);
allContents = self.contents->union(
self.parent.allContents->select(e |
e.elementOwnership.visibility = #public or
e.elementOwnership.visibility = #protected))
```

Subsystem

- [1] For each Operation in an Interface offered by a Subsystem, the Subsystem itself or at least one contained specification element must have a matching Operation.

```
self.specification.allOperations->forall(interOp |
self.allOperations->union
(self.allSpecificationElements->select(specEl |
specEl.oClIsKindOf(Classifier))->forall(c |
c.allOperations))->exists
( op | op.hasSameSignature(interOp) ) )
```

- [2] The Features of a Subsystem may only be Operations or Receptions.

```
self.feature->forall(f | f.oClIsKindOf(Operation) or
f.oClIsKindOf(Reception))
```

Additional Operations

- [1] The operation `allSpecificationElements` results in a Set containing the Model Elements specifying the behavior of the Subsystem.

```
allSpecificationElements : Set(ModelElement)
allSpecificationElements = self.allContents->select(c |
c.elementOwnership.isSpecification )
```

- [2] The operation `contents` results in a Set containing the ModelElements owned by or imported by the Subsystem.

```
contents : Set(ModelElement)
contents = self.ownedElement->union(self.importedElement)
```

2.14.4 Semantics

Package

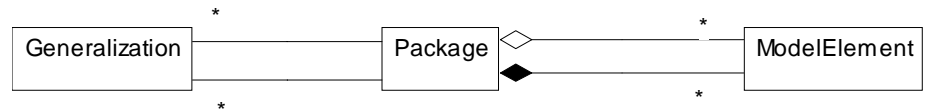

Figure 2-30 Package illustration - shows Package and its environment in the metamodel by flattening the inheritance hierarchy.

The purpose of the *package* construct is to provide a general grouping mechanism. A package cannot be instantiated, thus it has no runtime semantics. In fact, its only semantics is to define a namespace for its contents. The package construct can be used for organizing elements for any purpose; the criteria to use for grouping elements together into one package are not defined within UML.

A package owns a set of model elements, with the implication that if the package is removed from the model, so are the elements owned by the package. Elements owned by the same package must have unique names within the package, although elements in different packages may have the same name.

There may be relationships between elements contained in the same package, and between an element in one package and an element in a surrounding package at any level. In other words, elements “see” all the way out through nested levels of packages. (Note that a package with the stereotype `<<topLevel>>` defines the outer limit of this outward visibility.) Elements in peer packages, however, are encapsulated and are not a priori visible to each other. The same goes for elements in contained packages, i.e. packages do not see “inwards”. There are two ways of making elements in other packages available: by importing/accessing these other packages, and by defining generalizations to them.

An *import* dependency (a Permission dependency with the stereotype `<<import>>`) from one package to another means that the first package imports all the elements with sufficient visibility in the second package. Imported elements are not owned by the package; however, they may be used in associations, generalizations, attribute types, and other relationships owned by the package. A package defines the *visibility* of its contained elements to be private, protected, or public. Private elements are not available at all outside the containing package. Protected elements are available only to packages with generalizations to the package owning the elements, and public elements are available also to importing and accessing packages. Note that the visibility mechanism does not restrict the availability of an element to peer elements in the same package.

When an element is imported by a package it extends the namespace of that package. It is possible to give an imported element an alias to avoid name conflicts with the names of the other elements in the namespace, including other imported elements. The alias will then be the name of that element in the namespace; the element will not appear under both the alias and its original name. An imported element is by default private to the importing package. It may, however, be given a more permissive visibility relative to the importing package, i.e. the local visibility may be defined as protected or public.

2 UML Semantics

A package with an import dependency to another package imports all the public contents of the namespace defined by the supplier package, including elements of packages imported by the supplier package that are given public visibility in the supplier.

The *access* dependency (a Permission dependency with the stereotype «access») is similar to the import dependency in that it makes elements in the supplier package available to the client package. However, in this case no elements in the supplier package are included in the namespace of the client. They are simply referred to by their full pathname when referenced in the accessing package. Clearly, they are not visible to packages in turn accessing or importing this package.

A package can have *generalizations* to other packages. This means that the public and protected elements owned or imported by a package are also available to its children, and can be used in the same way as any element owned or imported by the children themselves. Elements made available to another package by the use of a generalization are referred to by the same name in the child as they are in the parent. Moreover, they have the same visibility in the child as they have in the parent package.

A package can be used to define a framework, consisting of patterns in the form of collaborations where (some of) the base elements are the parameters of the patterns. Apart from that, a framework package is described as an ordinary package.

Subsystem

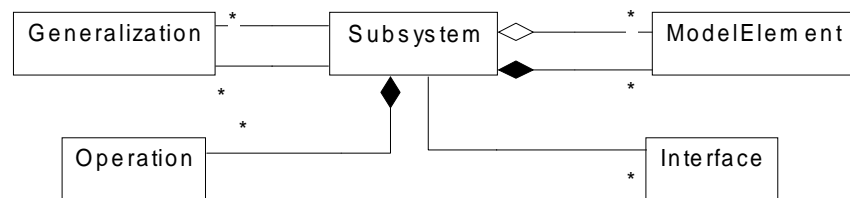

Figure 2-31 Subsystem illustration - shows Subsystem and its environment in the metamodel by flattening the inheritance hierarchy.

The purpose of the *subsystem* construct is to provide a grouping mechanism for specifying a behavioral unit of a physical system. A subsystem may or may not be instantiable. Apart from defining a namespace for its contents, a non-instantiable subsystem serves merely as a specification unit for the behavior of its contained model elements.

The contents of a *non-instantiable* subsystem have the same semantics as that of a package, thus it consists of owned elements and imported elements, with unique names or aliases within the subsystem. The contents of a subsystem may be divided into two subsets: 1) *specification elements* and 2) *realization elements*. The specification elements, together with the operations of the subsystem, are used for giving an abstract specification of the behavior offered by the realization elements.

The *specification* of a subsystem thus consists of the specification subset of the contents together with the subsystem's features (operations). It specifies the behavior performed jointly by instances of classifiers in the realization subset, without revealing anything about the contents of this subset. The specification is made in terms of model elements such as use cases and/or operations, where use cases are used to specify complete sequences performed by the subsystem (i.e., by instances of its contents) interacting with its surroundings, while operations

only specify fragments. However, the specification subset may include model elements of all kinds, e.g. classes, interfaces, constraints, relationships between model elements, state machines, etc.

A subsystem has no behavior of its own. All behavior defined in the specification of the subsystem is jointly offered by the elements in the realization subset of the contents. In general, since subsystems are classifiers, they can appear anywhere a classifier is expected. It follows that, since the subsystem itself cannot be instantiated or have any behavior of its own, the requirements posed on the subsystem in the context where it occurs is fulfilled by its contents. The same is true for associations (i.e., any association connected to a subsystem is actually connected to one of the classifiers it contains).

The correspondence between the specification and the realization of a subsystem can be specified in several ways, including collaborations and «realize» dependencies. A collaboration specifies how instances of the realization elements cooperate to jointly perform the behavior specified by a use case, an operation, etc. in the subsystem specification (i.e. how the higher level of abstraction is transformed into the lower level of abstraction). A stimulus received by an instance of a use case (higher level of abstraction) corresponds to an instance conforming to one of the classifier roles in the collaboration receiving that stimulus (lower level of abstraction). This instance communicates with other instances conforming to other classifier roles in the collaboration, and together they perform the behavior specified by the use case. All stimuli that can be received and sent by instances of the use cases are also received and sent by the conforming instances, although at a lower level of abstraction. Similarly, application of an operation of the subsystem actually means that a stimulus is sent to a contained instance which then performs a method.

Subsystems contained in the realization part represent subordinate subsystems, i.e. subsystems at the level below in the containment hierarchy, hence owned by the current subsystem.

Importing and *accessing* subsystems is done in the same way as with packages, using the *visibility* property to define whether elements are public, protected, or private to the subsystem. Both the specification part and the realization part of a subsystem may include imported elements.

A subsystem can have *generalizations* to other subsystems. This means that the public and protected elements in the contents of a subsystem are also available to its heirs. In a concrete (i.e., non-abstract) subsystem all elements in the specification, including elements from ancestors, are completely realized by cooperating realization elements, as specified with, for example, a set of collaborations. This may not be true for abstract subsystems.

Subsystems may offer a set of *interfaces*. This means that for each operation defined in an interface, the subsystem offering the interface must have a matching operation, either as a feature of the subsystem itself or of a specification element. The relationship between interface and subsystem is not necessarily one-to-one. A subsystem may realize several interfaces and one interface may be realized by more than one subsystem.

The semantics of an *instantiable* subsystem is similar to the semantics of a composite class. However, there are no explicit instances of a subsystem; instead, the instances of the model elements within the subsystem form an implicit composition to an implicit subsystem instance, whether or not it is actually implemented.

2 UML Semantics

A subsystem can be used to define a framework, consisting of patterns in the form of collaborations where some of the base elements are the parameters of the patterns. Furthermore, the specification of a framework subsystem may also be parameterized.

Model

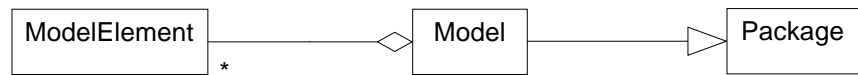

Figure 2-32 Model illustration - shows Model and its environment in the metamodel by flattening the inheritance hierarchy.

A *model* is a description of a physical system with a certain purpose, such as to give a logical or a behavioral view of the physical system to a certain category of readers. Examples of different kinds of models are ‘use case’, ‘analysis’, ‘design’, and ‘implementation’, or ‘computational’, ‘engineering’, and ‘organizational’.

Thus, a model is an abstraction of a physical system, specifying the physical system from a certain viewpoint and at a certain level of abstraction, both given by the purpose of the model. A model is complete in the sense that it covers the whole physical system, although only those aspects relevant to its purpose, i.e. within the given level of abstraction and viewpoint, are represented in the model. Furthermore, it describes the physical system only once, i.e. there is no overlapping; no part of the physical system is captured more than once in a model.

A model consists of a containment hierarchy where the top-most package or subsystem represents the boundary of the physical system. This package/subsystem may be given the stereotype «topLevel» to emphasize its role within the model.

The model may also contain model elements describing relevant parts of the system’s environment. The environment is typically modeled by actors and their interfaces. As these are external to the physical system, they reside outside the package/subsystem hierarchy. They may be collected in a separate package, or owned directly by the model. These model elements and the model elements representing the physical system may be associated with each other.

A model may be a *specialization* of another model. This implies that all elements in the ancestor are also available in the specialized model under the same name and interrelated as in the ancestor.

A model may *import* or *access* another model. The semantics is the same as for packages. However, some of the actors of the supplier model may be internal to the client. This is the case, for example, when the imported model represents a lower layer of the physical system than the client model represents. Then some of the actors of the lower layer model represent the upper layer. The conformance requirement is that there must be classifiers in the client whose instances may play the roles of such actors.

The contents of a model is the transitive closure of its owned model elements, like packages, classifiers, and relationships, together with inherited and imported elements.

There may be relationships between model elements in different models, such as refinement and trace. A *trace*, i.e. an abstraction dependency with the stereotype «trace», indicates that the connected (sets of) model elements represent the same concept. Trace is used for tracing

requirements between models, or tracing the impact on other models of a change to a model element in one model. Thus traces are usually non-directional dependencies. Relationships between model elements in different models have no impact on the model elements' meaning in their containing models because of the self-containment of models. Note, though, that even if inter-model relationships do not express any semantics in relation to the models, they may have semantics in relation to the reader or in deriving model elements as part of the overall development process.

Models may be nested, e.g. several models of the same physical system may be collected in a model with the stereotype «systemModel». The models contained in the «systemModel» all describe the physical system from different viewpoints, the viewpoints not necessarily disjoint. The «systemModel» also contains all inter-model relationships. A «systemModel» makes up a comprehensive specification of the physical system.

A physical system may be a composition of a set of subordinate physical systems, each described by its own set of models collected in a separate «systemModel».

2.14.5 Notes

In UML, there are three different ways to model a group of elements contained in another element; by using a package, a subsystem, or a class. Some pragmatics on their use include:

- Packages are used when nothing but a plain grouping of elements is required.
- Subsystems provide grouping suitable for top-down development, since the requirements on the behavior of their contents can be expressed before the realization of this behavior is defined. Furthermore, from a bottom-up perspective, the specification of a subsystem may also be seen as a provider of “high level APIs” of the subsystem.
- Classes are used when the container itself should have instances, so that it is possible to define composite objects.

As Subsystem and Model both are Packages in the metamodel, all three constructs can be combined arbitrarily to organize a containment hierarchy.

It is a tool issue to decide how many of the imported elements that must be explicitly referenced by the importing package, i.e. how many ElementImport links to actually implement. For example, if all elements have the default visibility (private) and their original names in the importing package, the information can be retrieved directly from the imported package.

If a tool does not support the separation of specification and realization elements for Subsystem, then the value of the isSpecification attribute for ElementOwnership should be false by default. See the Core for package, where ElementOwnership is defined, for details.

Because this is a logical model of the UML, distribution or sharing of models between tools is not described.

It is expected that tools will manage presentation elements, in particular diagrams, that are attached to model elements.

2 UML Semantics

Index

A

- abstract syntax section 9
- Abstraction 18
- access (Permission) 42, 178, 180
- accessing elements 41
- Action 86, 95, 101, 114
- action (ActionSequence) 87
- action (Message) 107
- ActionExpression 76
- ActionSequence 87, 95
- ActionState 159, 162, 164
- activator (Message) 107, 115
- active class 27
- active state 142
- active state configuration 143
- Activity Graphs Package 157
- activity in a state 142
- ActivityGraph 158, 162, 164
- Actor 117, 120, 122
- actualArgument (Action) 87
- addition (Include) 119
- addOnly (ChangeableKind) 21, 24, 78
- aggregate (AggregationKind) 21, 76
- aggregation (AssociationEnd) 21, 57
- AggregationKind 76
- alias (ElementImport) 171
- annotatedElement (Comment) 28
- architecture of metamodel 4
- ArgListsExpression 77
- Argument 87, 95
- argument (Binding) 26
- argument (Stimulus) 94
- AssignmentAction 95, 102
- Association 19, 44, 57
- association (AssociationEnd) 23
- association (Link) 90
- association (LinkEnd) 91
- AssociationClass 20, 44, 58
- AssociationEnd 21, 45, 57

- associationEnd (Attribute) 25
- associationEnd (LinkEnd) 91
- AssociationEndRole 104, 108
- AssociationRole 105, 108, 112
- Attribute 23, 45
- attribute (AttributeLink) 88
- AttributeLink 88, 95
- availableContents (ClassifierRole) 106
- availableFeature (ClassifierRole) 106
- availableQualifier (AssociationEndRole) 105

B

- base (AssociationEndRole) 105
- base (AssociationRole) 105
- base (ClassifierRole) 106
- base (Extend) 118
- base (Include) 119
- baseClass (Stereotype) 69
- become (Flow) 34
- Behavioral Elements Package 83
- BehavioralFeature 25, 45
- Binding 26, 38, 46, 63
- body (Constraint) 30, 68
- body (Expression) 78
- body (Mapping) 79
- body (Method) 37
- body (Name) 80
- Boolean 77
- BooleanExpression 77
- bound (SynchState) 136, 150

C

- call (Usage) 43
- CallAction 88, 95, 101, 114
- CallConcurrencyKind 77
- CallEvent 129

2 UML Semantics

CallState 160, 163
changeability (AssociationEnd) 21
changeability (Attribute) 24
changeable (ChangeableKind) 21, 24, 78
ChangeableKind 78
ChangeEvent 130
changeExpression (ChangeEvent) 130
child (Generalization) 35
choice (PseudostateKind) 81, 132
Class 26, 46, 59
Classifier 27, 47
classifier (Instance) 90
classifier (ScopeKind) 24, 33, 81
ClassifierInState 160
ClassifierRole 105, 108, 112
client (Dependency) 31
clientDependency (ModelElement) 38
Collaboration 103, 106, 109, 111, 114
collaborationMultiplicity (AssociationEndRole) 104
Collaborations Package 103
Comment 28, 50
Common Behavior Package 83
communication relationship 119, 124
communicationConnection (Message) 107
communicationLink (Stimulus) 94
complete (Generalization) 36
completion event 145
completion transition 145
Component 29, 50
ComponentInstance 88, 95
composite (AggregationKind) 21, 57, 76
CompositeState 130, 137, 143
Compound transition 145
concurrency
 in state machine 148
 synchronizing 150
concurrency (Operation) 40
concurrent (CallConcurrencyKind) 40, 77
condition (Extend) 118
conflict 149
connection (Association) 20
connection (Link) 90
constrainedElement (Constraint) 30, 68
constraining model element 114
Constraint 29, 51, 63, 67, 70, 72
constraint (ModelElement) 38, 68
constraint (Stereotype) 69
constraint language 10, 72
container (StateVertex) 135
contents (Partition) 161
context (Exception) 89
context (Interaction) 107
context (Signal) 94
context (StateMachine) 134
copy (Flow) 34
copying composite 57
create (BehavioralFeature) 26
create (CallEvent) 130
create (Usage) 44
CreateAction 89, 96, 101, 114

D

data flow relationship 165
Data Types Foundation Package 75
DataType 30, 51, 64, 75
DataValue 89, 96, 100
deepHistory (PseudostateKind) 81, 132, 144
default entry 143
defaultElement (TemplateParameter) 43
defaultValue (Parameter) 41
deferrableEvent (State) 133
deferred event 143, 144
Dependency 30, 51, 63
deploymentLocation (Component) 29
Derivation 18
derive (Abstraction) 19
derived (ModelElement) 38
descriptor 60
destroy (BehavioralFeature) 26
destroy (CallEvent) 130
destroy action 101, 114
DestroyAction 89, 96
destroyed (Instance) 90
destroyed (Link) 91
destroying composite 57
discriminator 36
discriminator (Generalization) 35, 36
disjoint (Generalization) 36
dispatchAction (Stimulus) 94
do activity 142
doActivity (State) 134
document (Component) 29
documentation (Element) 31
dynamicArguments (ActionState) 159
dynamicArguments (SubactivityState) 162
dynamicMultiplicity (ActionState) 159
dynamicMultiplicity (SubactivityState) 162

E

effect (Transition) 137
Element 31, 51
ElementImport 170, 173
ElementOwnership 31, 51
ElementResidence 32, 51
enabled transition 146
entering a concurrent composite state 144
entry (ActionState) 160
entry (State) 134
entry action 142
Event 131, 142
event processing 147
Exception 89, 96, 101
executable (Component) 29
exit (State) 134
exit action 142
exiting a concurrent state 144
exiting a non-concurrent state 144
Expression 78
expression (Guard) 132
Extend 118, 120, 125

extend (UseCase) 119
extendedElement (Stereotype) 69
extension (Extend) 118
Extension Mechanisms Foundation Package 65
ExtensionPoint 118, 120
extensionPoint (Extend) 118
extensionPoint (UseCase) 119

F

facade (Package) 172
false (Boolean) 77
Feature 32, 52
feature (Classifier) 28
file (Component) 29
FinalState 131, 138, 144
fire a transition 148
Flow 33
fork (PseudostateKind) 81, 132
fork of control 115
formalism 8
Foundation package 13
four-layer metamodel architecture 4
framework (Package) 172, 178
friend (Permission) 42
frozen (ChangeableKind) 21, 24, 78
full descriptor 60

G

GeneralizableElement 34, 52, 60
Generalization 35, 52, 60
 of package 178
 of subsystem 179
 of use case 125
generalization (GeneralizableElement) 35
Geometry 78
global (AssociationEnd) 23
global (LinkEnd) 91
Guard 131, 138, 146
guard (Transition) 137
guarded (CallConcurrencyKind) 40, 77

H

Harel statechart 155
high-level transition 144
history
 deep 144
 shallow 143

I

icon (Stereotype) 69
implementation (Generalization) 36
ImplementationClass 52
implementationClass (Class) 27
implementationLocation (ModelElement) 38
implicit (Association) 20
import (Permission) 42, 177, 180

importedElement (Package) 172
importing elements 41
in (ParameterDirectionKind) 41, 80
Include 118, 120, 125
include (UseCase) 119
incoming (StateVertex) 135
incomplete (Generalization) 36
Inheritance 60
inheritance relationship 35
initial (PseudostateKind) 81, 132
initialValue (Attribute) 24
inout (ParameterDirectionKind) 41, 80
Instance 89, 96
instance (LinkEnd) 91
instance (ScopeKind) 24, 33, 81
instantiate (Usage) 44
Instantiation 61
instantiation (CreateAction) 89
inState (ClassifierInState) 160
Integer 78
Interaction 107, 110, 113, 114
interaction (Collaboration) 106
interaction (Message) 107
Interface 36, 53, 62
 use case 124
internal transition 145
internalTransition (State) 134
invariant (Constraint) 30
isAbstract (GeneralizableElement) 34
isAbstract (Operation) 40
isAbstract (Reception) 93
isActive (Class) 27
isAsynchronous (Action) 87
isAsynchronous (CallAction) 88
isConcurrent (CompositeState) 131
isDynamic (ActionState) 159
isDynamic (SubactivityState) 162
isInstantiable (Subsystem) 173
isLeaf (GeneralizableElement) 34
isLeaf (Operation) 40
isLeaf (Reception) 93
isNavigable (AssociationEnd) 22
isQuery (BehavioralFeature) 25
isRegion (CompositeState) 131
isRoot (GeneralizableElement) 34
isRoot (Operation) 40
isRoot (Reception) 93
isSpecification (ElementOwnership) 32
isSynch (ObjectFlowState) 160
IterationExpression 79

J

join (PseudostateKind) 81, 132
join of control 115
junction (PseudostateKind) 81, 132

K

kind (Parameter) 41

2 UML Semantics

kind (PseudoState) 133

L

language (Expression) 78
layer, metamodel 4
library (Component) 29
Link 90, 98, 100
LinkEnd 91, 98
linkEnd (Instance) 90
LinkObject 91, 98
local (AssociationEnd) 23
local (LinkEnd) 91
location (ExtensionPoint) 118
LocationReference 79

M

Mapping 79
mapping (Abstraction) 19
MappingExpression 79
Message 107, 110, 114
message (Interaction) 107
MessageDirectionKind 79
metaclass (Classifier) 28
meta-metamodel layer 5
metamodel (Model) 171
metamodel layer 5
Method 37, 53
Model 171, 173, 180
model layer 5
Model Management Package 169
ModelElement 37, 53, 68, 71
modelElement (TaggedValue) 70
Multiplicity 79
multiplicity (AssociationEnd) 22
multiplicity (AssociationRole) 105
multiplicity (Attribute) 24
multiplicity (ClassifierRole) 105
MultiplicityRange 79

N

Name 79
name (Association) 20
name (AssociationEnd) 22
name (BehavioralFeature) 25
name (Feature) 33
name (ModelElement) 37
name (Parameter) 41
Namespace 39, 54
namespace (ModelElement) 38
natural language 10, 72
navigability 57
new (Instance) 90
new (Link) 91
Node 39, 55
NodeInstance 92, 98
none (AggregationKind) 21, 76
Notes section 10

O

Object 92, 98, 100
ObjectFlowState 160, 163, 165
ObjectSetExpression 80
OCL 9, 72
OCL (Language) 78
Operation 39, 55, 62
operation (CallAction) 88
operation (CallEvent) 129
ordered (OrderingKind) 22, 80
ordering (AssociationEnd) 22
OrderingKind 80
out (ParameterDirectionKind) 41, 80
outgoing (StateVertex) 135
overlapping (Generalization) 36
ownedElement (Collaboration) 106
ownedElement (Namespace) 39
owner (Feature) 33
ownerScope (Feature) 33
ownership of elements 177

P

Package 171, 173, 177
package structure of UML 6
Parameter 41, 55
parameter (AssociationEnd) 23
parameter (BehavioralFeature) 25
parameter (Event) 131
parameter (LinkEnd) 91
parameter (ObjectFlowState) 161
ParameterDirectionKind 80
parent (Generalization) 35
participant (Classifier) 28
Partition 161
partition (ActivityGraph) 159
passive class 27
Pattern 115
Permission 41
persistence (Association) 20
persistence (Attribute) 25
persistence (Classifier) 28
persistent (Instance) 90
postcondition (Constraint) 30
powertype (Classifier) 28
powertype (Generalization) 35
powertypeRange (Classifier) 28
precondition (Constraint) 30
predecessor (Message) 107, 115
presentation (ModelElement) 38
PresentationElement 62
priority of transition 149
private (VisibilityKind) 23, 32, 33, 82
ProcedureExpression 80
process (Classifier) 28
propagation semantics 57
protected (VisibilityKind) 23, 32, 33, 82
protocol state machine 151
PseudoState 132, 138, 164
PseudostateKind 81

public (VisibilityKind) 23, 32, 33, 82

Q

qualifier 58
qualifier (AssociationEnd) 23
qualifierValue (LinkEnd) 91

R

Realization 18
realize (Abstraction) 19
receiver (Message) 107
receiver (Stimulus) 94
Reception 92, 99
reception (Signal) 94
recurrence (Action) 87
referenceState (StubState) 135
referencing elements 41
refine (Abstraction) 19
Refinement 18, 63
refinement of state machine 153
Relationship 30, 42
representedClassifier (Collaboration) 106
representedOperation (Collaboration) 106
requiredTag (Stereotype) 69
resident (Component) 29
resident (ComponentInstance) 88
resident (Node) 39
resident (NodeInstance) 92
responsibility (Comment) 29
return (ParameterDirectionKind) 41, 80
return action 101
ReturnAction 93, 99
run to completion 147

S

ScopeKind 81
script (Action) 87
segment descriptor 60
self (AssociationEnd) 23
self (LinkEnd) 91
Semantics 72, 177
semantics (Classifier) 28
semantics (Operation) 40
semantics of state machines 141
Semantics Package 177
semantics section 10
semaphore 150
send (Usage) 44
SendAction 93, 99, 101, 114
sender (Message) 107
sender (Stimulus) 94
sequential (CallConcurrencyKind) 40, 77
shallowHistory (PseudostateKind) 81, 132, 143
Signal 94, 99, 101
signal (Reception) 93
signal (SendAction) 93
signal (SignalEvent) 133

SignalEvent 133
signalflow (ObjectFlowState) 161
SimpleState 133
slot (Instance) 90
sorted (OrderingKind) 22, 80
source (Transition) 137
specialization (GeneralizableElement) 35
specification (AssociationEnd) 23
specification (Method) 37
specification (Reception) 93
standard elements section 10
State 133, 142
state machine refinement 153
State Machines Package 127
statechart 155
StateMachine 134, 138, 139, 147
 semantics 141
StateVertex 135
Stereotype 69, 71, 72
stereotype (ModelElement) 68
stereotype (TaggedValue) 70
stereotypeConstraint (Stereotype) 69
Stimulus 94, 99, 101, 114
String 81
StructuralFeature 42, 56
stub (Package) 172
StubState 135, 150
SubactivityState 161, 164, 166
submachine (SubactivityState) 162
submachine (SubmachineState) 136
SubmachineState 135, 139, 144
subordinate use case 113, 124
Subsystem 172, 176, 178
subtyping and state machine 154
subvertex (CompositeState) 130
superordinate collaboration 113
superordinate use case 124
supplier (Dependency) 31
supplierDependency (ModelElement) 38
synchronization fork and join 150
SynchState 136, 139, 150
systemModel (Model) 171

T

table (Component) 29
tag (TaggedValue) 70
TaggedValue 70, 72
taggedValue (ModelElement) 68
target (Action) 87
target (Transition) 137
targetScope (AssociationEnd) 22
targetScope (Attribute) 24
taxonomic relationship 35
template 37, 38, 53, 62
 collaboration 114, 115
TemplateParameter 43
templateParameter (ModelElement) 38
terminate action 101
TerminateAction 94, 99

2 UML Semantics

thread (Classifier) 28
thread of control 115
Time 82
TimeEvent 136
TimeExpression 82
top (StateMachine) 134
topLevel (Package) 172
Trace 18, 56, 63
trace (Abstraction) 19, 180
transient (Instance) 90
transient (Link) 91
Transition 136, 139, 144, 166
 execution 146
 firing rules 149
transition (StateMachine) 135
trigger (Transition) 137
true (Boolean) 77
Type 56
type (AssociationEnd) 23
type (Attribute) 25
type (Class) 27
type (ClassifierInState) 160
type (ObjectFlowState) 161
type (Parameter) 41
TypeExpression 82

U

Uninterpreted 82
UninterpretedAction 94, 99, 102
UnlimitedInteger 82
unordered (OrderingKind) 22, 80

Usage 43, 56, 63
Use Cases Package 116
UseCase 119, 120, 123
 description 124
 instance 124
UseCaseInstance 119, 121
user object layer 5
utility (Classifier) 28

V

value (Argument) 87
value (AttributeLink) 88
value (TaggedValue) 70
ViewElement 42, 55
visibility (AssociationEnd) 23
visibility (ElementImport) 171
visibility (ElementOwnership) 32
visibility (ElementResidence) 32
visibility (Feature) 33
VisibilityKind 82

W

well-formedness rules section 9
when (TimeEvent) 136

X

xor (Association) 20

This guide describes the notation for the visual representation of the Unified Modeling Language (UML). This notation document contains brief summaries of the semantics of UML constructs, but the UML Semantics chapter must be consulted for full details.

Contents

Part 1 - Background	3-5
3.1 Introduction	3-5
Part 2 - Diagram Elements	3-7
3.2 Graphs and Their Contents	3-7
3.3 Drawing Paths	3-8
3.4 Invisible Hyperlinks and the Role of Tools	3-8
3.5 Background Information	3-8
3.6 String	3-9
3.7 Name	3-10
3.8 Label	3-11
3.9 Keywords	3-12
3.10 Expression	3-12
3.11 Note	3-14
3.12 Type-Instance Correspondence	3-15
Part 3 - Model Management	3-17
3.13 Package	3-17
3.14 Subsystem	3-19
3.15 Model	3-24
Part 4 - General Extension Mechanisms	3-27
3.16 Constraint and Comment	3-27
3.17 Element Properties	3-29
3.18 Stereotypes	3-30
Part 5 - Static Structure Diagrams	3-33
3.19 Class Diagram	3-33

3 UML Notation Guide

3.20	Object Diagram	3-34
3.21	Classifier	3-34
3.22	Class	3-34
3.23	Name Compartment	3-36
3.24	List Compartment	3-37
3.25	Attribute	3-40
3.26	Operation	3-42
3.27	Type vs. Implementation Class	3-46
3.28	Interfaces	3-48
3.29	Parameterized Class (Template)	3-49
3.30	Bound Element	3-51
3.31	Utility	3-53
3.32	Metaclass	3-53
3.33	Enumeration	3-54
3.34	Stereotype	3-54
3.35	Powertype	3-55
3.36	Class Pathnames	3-55
3.37	Accessing or Importing a Package	3-56
3.38	Object	3-58
3.39	Composite Object	3-60
3.40	Association	3-61
3.41	Binary Association	3-61
3.42	Association End	3-65
3.43	Multiplicity	3-68
3.44	Qualifier	3-70
3.45	Association Class	3-71
3.46	N-ary Association	3-73
3.47	Composition	3-74
3.48	Link	3-78
3.49	Generalization	3-79
3.50	Dependency	3-83
3.51	Derived Element	3-86
3.52	InstanceOf	3-87
Part 6 - Use Case Diagrams		3-89
3.53	Use Case Diagram	3-89
3.54	Use Case	3-91
3.55	Actor	3-92
3.56	Use Case Relationships	3-92
3.57	Actor Relationships	3-94
Part 7 - Sequence Diagrams		3-97
3.58	Kinds of Interaction Diagrams	3-97
3.59	Sequence Diagram	3-98
3.60	Object Lifeline	3-103
3.61	Activation	3-104
3.62	Message and Stimulus	3-105
3.63	Transition Times	3-107
Part 8 - Collaboration Diagrams		3-109
3.64	Collaboration	3-109
3.65	Collaboration Diagram	3-111

3.66	Pattern Structure	3-114
3.67	Collaboration Contents	3-116
3.68	Interactions	3-117
3.69	Collaboration Roles	3-118
3.70	Multiobject	3-121
3.71	Active object	3-122
3.72	Message and Stimulus	3-124
3.73	Creation/Destruction Markers	3-128
Part 9	- Statechart Diagrams	3-131
3.74	Statechart Diagram	3-131
3.75	State	3-132
3.76	Composite States	3-135
3.77	Events	3-137
3.78	Simple Transitions	3-140
3.79	Transitions to and from Concurrent States	3-141
3.80	Transitions to and from Composite States	3-142
3.81	Factored Transition Paths	3-145
3.82	Submachine States	3-147
3.83	Synch States	3-149
Part 10	- Activity Diagrams	3-151
3.84	Activity Diagram	3-151
3.85	Action state	3-153
3.86	Subactivity state	3-154
3.87	Decisions	3-154
3.88	Swimlanes	3-155
3.89	Action-Object Flow Relationships	3-157
3.90	Control Icons	3-159
3.91	Synch States	3-162
3.92	Dynamic Invocation	3-162
3.93	Conditional Forks	3-163
Part 11	- Implementation Diagrams	3-165
3.94	Component Diagram	3-165
3.95	Deployment Diagram	3-166
3.96	Node	3-168
3.97	Component	3-170
Index		3-173

3 *UML Notation Guide*

Part 1 - Background

3.1 Introduction

This chapter is arranged in parts according to semantic concepts subdivided by diagram types. Within each diagram type, model elements that are found on that diagram and their representation are listed. Note that many model elements are usable in more than one diagram. An attempt has been made to place each description where it is used the most, but be aware that the document involves implicit cross-references and that elements may be useful in places other than the section in which they are described. Be aware also that the document is nonlinear: there are forward references in it. It is not intended to be a teaching document that can be read linearly, but a reference document organized by affinity of concept.

Each part of this chapter is divided into sections, roughly corresponding to important model elements and notational constructs. Note that some of these constructs are used within other constructs; do not be misled by the flattened structure of the chapter. Within each section the following subsections may be found:

- **Semantics:** Brief summary of semantics. For a fuller explanation and discussion of fine points, see the *UML Semantics* chapter in this document.
- **Notation:** Explains the notational representation of the semantic concept (“forward mapping to notation”).
- **Presentation options:** Describes various options in presenting the model information, such as the ability to suppress or filter information, alternate ways of showing things, and suggestions for alternate ways of presenting information within a tool.

Dynamic tools need the freedom to present information in various ways and the authors do not want to restrict this excessively. In some sense, we are defining the “canonical notation” that printed documents show, rather than the “screen notation.” The ability to extend the notation can lead to unintelligible dialects, so we hope this freedom will be used in intuitive ways. The authors have not sought to eliminate all the ambiguity that some of these presentation options may introduce, because the presence of the underlying model in a dynamic tool serves to easily disambiguate things. Note that a tool is not supposed to pick just one of the presentation options and implement it. Tools should offer users the options of selecting among various presentation options, including some that are not described in this document.

- **Style guidelines:** Include suggestions for the use of stylistic markers, such as fonts, naming conventions, arrangement of symbols, etc., that are not explicitly part of the notation, but that help to make diagrams more readable. These are similar to text indentation rules in C++ or Smalltalk. Not everyone will choose to follow these suggestions, but the use of some consistent guidelines of your own choosing is recommended in any case.
- **Example:** Shows samples of the notation. String and code examples are given in the following font: This is a string sample.

3 UML Notation

- Mapping: Shows the mapping of notation elements to metamodel elements (“reverse mapping from notation”). This indicates how the notation would be represented as semantic information. Note that, in general, diagrams are interpreted in a particular context in which semantic and graphic information is gathered simultaneously. The assumption is that diagrams are constructed by an editing tool that internalizes the model as the diagram is constructed. Some semantic constructs have no graphic notation and would be shown to a user within a tool using a form or table.

Part 2 - Diagram Elements

3.2 Graphs and Their Contents

Most UML diagrams and some complex symbols are graphs containing nodes connected by paths. The information is mostly in the topology, not in the size or placement of the symbols (there are some exceptions, such as a sequence diagram with a metric time axis). There are three kinds of visual relationships that are important:

1. connection (usually of lines to 2-d shapes),
2. containment (of symbols by 2-d shapes with boundaries), and
3. visual attachment (one symbol being “near” another one on a diagram).

These visual relationships map into connections of nodes in a graph, the parsed form of the notation.

UML notation is intended to be drawn on 2-dimensional surfaces. Some shapes are 2-dimensional projections of 3-d shapes (such as cubes), but they are still rendered as icons on a 2-dimensional surface. In the near future, true 3-dimensional layout and navigation may be possible on desktop machines; however, it is not currently practical.

There are basically four kinds of graphical constructs that are used in UML notation:

1. Icons - An icon is a graphical figure of a fixed size and shape. It does not expand to hold contents. Icons may appear within area symbols, as terminators on paths or as standalone symbols that may or may not be connected to paths.
2. 2-d Symbols - Two-dimensional symbols have variable height and width and they can expand to hold other things, such as lists of strings or other symbols. Many of them are divided into compartments of similar or different kinds. Paths are connected to two-dimensional symbols by terminating the path on the boundary of the symbol. Dragging or deleting a 2-d symbol affects its contents and any paths connected to it.
3. Paths - Sequences of line segments whose endpoints are attached. Conceptually a path is a single topological entity, although its segments may be manipulated graphically. A segment may not exist apart from its path. Paths are always attached to other graphic symbols at both ends (no dangling lines). Paths may have *terminators*, that is, icons that appear in some sequence on the end of the path and that qualify the meaning of the path symbol.
4. Strings - Present various kinds of information in an “unparsed” form. UML assumes that each usage of a string in the notation has a syntax by which it can be parsed into underlying model information. For example, syntaxes are given for attributes, operations, and transitions. These syntaxes are subject to extension by tools as a presentation option. Strings may exist as singular elements of symbols or compartments of symbols, as elements in lists (in which case the position in the list conveys information), as labels attached to symbols or paths, or as stand-alone elements on a diagram.

3 UML Notation

3.3 Drawing Paths

A path consists of a series of line segments whose endpoints coincide. The entire path is a single topological unit. Line segments may be orthogonal lines, oblique lines, or curved lines. Certain common styles of drawing lines exist: all orthogonal lines, or all straight lines, or curves only for bevels. The line style can be regarded as a tool restriction on default line input. When line segments cross, it may be difficult to know which visual piece goes with which other piece; therefore, a crossing may optionally be shown with a small semicircular jog by one of the segments to indicate that the paths do not intersect or connect (as in an electrical circuit diagram).

In some relationships (such as aggregation and generalization) several paths of the same kind may connect to a single symbol. In some circumstances (described for the particular relationship) the line segments connected to the symbol can be combined into a single line segment, so that the path from that symbol branches into several paths in a kind of tree. This is purely a graphical presentation option; conceptually the individual paths are distinct. This presentation option may not be used when the modeling information on the segments to be combined is not identical.

3.4 Invisible Hyperlinks and the Role of Tools

A notation on a piece of paper contains no hidden information. A notation on a computer screen may contain additional invisible hyperlinks that are not apparent in a static view, but that can be invoked dynamically to access some other piece of information, either in a graphical view or in a textual table. Such dynamic links are as much a part of a *dynamic* notation as the visible information, but this guide does not prescribe their form. We regard them as a tool responsibility. This document attempts to define a *static* notation for the UML, with the understanding that some useful and interesting information may show up poorly or not at all in such a view. On the other hand, we do not know enough to specify the behavior of all dynamic tools, nor do we want to stifle innovation in new forms of dynamic presentation. Eventually some of the dynamic notations may become well enough established to standardize them, but we do not feel that we should do so now.

3.5 Background Information

3.5.1 Presentation Options

Each appearance of a symbol for a class on a diagram or on different diagrams may have its own presentation choices. For example, one symbol for a class may show the attributes and operations and another symbol for the same class may suppress them. Tools may provide style sheets attached either to individual symbols or to entire diagrams. The style sheets would specify the presentation choices. (Style sheets would be applicable to most kinds of symbols, not just classes.)

Not all modeling information is presented most usefully in a graphical notation. Some information is best presented in a textual or tabular format. For example, much detailed programming information is best presented as text lists. The UML does not assume that all of the information in a model will be expressed as diagrams; some of it may only be available as

tables. This document does not attempt to prescribe the format of such tables or of the forms that are used to access them, because the underlying information is adequately described in the UML metamodel and the responsibility for presenting tabular information is a tool responsibility. It is assumed that hidden links may exist from graphical items to tabular items.

3.6 String

A string is a sequence of characters in some suitable character set used to display information about the model. Character sets may include non-Roman alphabets and characters.

3.6.1 Semantics

Diagram strings normally map underlying model strings that store or encode information about the model, although some strings may exist purely on the diagrams. UML assumes that the underlying character set is sufficient for representing multibyte characters in various human languages; in particular, the traditional 8-bit ASCII character set is insufficient. It is assumed that the tool and the computer manipulate and store strings correctly, including escape conventions for special characters, and this document will assume that arbitrary strings can be used without further fuss.

3.6.2 Notation

A string is displayed as a text string graphic. Normal printable characters should be displayed directly. The display of nonprintable characters is unspecified and platform-dependent. Depending on purpose, a string might be shown as a single-line entity or as a paragraph with automatic line breaks.

Typeface and font size are graphic markers that are normally independent of the string itself. They may code for various model properties, some of which are suggested in this document and some of which are left open for the tool or the user.

3.6.3 Presentation Options

Tools may present long strings in various ways, such as truncation to a fixed size, automatic wrapping, or insertion of scroll bars. It is assumed that there is a way to obtain the full string dynamically.

3.6.4 Example

BankAccount

integrate (f: Function, from: Real, to: Real)

{ author = "Joe Smith", deadline = 31-March-1997, status = analysis }

3 UML Notation

The purpose of the shuffle operation is nominally to put the cards into a random configuration. However, to more closely capture the behavior of physical decks, in which blocks of cards may stick together during several riffles, the operation is actually simulated by cutting the deck and merging the cards with an imperfect merge.

3.6.5 Mapping

A graphic string maps into a string within a model element. The mapping depends on context. In some circumstances, the visual string is parsed into multiple model elements. For example, an operation signature is parsed into its various fields. Further details are given with each kind of symbol.

3.7 Name

3.7.1 Semantics

A name is a string that is used to identify a model element uniquely within some scope. A pathname is used to find a model element starting from the root of the system (or from some other point). A name is a selector (qualifier) within some scope—the scope is made clear in this document for each element that can be named.

A pathname is a series of names linked together by a delimiter (such as ‘::’). There are various kinds of pathnames described in this document, each in its proper place and with its particular delimiter.

3.7.2 Notation

A name is displayed as a text string graphic. Normally a name is displayed on a single line and will not contain nonprintable characters. Tools and languages may impose reasonable limits on the length of strings and the character set they use for names, possibly more restrictive than those for arbitrary strings, such as comments.

3.7.3 Example

Names:

BankAccount

integrate

controller

abstract

this_is_a_very_long_name_with_underscores

Pathname:

MathPak::Matrices::BandedMatrix

3.7.4 Mapping

Maps to the name of a model element. The mapping depends on context, as with String. Further details are given with the particular element.

3.8 Label

A label is a string that is attached to a graphic symbol.

3.8.1 Semantics

A label is a term for a particular use of a string on a diagram. It is purely a notational term.

3.8.2 Notation

A label is a string that is attached graphically to another symbol on a diagram. Visually the attachment normally is by containment of the string (in a closed region) or by placing the string near the symbol. Sometimes the string is placed in a definite position (such as below a symbol) but most of the time the statement is that the string must be “near” the symbol. A tool maintains an explicit internal graphic linking between a label and a graphic symbol, so that the label drags with the symbol, but the final appearance of the diagram is a matter of aesthetic judgment and should be made so that there is no confusion about which symbol a label is attached to. Although the attachment may not be obvious from a visual inspection of a diagram, the attachment is clear and unambiguous at the graphic level (and poses no ambiguity in the semantic mapping).

3.8.3 Presentation Options

A tool may visually show the attachment of a label to another symbol using various aids (such as a line in a given color, flashing of matched elements, etc.) as a convenience.

3.8.4 Example

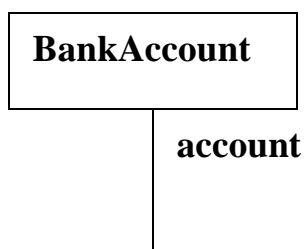

Figure 3-1 Attachment by Containment and Attachment by Adjacency

3 UML Notation

3.9 Keywords

The number of easily-distinguishable visual symbols is limited. The UML notation makes use of text keywords in places to distinguish variations on a common theme, including metamodel subclasses of a base class, stereotypes of a metamodel base class, and groups of list elements. From the user's perspective, the metamodel distinction between metamodel subclasses and stereotypes is often unimportant, although it is important to tool builders and others who implement the metamodel.

The general notation for the use of a keyword is to enclose it in guillemets («»):

«keyword»

Certain predefined keywords are described in the text of this document. These must be treated as reserved words in the notation. Others are available for users to employ as stereotype names. The use of a stereotype name that matches a predefined keyword is ill-formed.

3.10 Expression

3.10.1 Semantics

Various UML constructs require *expressions*, which are linguistic formulas that yield values when evaluated at run-time. These include expressions for types, boolean values, and numbers. UML does not include an explicit linguistic analyzer for expressions. Rather, expressions are expressed as strings in a particular *language*. The OCL constraint language is used within the UML semantic definition and may also be used at the user level; other languages (such as programming languages) may also be used.

UML avoids specifying the syntax for constructing type expressions because they are so language-dependent. It is assumed that the name of a class or simple data type will map into a simple *Classifier* reference, but the syntax of complicated language-dependent type expressions, such as C++ function pointers, is the responsibility of the specification language.

3.10.2 Notation

An expression is displayed as a string defined in a particular language. The syntax of the string is the responsibility of a tool and a linguistic analyzer for the language. The assumption is that the analyzer can evaluate strings at run-time to yield values of the appropriate type, or can yield semantic structures to capture the meaning of the expression. For example, a type expression evaluates to a *Classifier* reference, and a boolean expression evaluates to a true or false value. The language itself is known to a modeling tool but is generally implicit on the diagram, under the assumption that the form of the expression makes its purpose clear.

3.10.3 Example

BankAccount

BankAccount * (*) (Person*, int)

array [1..20] of reference to range (-1.0..1.0) of Real
 [i > j and self.size > i]

3.10.4 Mapping

An expression string maps to an Expression element (possibly a particular subclass of Expression, such as ObjectSetExpression or TimeExpression).

3.10.5 OCL Expressions

UML includes a definition of the OCL language, which is used to define constraints within the UML metamodel itself. The OCL language may be supported by tools for user-written expressions as well. Other possible languages include various computer languages as well as plain text (which cannot be parsed by a tool, of course, and is therefore only for human information). The OCL language is defined in Chapter 7, Object Constraint Language Specification.

3.10.6 Selected OCL Notation

Syntax for some common navigational expressions are shown below. These forms can be chained together. The leftmost element must be an expression for an object or a set of objects. The expressions are meant to work on sets of values when applicable.

<i>item</i> '.' <i>selector</i>	the <i>selector</i> is the name of an attribute in the item or the name of the target end of a link attached to the item. The result is the value of the attribute or the related object(s). The result is a value or a set of values depending on the multiplicities of the item and the association.
<i>item</i> '.' <i>selector</i> '[' <i>qualifier-value</i> ']	the <i>selector</i> designates a qualified association that qualifies the <i>item</i> . The <i>qualifier-value</i> is a value for the qualifier attribute. The result is the related object selected by the qualifier. Note that this syntax is applicable to array indexing as a form of qualification.
<i>set</i> '->' 'select' '(' <i>boolean-expression</i> ')'	the <i>boolean-expression</i> is written in terms of objects within the set. The result is the subset of objects in the set for which the boolean expression is true.

3.10.7 Example

flight.pilot.training_hours > flight.plane.minimum_hours
 company.employees->select (title = "Manager" and self.reports->size > 10)

3 UML Notation

3.11 Note

A note is a graphical symbol containing textual information (possibly including embedded images). It is a notation for rendering various kinds of textual information from the metamodel, such as constraints, comments, method bodies, and tagged values.

3.11.1 Semantics

A note is a notational item. It shows textual information within some semantic element.

3.11.2 Notation

A note is shown as a rectangle with a “bent corner” in the upper right corner. It contains arbitrary text. It appears on a particular diagram and may be attached to zero or more modeling elements by dashed lines.

3.11.3 Presentation Options

A note may have a stereotype.

A note with the keyword “constraint” or a more specific stereotype of constraint (such as the code body for a method) designates a constraint that is part of the model and not just part of a diagram view. Such a note is the view of a model element (the constraint).

3.11.4 Example

See also Figure 3-15 on page 28 for a note symbol containing a constraint.

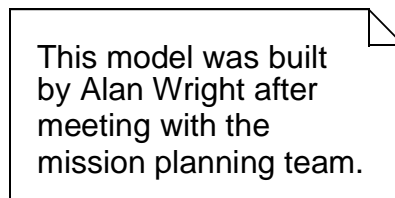

Figure 3-2 Note

3.11.5 Mapping

A note may represent the textual information in several possible metamodel constructs; it must be created in context that is known to a tool, and the tool must maintain the mapping. The string in the note maps to the body of the corresponding modeling element. A note may represent:

- a constraint,
- a tagged value,
- the body of a method, or

3.12 Type-Instance Correspondence

- other string values within modeling elements.

It may also represent a comment attached directly to a diagram element.

3.12 Type-Instance Correspondence

A major purpose of modeling is to prepare generic descriptions that describe many specific items. This is often known as the *type-instance dichotomy*. Many or most of the modeling concepts in UML have this dual character, usually modeled by two paired modeling elements, one represents the generic descriptor and the other the individual items that it describes. Examples of such pairs in UML include: Class-Object, Association-Link, Parameter-Value, Operation-Call, and so on.

Although diagrams for type-like elements and instance-like elements are not exactly the same, they share many similarities. Therefore, it is convenient to choose notation for each type-instance pair of elements such that the correspondence is visually apparent immediately. There are a limited number of ways to do this, each with advantages and disadvantages. In UML, the type-instance distinction is shown by employing the same geometrical symbol for each pair of elements and by underlining the name string (including type name, if present) of an instance element. This visual distinction is generally easily apparent without being overpowering even when an entire diagram contains instance elements.

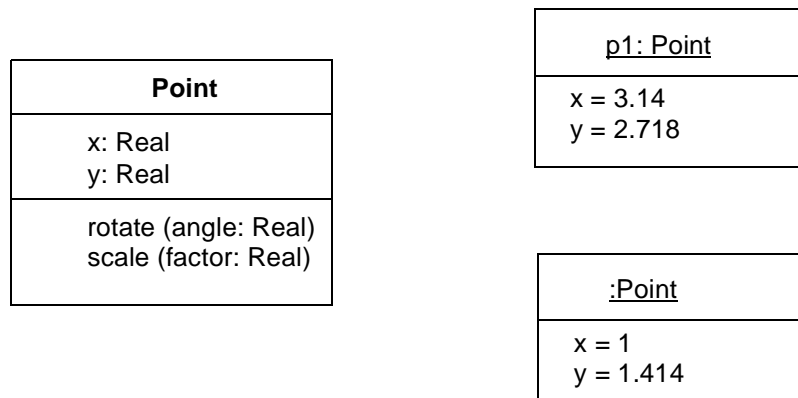

Figure 3-3 Classes and Objects

A tool is free to substitute a different graphic marker for instance elements at the user's option, such as color, fill patterns, or so on.

Roles (in collaborations) are somewhat between types and instances. Like instances, they identify distinct occurrences of a single classifier. Like types, they describe a reusable element that can have many distinct instances. A role is a distinguishable use of a classifier, but one that is still part of a general description (a collaboration) that can be used to create many instances. A run-time object may correspond to zero or more classes and to zero or more roles. The notation for a role permits indication of its base classifiers. The notation for an instance permits specification of its classifiers, its roles, or both.

3 UML Notation

A role is indicated by a name, colon, and type, not underlined and part of a collaboration. An instance is indicated by an optional name, optional slash followed by list of roles, colon, and list of types.

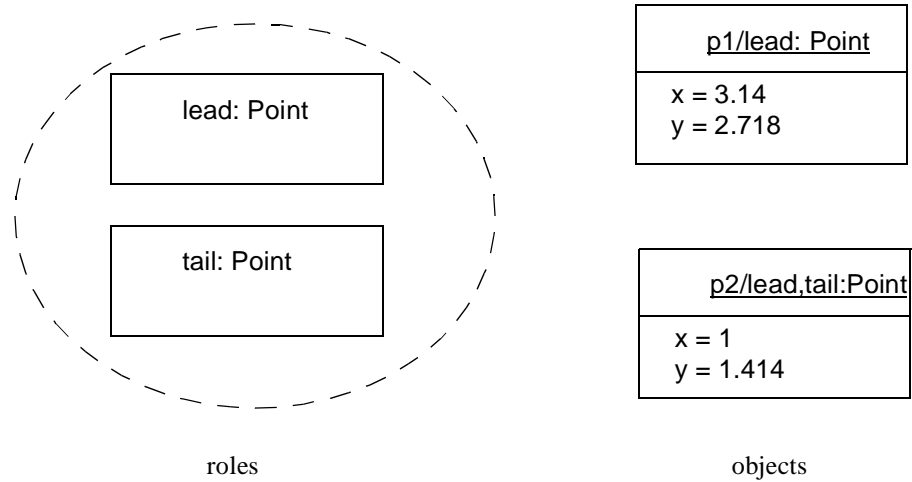

Figure 3-4 Roles and objects

Part 3 - Model Management

3.13 Package

3.13.1 Semantics

A *package* is a grouping of model elements. Packages themselves may be nested within other packages. A package may contain subordinate packages as well as other kinds of model elements. All kinds of UML model elements can be organized into packages.

Note that packages *own* model elements and are the basis for configuration control, storage, and access control. Each element can be directly owned by a single package, so the package hierarchy is a strict tree. However, packages can reference other packages, modeled by using one of the stereotypes «import» and «access» of Permission dependency, so the usage network is a graph. Other kinds of dependencies between packages usually imply that one or more dependencies among the elements exists.

3.13.2 Notation

A package is shown as a large rectangle with a small rectangle (a “tab”) attached to the left side of the top of the large rectangle. It is the common folder icon.

The contents of the package may be shown within the large rectangle. Contents may also be shown by branching lines to contained elements, drawn outside of the package (see example below). A plus sign (+) within a circle is drawn at the end attached to the container.

- If the contents of the package are not shown within the large rectangle, then the name of the package may be placed within the large rectangle.
- If the contents of the package are shown within the large rectangle, then the name of the package may be placed within the tab.

A keyword string may be placed above the package name. The predefined stereotypes *facade*, *framework*, *stub*, and *topLevel* are notated within guillemets.

A list of properties may be placed in braces after or below the package name. Example: {abstract}. See Section 3.17, “Element Properties,” on page 3-29 for details of property syntax.

The visibility of a package element outside the package may be indicated by preceding the name of the element by a visibility symbol (‘+’ for public, ‘-’ for private, ‘#’ for protected).

Relationships may be drawn between package symbols to show relationships between some of the elements in the packages. An import or access relationship between two packages is drawn as a dashed arrow with open arrowhead, labeled with the string «import» or «access», respectively.

Elements from imported or accessed packages may be shown outside the package symbol. As (public) elements in imported packages are added to the client namespace, they may alternatively be drawn inside the package symbol.

3 UML Notation

3.13.3 Presentation Options

A tool may show visibility by a graphic marker, such as color or font.

A tool may also show visibility by selectively displaying those elements that meet a given visibility level, e.g. all of the public elements only.

A diagram showing a package with contents must not necessarily show all its contents; it may show a subset of the contained elements according to some criterion.

3.13.4 Style Guidelines

It is expected that packages with large contents will be shown as simple icons with names, in which the contents may be dynamically accessed by “zooming” to a detailed view.

3.13.5 Example

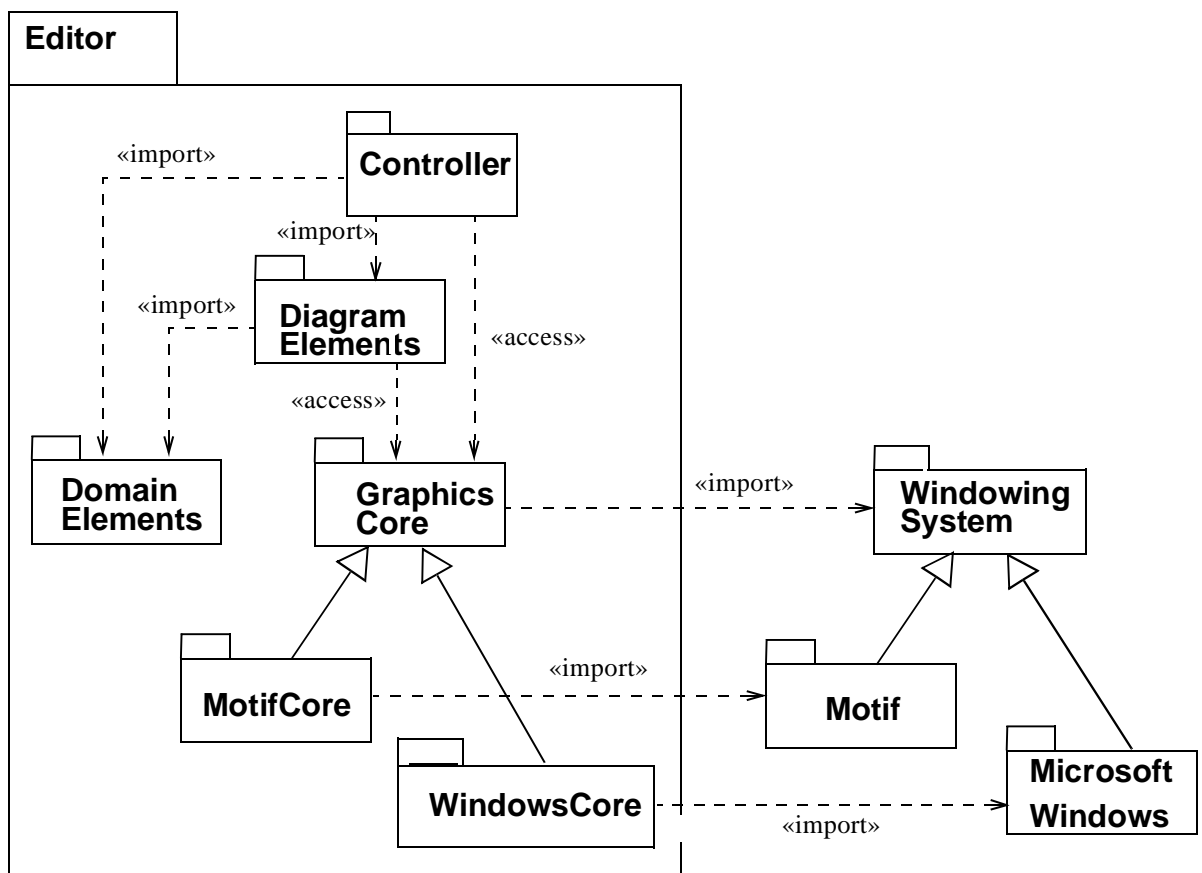

Figure 3-5 Packages and their access and import relationships.

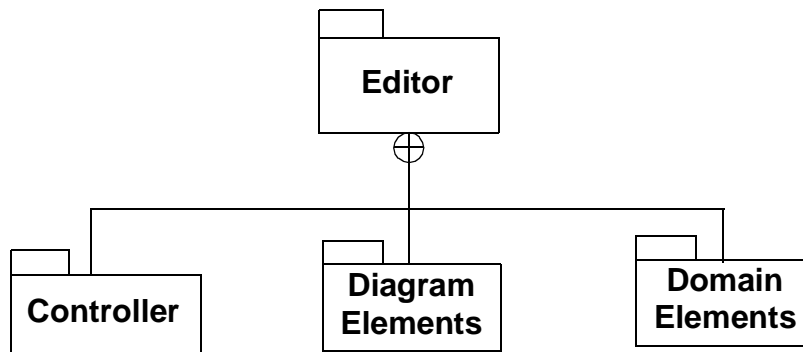

Figure 3-6 Some of the contents of the Editor package shown in a tree structure.

3.13.6 Mapping

A package symbol maps into a Package element. The name on the package symbol is the name of the Package element. If there is a string above the package name other than «model» or «subsystem», then it maps into a Package element with the corresponding stereotype. If there is a string «model» or «subsystem», then it maps into a Model or Subsystem element, respectively.

A relationship icon drawn from the package symbol boundary to another package symbol maps into a corresponding relationship to the other package element.

A symbol directly contained within the package symbol (i.e., not contained within another symbol) maps into a model element either owned or referenced by the package element. The alias used for a referenced element is often its pathname, in which case it is directly visible from the diagram that the element is not owned by the package. Only the reference is owned by the current package. Alternatively, a symbol shown outside the package symbol, attached to one of the symbols within the package symbol, denotes a referenced model element.

Symbols connected to the package symbol by branching lines with a plus sign at the end attached to the package symbol, map to elements in the package.

3.14 Subsystem

3.14.1 Semantics

Whereas a package is a generic mechanism for organizing model elements, a *subsystem* represents a behavioral unit in the physical system, and hence in the model. A subsystem offers interfaces and has operations, and its contents may be partitioned into specification and realization elements. The specification of the subsystem consists of operations on the subsystem, together with specification elements such as use cases, state machines, etc.

3 UML Notation

Subsystems may or may not be instantiable. A non-instantiable subsystem serves merely as a specification unit for the behavior of its contained model elements.

3.14.2 Notation

A subsystem is notated basically in the same way as a package, with the addition of a fork symbol placed in the upper right corner of the large rectangle. The name of the subsystem (together with optional keyword, stereotype, etc) is placed within the large rectangle. Optionally, especially if contents of the subsystem is shown within the large rectangle, the subsystem name and the fork are placed within the tab (the small rectangle).

An instantiable subsystem has the string «instantiable» above its name.

The large rectangle has three compartments, one for operations and one for each of the subsets specification elements and realization elements. These are usually shown by dividing the rectangle by a vertical line, and then dividing the area to the left of this line into two compartments by a horizontal line. The operations are shown in the upper left compartment, the specification elements in the compartment below, and the realization elements in the right compartment. The latter two compartments are labeled 'Specification Elements' and 'Realization Elements', respectively, to avoid potential ambiguity. The operations compartment is unlabeled. This is the general pattern for subsystem notation, although there are many different ways to customize it in a particular diagram, see Presentation Options and Example below.

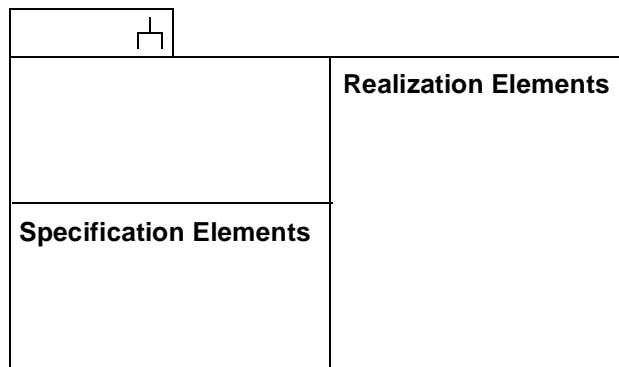

Figure 3-7 The general pattern for subsystem notation, with three compartments.

The mapping from the realization part to the specification part, i.e. to operations and specification elements, is drawn using dashed arrows with closed, hollow arrowheads. For collaborations, the mapping may also be expressed textually.

When a subsystem is shown together with other, peer elements in a diagram, it is often shown without contents, in which case there are no compartments in the large rectangle. See Example below.

3.14.3 Presentation Options

The fork symbol may be replaced by the keyword «*subsystem*» placed above the name of the subsystem.

One or more of the compartments may be collapsed or suppressed. In cases where more than one diagram is used to show all information about a particular subsystem, each diagram shows a subset of the subsystem's features and/or contents. Hence, compartments not relevant in a particular diagram are suppressed.

All contained elements in a subsystem may be shown together in one, non-labeled compartment, i.e. no visual differentiating between specification elements and realization elements is done.

Tools may provide alternative ways to differentiate specification elements from realization elements, such as different colors, using the keyword «*specification*» for specification elements, etc.

As with packages, the contents of a subsystem may be shown using tree notation. Distinction between specification and realization elements may then be done e.g. by having two separate, labeled branches, or by showing the category separately for each element in the tree as suggested above.

3.14.4 Example

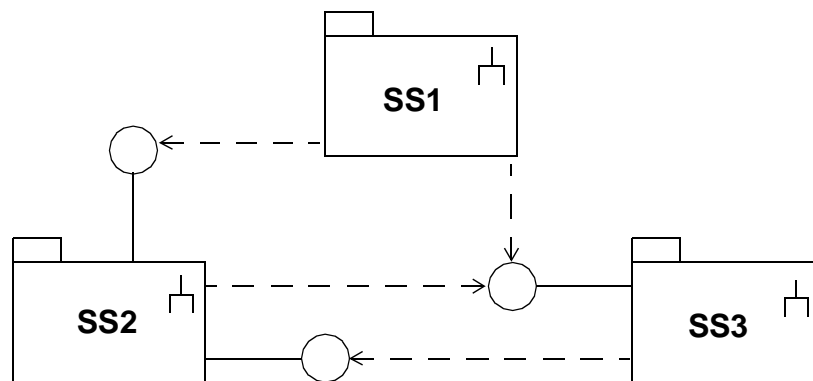

Figure 3-8 An overview diagram showing subsystems with interfaces and their dependencies.

3 UML Notation

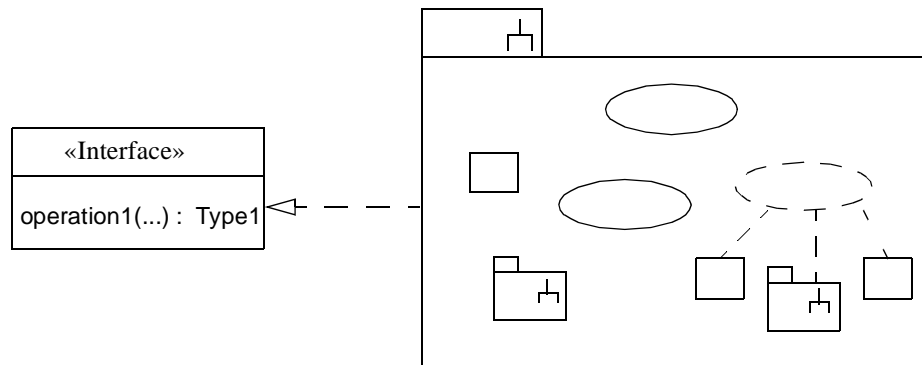

Figure 3-9 All contained elements of a subsystem shown together without division into compartments. Here, the subsystem offers operation1(...) although this is not explicitly shown.

In Figure 3-9 no visual separation between specification and realization elements is made. The following three figures are schematic examples where the specification/realization distinction is explicit. Together these figures constitute an example of how the basic notation for subsystem can be used to show different “views” of a subsystem in different diagrams, together giving the whole picture of the subsystem.

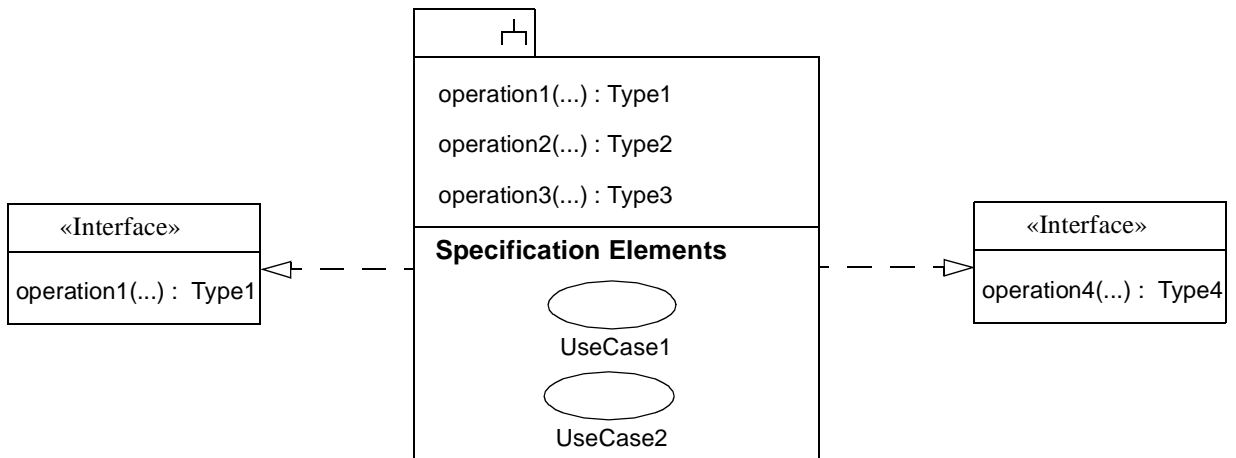

Figure 3-10 The specification part of a subsystem; compartment for realization part is suppressed. Implicit from the diagram is that the operation4(...) is either an operation of a specification element (UseCase1 or UseCase2) or of the subsystem itself. Furthermore, in cases where no operations are used for the specification but only contained specification elements, there is no operations compartment, and *vice versa*.

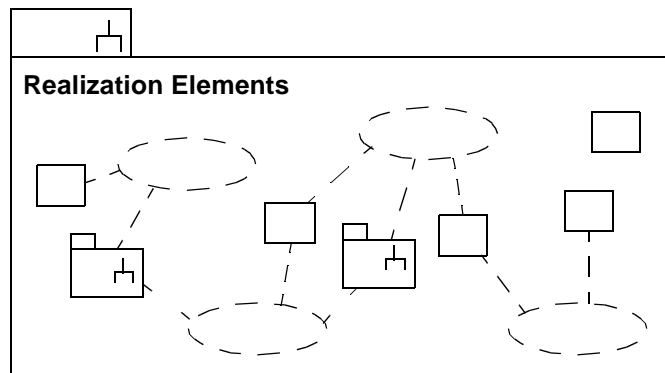

Figure 3-11 The realization part of a subsystem; compartments for specification part (i.e. operations and specification elements) are suppressed. Alternatively, collaborations could be shown in a separate diagram.

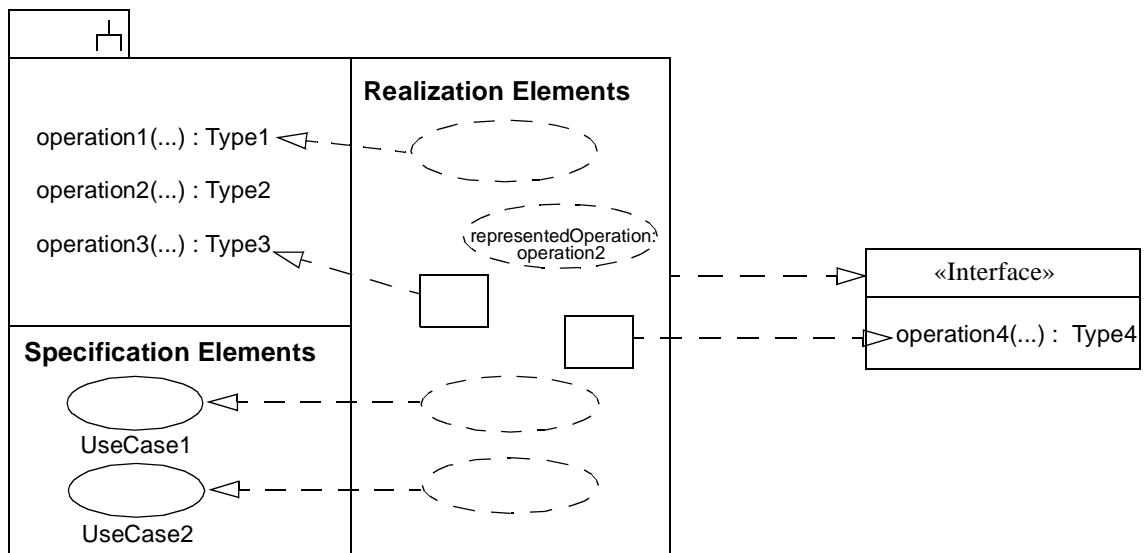

Figure 3-12 The mapping between specification part and realization part shown using all three compartments, but only those realization elements with relevance to the mapping are shown. The figure also shows examples of different ways to express the mapping.

3.14.5 Mapping

A subsystem symbol maps into a Subsystem with the given name. The mapping is analogous to that of package symbols, with the following addition:

A symbol within a compartment of the large rectangle labeled ‘Specification Elements’ or ‘Realization Elements’ is mapped to a specification or realization element of the subsystem, respectively. An operation signature string within a non-labeled compartment maps to an operation of the subsystem. Note that a labeled compartment may coincide with the whole rectangle.

3 UML Notation

A symbol, that is not an operation signature string, within a non-labeled compartment maps to an element contained in the subsystem.

A dashed arrow with closed, hollow arrowhead from a symbol denoting a realization element to a symbol denoting a specification element or an operation maps to a «realize» relationship between the corresponding elements.

3.15 Model

3.15.1 Semantics

A model is an abstraction of a physical system, with a certain purpose. It describes the physical system from a specific viewpoint and at a certain level of abstraction. A model contains all the model elements needed to represent a physical system completely by the criteria of this particular model. The model elements in a model are organized into a package/subsystem hierarchy, where the top-most package/subsystem represents the boundary of the physical system.

Different models of the same physical system show different aspects of the system, from different viewpoints and/or levels of abstraction. The pre-defined stereotype «systemModel» can be applied to a model containing the entire set of models for the complete physical system.

Relationships between elements in different models have no semantic impact on the contents of the models because of the self-containment of models. However, they are useful for tracing refinements and for keeping track of requirements between models.

Relationships between models express refinement, import, etc.

3.15.2 Notation

A model is notated using the ordinary package symbol with a small triangle in the upper right corner of the large rectangle. Optionally, especially if contents of the model is shown within the large rectangle, the triangle may be drawn to the right of the model name in the tab.

Relationships between models as well as relationships between elements in different models are shown using the notation for the given kind of relationship. In particular, trace dependencies are notated with a dashed line, with an optional open arrowhead, and the keyword «trace».

3.15.3 Presentation Options

A model may be notated as a package, using the ordinary package symbol with the keyword «model» placed above the name of the model.

3.15.4 Example

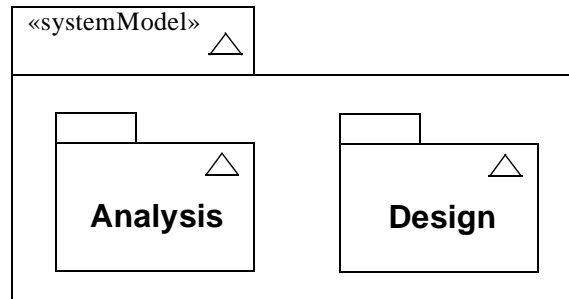

Figure 3-13 A «systemModel» containing an analysis model and a design model.

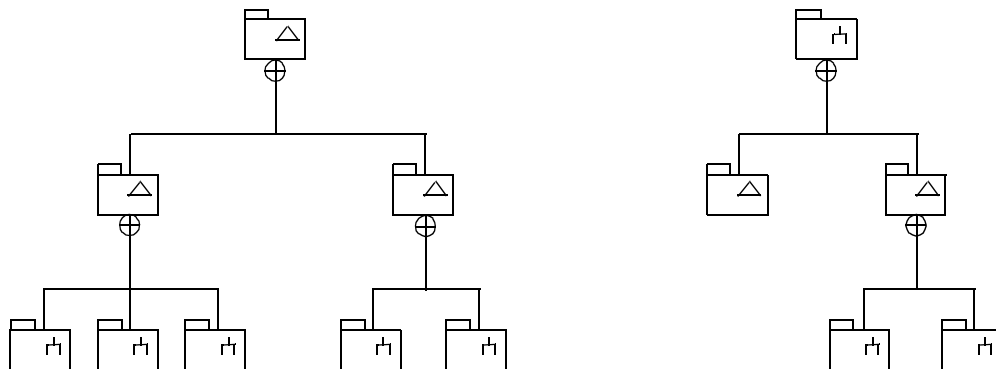

Figure 3-14 Two examples of containment hierarchies with models and subsystems shown using branching lines. The left hierarchy is based on Model, whereas the right one is based on Subsystem.

3.15.5 Mapping

A model symbol maps to a Model with the given name. The mapping is analogous to that of package symbols.

3 *UML Notation*

Part 4 - General Extension Mechanisms

The elements in this section are general purpose mechanisms that may be applied to any modeling element. The semantics of a particular use depends on a convention of the user or an interpretation by a particular constraint language or programming language; therefore, they constitute an extensibility device for UML.

3.16 Constraint and Comment

3.16.1 Semantics

A *constraint* is a semantic relationship among model elements that specifies conditions and propositions that must be maintained as true; otherwise, the system described by the model is invalid (with consequences that are outside the scope of UML). Certain kinds of constraints (such as an association “xor” constraint) are predefined in UML, others may be user-defined. A user-defined constraint is described in words in a given language, whose syntax and interpretation is a tool responsibility. A constraint represents semantic information attached to a model element, not just to a view of it.

A *comment* is a text string (including references to human-readable documents) attached directly to a model element. A comment can attach arbitrary textual information to any model element of presumed general importance but it has no semantic force. Comments may be used for explaining the reasons for decisions, among other things.

3.16.2 Notation

A constraint is shown as a text string in braces ({ }). There is an expectation that individual tools may provide one or more languages in which formal constraints may be written. One predefined language for writing constraints is OCL (see Chapter 7, Object Constraint Language Specification); otherwise, the constraint may be written in natural language. Each constraint is written in a specific language, although the language is not generally displayed on the diagram (the tool must keep track of it, however).

For an element whose notation is a text string (such as an attribute, etc.), the constraint string may follow the element text string in braces.

For a list of elements whose notation is a list of text strings (such as the attributes within a class), a constraint string may appear as an element in the list. The constraint applies to all succeeding elements of the list until another constraint string list element or the end of the list. A constraint attached to an individual list element does not supersede the general constraint, but may augment or modify individual constraints within the constraint string.

For a single graphical symbol (such as a class or an association path), the constraint string may be placed near the symbol, preferably near the name of the symbol, if any.

3 UML Notation

For two graphical symbols (such as two classes or two associations), the constraint is shown as a dashed arrow from one element to the other element labeled by the constraint string (in braces). The direction of the arrow is relevant information within the constraint. The client (tail of the arrow) is mapped to the first position and the supplier (head of the arrow) is mapped to the second position in the constraint.

For three or more graphical symbols, the constraint string is placed in a note symbol and attached to each of the symbols by a dashed line. This notation may also be used for the other cases. For three or more paths of the same kind (such as generalization paths or association paths), the constraint may be attached to a dashed line crossing all of the paths.

A comment is shown as a text string (not enclosed in braces) within a note icon. Syntax for including comments within other elements (such as expressions or constraints) are not specified by UML but may be provided by a tool as part of the expression syntax for a particular language.

3.16.3 Example

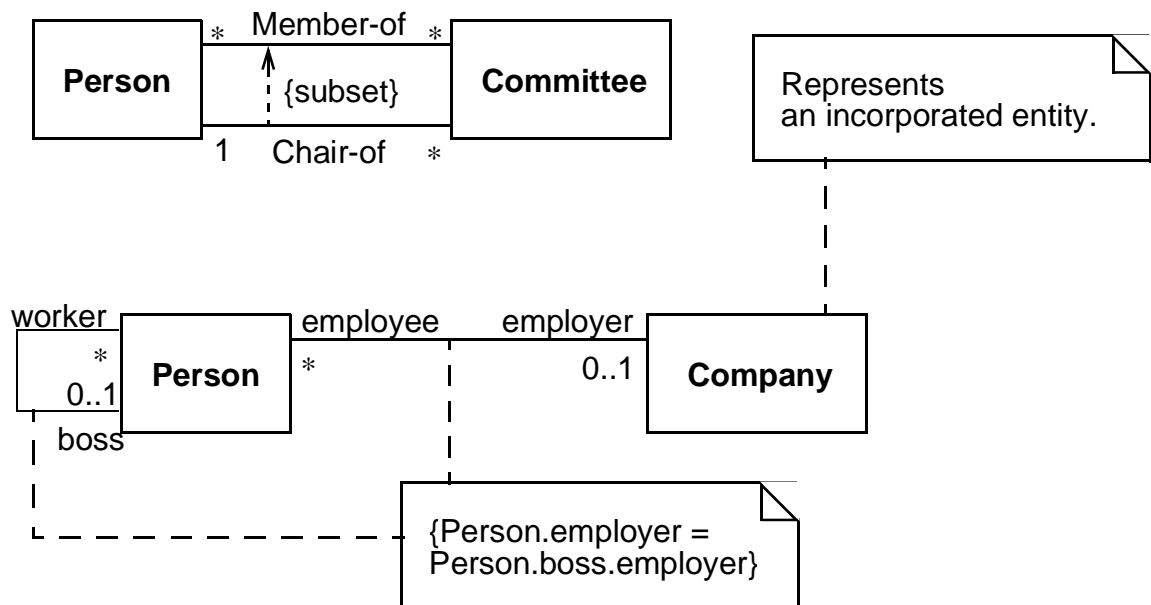

Figure 3-15 Constraints and comment

3.16.4 Mapping

A constraint string is a string enclosed in braces (**{ }**).

The constraint string maps into the *body* expression in a Constraint element. The mapping depends on the language of the expression, which is known to a tool but generally not displayed on a diagram.

A constraint string following a list entry maps into a Constraint attached to the element corresponding to the list entry.

A constraint string represented as a stand-alone list element maps into a separate Constraint attached to each succeeding model element corresponding to subsequent list entries (until superseded by another constraint or property string).

A constraint string placed near a graphical symbol must be attached to the symbol by a hidden link by a tool operating in context. The tool must maintain the graphical linkage implicitly. The constraint string maps into a Constraint attached to the element corresponding to the symbol.

A constraint string attached to a dashed arrow maps into a constraint attached to the two elements corresponding to the symbols connected by the arrow.

A string enclosed in braces in a note symbol maps into a Constraint attached to the elements corresponding to the symbols connected to the note symbol by dashed lines.

A string (not enclosed in braces) in a note attached to the symbol for an element maps into a Comment attached to the corresponding element.

3.17 Element Properties

Many kinds of elements have detailed properties that do not have a visual notation. In addition, users can define new element properties using the *tagged value* mechanism.

A string may be used to display properties attached to a model element. This includes properties represented by attributes in the metamodel as well as both predefined and user-defined tagged values.

3.17.1 Semantics

Note that we use *property* in a general sense to mean any value attached to a model element, including attributes, associations, and tagged values. In this sense it can include indirectly reachable values that can be found starting at a given element. Some kinds of properties would have syntax within expressions (not specified by UML) but no explicit UML notation.

A *tagged value* is a keyword-value pair that may be attached to any kind of model element (including diagram elements as well as semantic model elements). The keyword is called a *tag*. Each tag represents a particular kind of property applicable to one or many kinds of model elements. Both the tag and the value are encoded as strings. Tagged values are an extensibility mechanism of UML permitting arbitrary information to be attached to models. It is expected that most model editors will provide basic facilities for defining, displaying, and searching tagged values as strings but will not otherwise use them to extend the UML semantics. It is expected, however, that back-end tools such as code generators, report writers, and the like will read tagged values to guide their semantics in flexible ways.

3.17.2 Notation

A property (either a metamodel attribute or a tagged value) is displayed as a comma-delimited sequence of *property specifications* all inside a pair of braces ({ }).

3 UML Notation

A *property specification* has the form

name = value

where *name* is the name of a property (metamodel attribute or arbitrary tag) and *value* is an arbitrary string that denotes its value. If the type of the property is Boolean, then the default value is **true** if the value is omitted. That is, to specify a value of true you may include just the keyword. To specify a value of false, you omit the name completely. Properties of other types require explicit values. The syntax for displaying the value is a tool responsibility in cases where the underlying model value is not a string or a number.

Note that property strings may be used to display built-in attributes as well as tagged values.

Boolean properties frequently have the form *isName*, where *name* is the name of some condition that may be true or false. In these cases, the form “*name*” may usually appear by itself, without a value, to mean “*isName* = true”. For example, {abstract} is the same as {isAbstract = true}.

3.17.3 Presentation Options

A tool may present property specifications on separate lines with or without the enclosing braces, provided they are marked appropriately to distinguish them from other information. For example, properties for a class might be listed under the class name in a distinctive typeface, such as italics or a different font family.

3.17.4 Style Guidelines

It is legal to use strings to specify properties that have graphical notations; however, such usage may be confusing and should be used with care.

3.17.5 Example

```
{ author = "Joe Smith", deadline = 31-March-1997, status = analysis }  
{ abstract }
```

3.17.6 Mapping

Each term within a string maps to either a built-in attribute of a model element or a tagged value (predefined or user-defined). A tool must enforce the correspondence to built-in attributes.

3.18 Stereotypes

3.18.1 Semantics

A stereotype is, in effect, a new class of metamodel element that is introduced at modeling time. It represents a subclass of an existing metamodel element with the same form (attributes and relationships) but with a different intent. Generally a stereotype represents a usage

distinction. A stereotyped element may have additional constraints on it from the base metamodel class. It may also have required tagged values that add information needed by elements with the stereotype. It is expected that code generators and other tools will treat stereotyped elements specially. Stereotypes represent one of the built-in extensibility mechanisms of UML.

3.18.2 Notation

The general presentation of a stereotype is to use the symbol for the metamodel base element but to place a keyword string above the name of the element (if any). The keyword string (Section 3.9, “Keywords,” on page 3-12) is the name of the stereotype within matched *guillemets*, which are the quotation mark symbols used in French and certain other languages (for example, «foo»).

Note – A guillemet looks like a double angle-bracket, but it is a single character in most extended fonts. Most computers have a Character Map utility. Double angle-brackets may be used as a substitute by the typographically challenged.

The keyword string is generally placed above or in front of the name of the model element being described. The keyword string may also be used as an element in a list, in which case it applies to subsequent list elements until another stereotype string replaces it, or an empty stereotype string («») nullifies it. Note that a stereotype name should not be identical to a predefined keyword applicable to the same element type.

To permit limited graphical extension of the UML notation as well, a graphic icon or a graphic marker (such as texture or color) can be associated with a stereotype. The UML does not specify the form of the graphic specification, but many bitmap and stroked formats exist (and their portability is a difficult problem). The icon can be used in one of two ways:

1. It may be used instead of, or in addition to, the stereotype keyword string as part of the symbol for the base model element that the stereotype is based on. For example, in a class rectangle it is placed in the upper right corner of the name compartment. In this form, the normal contents of the item can be seen.
2. The entire base model element symbol may be “collapsed” into an icon containing the element name or with the name above or below the icon. Other information contained by the base model element symbol is suppressed. More general forms of icon specification and substitution are conceivable, but we leave these to the ingenuity of tool builders, with the warning that excessive use of extensibility capabilities may lead to loss of portability among tools.

UML avoids the use of graphic markers, such as color, that present challenges for certain persons (the color blind) and for important kinds of equipment (such as printers, copiers, and fax machines). None of the UML symbols *require* the use of such graphic markers. Users *may* use graphic markers freely in their personal work for their own purposes (such as for highlighting within a tool) but should be aware of their limitations for interchange and be prepared to use the canonical forms when necessary.

3 UML Notation

The classification hierarchy of the stereotypes themselves can be displayed on a class diagram, as described in Section 3.34, “Stereotype,” on page 3-54. This capability is not required by many modelers who must use existing stereotypes but not define new kinds of stereotypes.

3.18.3 Example

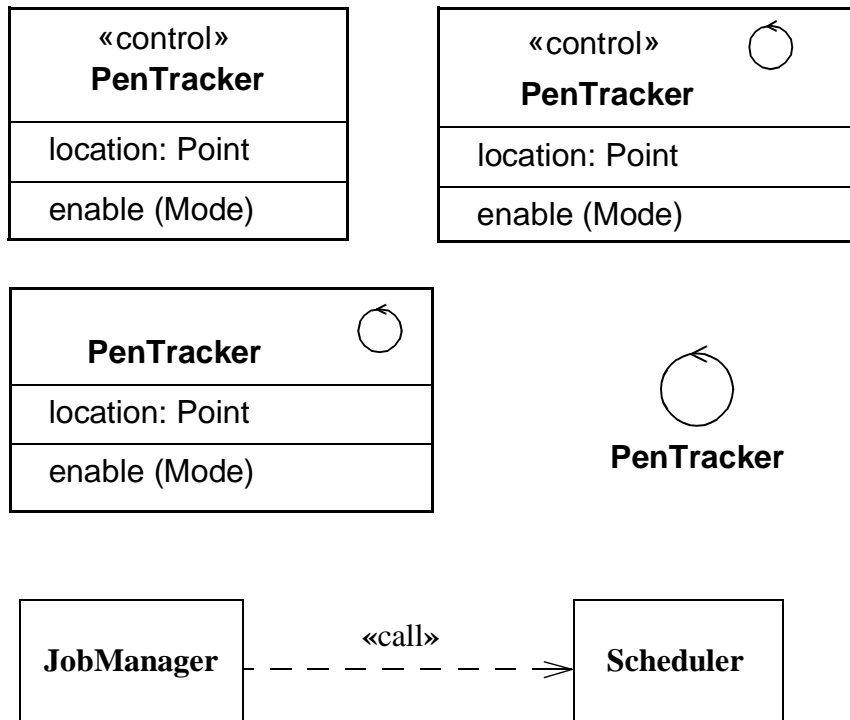

Figure 3-16 Varieties of Stereotype Notation

3.18.4 Mapping

The use of a stereotype keyword maps into the stereotype relationship between the Element corresponding to the symbol containing the name and the Stereotype of the given name. The use of a stereotype icon within a symbol maps into the stereotype relationship between the Element corresponding to the symbol containing the icon and the Stereotype represented by the symbol. A tool must establish the connection when the symbol is created and there is no requirement that an icon represent uniquely one stereotype. The use of a stereotype icon, instead of a symbol, must be created in a context in which a tool implies a corresponding model element and a Stereotype represented by the icon. The element and the stereotype have the stereotype relationship.

Part 5 - Static Structure Diagrams

Class diagrams show the static structure of the model, in particular, the things that exist (such as classes and types), their internal structure, and their relationships to other things. Class diagrams do not show temporal information, although they may contain reified occurrences of things that have or things that describe temporal behavior. An object diagram shows instances compatible with a particular class diagram.

This section discusses classes and their variations, including templates and instantiated classes, and the relationships between classes (association and generalization) and the contents of classes (attributes and operations).

3.19 Class Diagram

A class diagram is a graph of Classifier elements connected by their various static relationships. Note that a “class” diagram may also contain interfaces, packages, relationships, and even instances, such as objects and links. Perhaps a better name would be “static structural diagram” but “class diagram” is shorter and well established.

3.19.1 Semantics

A class diagram is a graphic view of the static structural model. The individual class diagrams do not represent divisions in the underlying model.

3.19.2 Notation

A class diagram is a collection of (static) declarative model elements, such as classes, interfaces, and their relationships, connected as a graph to each other and to their contents. Class diagrams may be organized into packages either with their underlying models or as separate packages that build upon the underlying model packages.

3.19.3 Mapping

A class diagram does not necessarily match a single semantic entity. A package within the static structural model may be represented by one or more class diagrams. The division of the presentation into separate diagrams is for graphical convenience and does not imply a partitioning of the model itself. The contents of a diagram map into elements in the static semantic model. If a diagram is part of a package, then its contents map into elements in the same package (including possible references to elements accessed or imported from other packages).

3 UML Notation

3.20 Object Diagram

An object diagram is a graph of instances, including objects and data values. A static object diagram is an instance of a class diagram; it shows a snapshot of the detailed state of a system at a point in time. The use of object diagrams is fairly limited, mainly to show examples of data structures.

Tools need not support a separate format for object diagrams. Class diagrams can contain objects, so a class diagram with objects and no classes is an “object diagram.” The phrase is useful, however, to characterize a particular usage achievable in various ways.

3.21 Classifier

Classifier is the metamodel superclass of *Class*, *DataType*, and *Interface*. All of these have similar syntax and are therefore all notated using the rectangle symbol with keywords used as necessary. Because classes are most common in diagrams, a rectangle without a keyword represents a class, and the other subclasses of *Classifier* are indicated with keywords. In the sections that follow, the discussion will focus on *Class*, but most of the notation applies to the other element kinds as semantically appropriate and as described later under their own sections.

3.22 Class

A *class* is the descriptor for a set of objects with similar structure, behavior, and relationships. The model is concerned with describing the intension of the class, that is, the rules that define it. The run-time execution provides its extension, that is, its instances. UML provides notation for declaring classes and specifying their properties, as well as using classes in various ways. Some modeling elements that are similar in form to classes (such as interfaces, signals, or utilities) are notated using keywords on class symbols; some of these are separate metamodel classes and some are stereotypes of *Class*. Classes are declared in class diagrams and used in most other diagrams. UML provides a graphical notation for declaring and using classes, as well as a textual notation for referencing classes within the descriptions of other model elements.

3.22.1 Semantics

A class represents a concept within the system being modeled. Classes have data structure and behavior and relationships to other elements.

The name of a class has scope within the package in which it is declared and the name must be unique (among class names) within its package.

3.22.2 Basic Notation

A class is drawn as a solid-outline rectangle with three compartments separated by horizontal lines. The top name compartment holds the class name and other general properties of the class (including stereotype); the middle list compartment holds a list of attributes; the bottom list compartment holds a list of operations.

See “Name Compartment” on page 3-36 and “List Compartment” on page 3-37 for more details.

References

By default a class shown within a package is assumed to be defined within that package. To show a reference to a class defined in another package, use the syntax

Package-name::Class-name

as the name string in the name compartment. A full pathname can be specified by chaining together package names separated by double colons (::).

3.22.3 *Presentation Options*

Either or both of the attribute and operation compartments may be suppressed. A separator line is not drawn for a missing compartment. If a compartment is suppressed, no inference can be drawn about the presence or absence of elements in it. Compartment names can be used to remove ambiguity, if necessary (“List Compartment” on page 3-37).

Additional compartments may be supplied as a tool extension to show other predefined or user-defined model properties (for example, to show business rules, responsibilities, variations, events handled, exceptions raised, and so on). Most compartments are simply lists of strings. More complicated formats are possible, but UML does not specify such formats; they are a tool responsibility. Appearance of each compartment should preferably be implicit based on its contents. Compartment names may be used, if needed.

Tools may provide other ways to show class references and to distinguish them from class declarations.

A class symbol with a stereotype icon may be “collapsed” to show just the stereotype icon, with the name of the class either inside the class or below the icon. Other contents of the class are suppressed.

3.22.4 *Style Guidelines*

- Center class name in boldface.
- Center keyword (including stereotype names) in plain face within guillemets above class name.
- Begin class names with an uppercase letter.
- Left justify attributes and operations in plain face.
- Begin attribute and operation names with a lowercase letter.
- Show the names of abstract classes or the signatures of abstract operations in italics.

As a tool extension, boldface may be used for marking special list elements (for example, to designate candidate keys in a database design). This might encode some design property modeled as a tagged value, for example.

3 UML Notation

Show full attributes and operations when needed and suppress them in other contexts or references.

3.22.5 Example

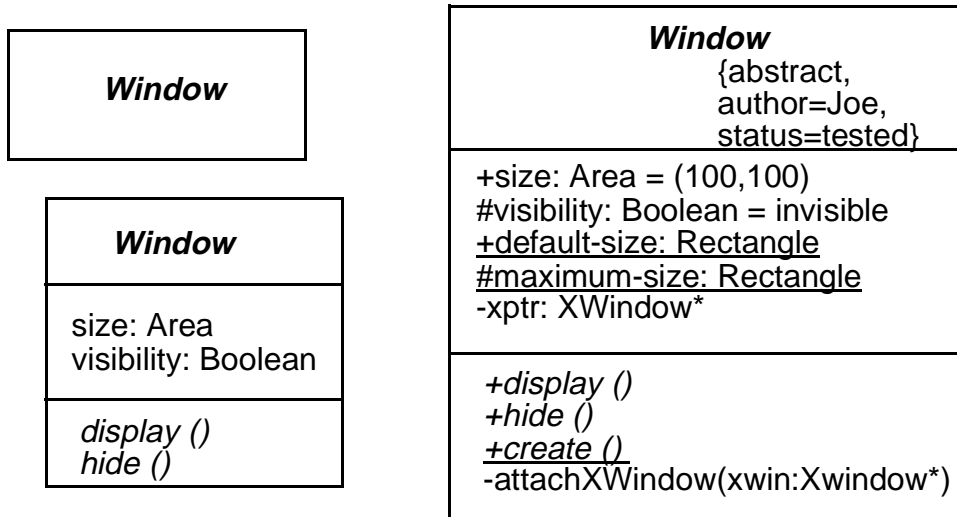

Figure 3-17 Class Notation: Details Suppressed, Analysis-level Details, Implementation-level Details

3.22.6 Mapping

A class symbol maps into a Class element within the package that owns the diagram. The name compartment contents map into the class name and into properties of the class (built-in attributes or tagged values). The attribute compartment maps into a list of Attributes of the Class. The operation compartment maps into a list of Operations of the Class.

The property string {location=*name*} maps into an implementationLocation association to a Component. The *name* is the name of the containing Component.

3.23 Name Compartment

3.23.1 Notation

The name compartment displays the name of the class and other properties in up to three sections:

An optional stereotype keyword may be placed above the class name within guillemets, and/or a stereotype icon may be placed in the upper right corner of the compartment. The stereotype name must not match a predefined keyword.

The name of the class appears next. If the class is abstract, its name appears in italics. Note that any explicit specification of generalization status takes precedence over the name font.

A list of strings denoting properties (metamodel attributes or tagged values) may be placed in braces below the class name. The list may show class-level attributes for which there is no UML notation and it may also show tagged values. The presence of a keyword for a Boolean type without a value implies the value *true*. For example, a leaf class shows the property “{leaf}”.

The stereotype and property list are optional.

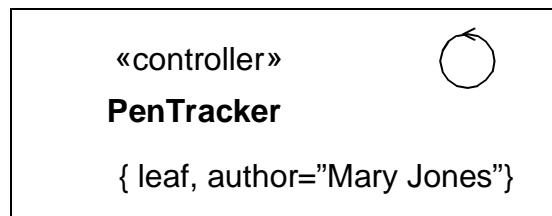

Figure 3-18 Name Compartment

3.23.2 Mapping

The contents of the name compartment map into the name, stereotype, and various properties of the Class represented by the class symbol.

3.24 List Compartment

3.24.1 Notation

A list compartment holds a list of strings, each of which is the encoded representation of a feature, such as an attribute or operation. The strings are presented one to a line with overflow to be handled in a tool-dependent manner. In addition to lists of attributes or operations, optional lists can show other kinds of predefined or user-defined values, such as responsibilities, rules, or modification histories. UML does not define these optional lists. The manipulation of user-defined lists is tool-dependent.

The items in the list are ordered and the order may be modified by the user. The order of the elements is meaningful information and must be accessible within tools (for example, it may be used by a code generator in generating a list of declarations). The list elements may be presented in a different order to achieve some other purpose (for example, they may be sorted in some way). Even if the list is sorted, the items maintain their original order in the underlying model. The ordering information is merely suppressed in the view.

An ellipsis (. . .) as the final element of a list or the final element of a delimited section of a list indicates that additional elements in the model exist that meet the selection condition, but that are not shown in that list. Such elements may appear in a different view of the list.

Group properties

A property string may be shown as a element of the list, in which case it applies to all of the succeeding list elements until another property string appears as a list element. This is equivalent to attaching the property string to each of the list elements individually. The property string does not designate a model element. Examples of this usage include indicating a stereotype and specifying visibility. Keyword strings may also be used in a similar way to qualify subsequent list elements.

Compartment name

A compartment may display a name to indicate which kind of compartment it is. The name is displayed in a distinctive font centered at the top of the compartment. This capability is useful if some compartments are omitted or if additional user-defined compartments are added. For a Class, the predefined compartments are named **attributes** and **operations**. An example of a user-defined compartment might be **requirements**. The name compartment in a class must always be present; therefore, it does not require or permit a compartment name.

3.24.2 *Presentation Options*

A tool may present the list elements in a sorted order, in which case the inherent ordering of the elements is not visible. A sort is based on some internal property and does not indicate additional model information. Example sort rules include:

- alphabetical order,
- ordering by stereotype (such as constructors, destructors, then ordinary methods),
- ordering by visibility (public, then protected, then private), etc.

The elements in the list may be filtered according to some selection rule. The specification of selection rules is a tool responsibility. The absence of items from a filtered list indicates that no elements meet the filter criterion, but no inference can be drawn about the presence or absence of elements that do not meet the criterion. However, the ellipsis notation is available to show that invisible elements exist. It is a tool responsibility whether and how to indicate the presence of either local or global filtering, although a stand-alone diagram should have some indication of such filtering if it is to be understandable.

If a compartment is suppressed, no inference can be drawn about the presence or absence of its elements. An empty compartment indicates that no elements meet the selection filter (if any).

Note that attributes may also be shown by composition (see Figure 3-36 on page 3-77).

3.24.3 Example

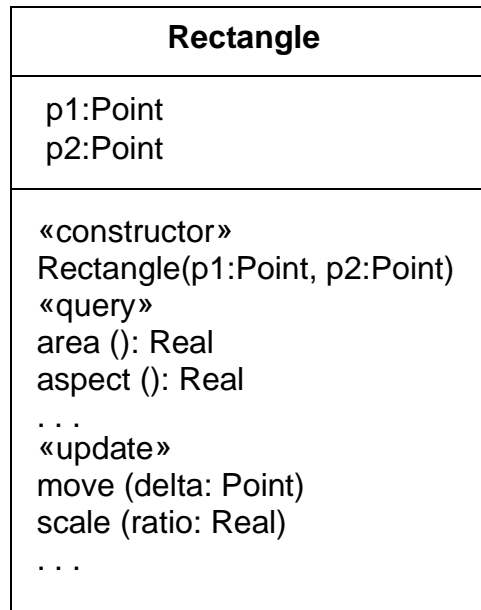

Figure 3-19 Stereotype Keyword Applied to Groups of List Elements

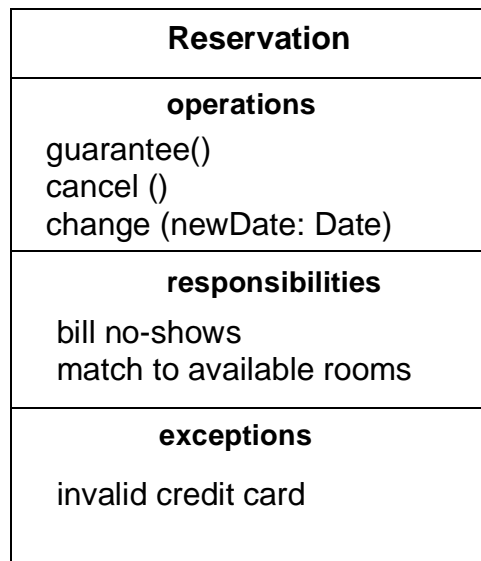

Figure 3-20 Compartments with Names

3 UML Notation

3.24.4 Mapping

The entries in a list compartment map into a list of ModelElements, one for each list entry. The ordering of the ModelElements matches the list compartment entries (unless the list compartment is sorted in some way). In this case, no implication about the ordering of the Elements can be made (the ordering can be seen by turning off sorting). However, a list entry string that is a stereotype indication (within guillemets) or a property indication (within braces) does not map into a separate ModelElement. Instead, the corresponding property applies to each subsequent ModelElement until the appearance of a different stand-alone stereotype or property indicator. The property specifications are conceptually duplicated for each list Element, although a tool might maintain an internal mechanism to store or modify them together. The presence of an ellipsis (“...”) as a list entry implies that the semantic model contains at least one Element with corresponding properties that is not visible in the list compartment.

3.25 Attribute

Strings in the attribute compartment are used to show attributes in classes. A similar syntax is used to specify qualifiers, template parameters, operation parameters, and so on (some of these omit certain terms).

3.25.1 Semantics

Note that an attribute is semantically equivalent to a composition association; however, the intent and usage is normally different.

The type of an attribute is a TypeExpression. It may resolve to a class name or it may be complex, such as `array[String] of Point`. In any case, the details of the attribute type expressions are not specified by UML. They depend on the expression syntax supported by the particular specification or programming language being used.

3.25.2 Notation

An attribute is shown as a text string that can be parsed into the various properties of an attribute model element. The default syntax is:

visibility name [multiplicity] : type-expression = initial-value { property-string }

- Where *visibility* is one of:
 - + public visibility
 - # protected visibility
 - private visibility

The visibility marker may be suppressed. The absence of a visibility marker indicates that the visibility is not shown (not that it is undefined or public). A tool should assign visibilities to new attributes even if the visibility is not shown. The visibility marker is a shorthand for a full *visibility* property specification string.

Visibility may also be specified by keywords (*public*, *protected*, *private*). This form is used particularly when it is used as an inline list element that applies to an entire block of attributes.

Additional kinds of visibility might be defined for certain programming languages, such as C++ *implementation* visibility (actually all forms of nonpublic visibility are language-dependent). Such visibility must be specified by property string or by a tool-specific convention.

- Where *name* is an identifier string that represents the name of the attribute.
- Where [*multiplicity*] shows the multiplicity of the attribute (Section 3.43, “Multiplicity,” on page 3-68). The term may be omitted, in which case the multiplicity is 1..1 (exactly one).
- Where *type-expression* is a language-dependent specification of the implementation type of an attribute.
- Where *initial-value* is a language-dependent expression for the initial value of a newly created object. The initial value is optional (the equal sign is also omitted). An explicit constructor for a new object may augment or modify the default initial value.
- Where *property-string* indicates property values that apply to the element. The property string is optional (the braces are omitted if no properties are specified).

A class-scope attribute is shown by underlining the name and type expression string; otherwise, the attribute is instance-scope.

class-scope-attribute

The notation justification is that a class-scope attribute is an instance value in the executing system, just as an object is an instance value, so both may be designated by underlining. An instance-scope attribute is not underlined; that is the default.

There is no symbol for whether an attribute is changeable (the default is changeable). A nonchangeable attribute is specified with the property “{frozen}”.

In the absence of a multiplicity indicator, an attribute holds exactly 1 value. Multiplicity may be indicated by placing a multiplicity indicator in brackets after the attribute name, for example:

```
colors [3]: Color  
points [2..*]: Point
```

Note that a multiplicity of 0..1 provides for the possibility of null values: the absence of a value, as opposed to a particular value from the range. For example, the following declaration permits a distinction between the *null* value and the empty string:

```
name [0..1]: String
```

A stereotype keyword in guillemets precedes the entire attribute string, including any visibility indicators. A property list in braces follows the rest of the attribute string.

3.25.3 Presentation Options

The type expression may be suppressed (but it has a value in the model).

3 UML Notation

The initial value may be suppressed, and it may be absent from the model. It is a tool responsibility whether and how to show this distinction.

A tool may show the visibility indication in a different way, such as by using a special icon or by sorting the elements by group.

A tool may show the individual fields of an attribute as columns rather than a continuous string.

The syntax of the attribute string can be that of a particular programming language, such as C++ or Smalltalk. Specific tagged properties may be included in the string.

Particular attributes within a list may be suppressed (see “List Compartment” on page 3-37).

3.25.4 Style Guidelines

Attribute names typically begin with a lowercase letter. Attribute names are in plain face.

3.25.5 Example

```
+size: Area = (100,100)
#visibility: Boolean = invisible
+default-size: Rectangle
#maximum-size: Rectangle
-xptr: XWindowPtr
```

3.25.6 Mapping

A string entry within the attribute compartment maps into an Attribute within the Class corresponding to the class symbol. The properties of the attribute map in accord with the preceding descriptions. If the visibility is absent, then no conclusion can be drawn about the Attribute visibilities unless a filter is in effect (e.g., only public attributes shown). Likewise, if the type or initial value are omitted. The omission of an underline always indicates an instance-scope attribute. The omission of multiplicity denotes a multiplicity of 1.

Any properties specified in braces following the attribute string map into properties on the Attribute. In addition, any properties specified on a previous stand-alone property specification entry apply to the current Attribute (and to others).

3.26 Operation

Entries in the operation compartment are strings that show operations defined on classes, and methods supplied by classes.

3.26.1 Semantics

An operation is a service that an instance of the class may be requested to perform. It has a name and a list of arguments.

3.26.2 Notation

An operation is shown as a text string that can be parsed into the various properties of an operation model element. The default syntax is:

visibility name (parameter-list) : return-type-expression { property-string }

- Where *visibility* is one of:
 - + public visibility
 - # protected visibility
 - private visibility

The visibility marker may be suppressed. The absence of a visibility marker indicates that the visibility is not shown (not that it is undefined or public). The visibility marker is a shorthand for a full *visibility* property specification string.

Visibility may also be specified by keywords (*public*, *protected*, *private*). This form is used particularly when it is used as an inline list element that applies to an entire block of operations.

Additional kinds of visibility might be defined for certain programming languages, such as C++ *implementation* visibility (actually all forms of nonpublic visibility are language-dependent). Such visibility must be specified by property string or by a tool-specific convention.

- Where *name* is an identifier string.
- Where *return-type-expression* is a language-dependent specification of the implementation type or types of the value returned by the operation. The the colon and the return-type are omitted if the operation does not return a value (as for C++ void). A list of expressions may be supplied to indicate multiple return values.
- Where *parameter-list* is a comma-separated list of formal parameters, each specified using the syntax:

kind name : type-expression = default-value

- where *kind* is **in**, **out**, or **inout**, with the default **in** if absent.
 - where *name* is the name of a formal parameter.
 - where *type-expression* is the (language-dependent) specification of an implementation type.
 - where *default-value* is an optional value expression for the parameter, expressed in and subject to the limitations of the eventual target language.
- Where *property-string* indicates property values that apply to the element. The property string is optional (the braces are omitted if no properties are specified).

A class-scope operation is shown by underlining the name and type expression string. An instance-scope operation is the default and is not marked.

An operation that does not modify the system state (one that has no side effects) is specified by the property “{query}”; otherwise, the operation may alter the system state, although there is no guarantee that it will do so.

3 UML Notation

The concurrency semantics of an operation are specified by a property string of the form “{concurrency = *name*}, where *name* is one of the names: *sequential*, *guarded*, *concurrent*. As a shorthand, one of the names may be used by itself in a property string to indicate the corresponding concurrency value. In the absence of a specification, the concurrency semantics are unspecified and must therefore be assumed to be sequential in the worst case.

The top-most appearance of an operation signature declares the operation on the class (and inherited by all of its descendents). If this class does not implement the operation (i.e., does not supply a method), then the operation may be marked as “{abstract}” or the operation signature may be italicized to indicate that it is abstract. A subordinate appearance of the operation signature without the {abstract} property indicates that the subordinate class implements a method on the operation.

The actual text or algorithm of a method may be indicated in a note attached to the operation entry.

If the objects of a class accept and respond to a given signal, an operation entry with the keyword «signal» indicates that the class accepts the given signal. The syntax is identical to that of an operation. The response of the object to the reception of the signal is shown with a state machine. Among other uses, this notation can show the response of objects of a class to error conditions and exceptions, which should be modeled as signals.

The specification of operation behavior is given as a note attached to the operation. The text of the specification should be enclosed in braces if it is a formal specification in some language (a semantic Constraint); otherwise, it should be plain text if it is just a natural-language description of the behavior (a Comment).

A stereotype keyword in guillemets precedes the entire operation string, including any visibility indicators. A property list in braces follows the entire operation string.

3.26.3 Presentation Options

The argument list and return type may be suppressed (together, not separately).

A tool may show the visibility indication in a different way, such as by using a special icon or by sorting the elements by group.

The syntax of the operation signature string can be that of a particular programming language, such as C++ or Smalltalk. Specific tagged properties may be included in the string.

A method body may be shown in a note attached to the operation entry within the compartment (Figure 3-21 on page 45). The line is drawn to the string within the compartment. This approach is useful mainly for showing small method bodies.

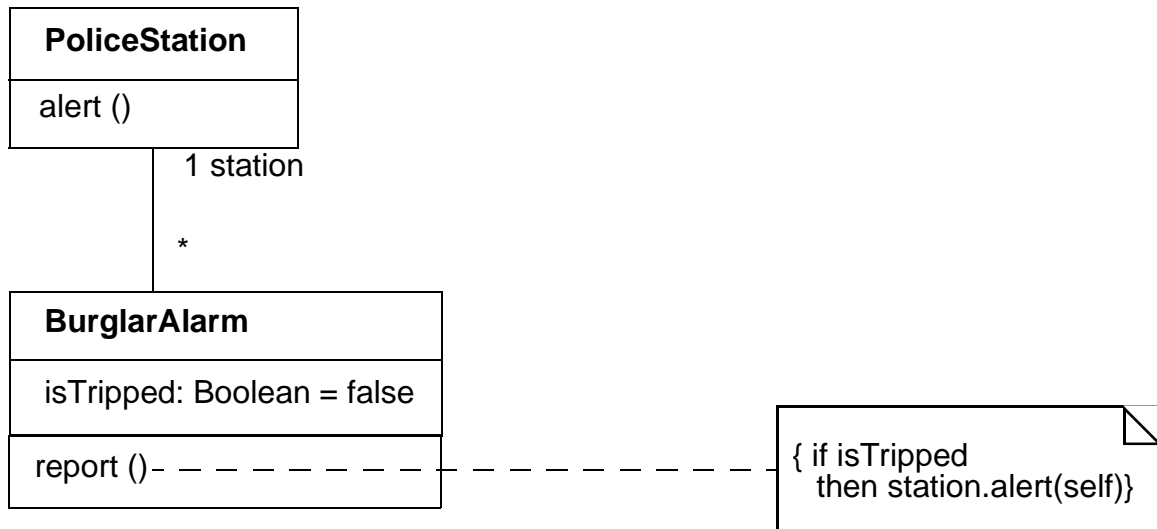

Figure 3-21 Note showing method body

3.26.4 Style Guidelines

Operation names typically begin with a lowercase letter. Operation names are in plain face. An abstract operation may be shown in italics.

3.26.5 Example

```

+display (): Location
+hide ()
+create ()
-attachXWindow(xwin:Xwindow*)
    
```

Figure 3-22 Operation List with a Variety of Operations

3.26.6 Mapping

A string entry within the operation compartment maps into an Operation or a Method within the Class corresponding to the class symbol. The properties of the operation map in accordance with the preceding descriptions. See the description of “Attribute” on page 3-40 for additional details. Parameters without keywords map into Parameters with kind=in, otherwise according to the keyword. Return value names may into Parameters with kind=return.

If the entry has the keyword «signal», then it maps into a Reception on the Class instead.

3 UML Notation

The topmost appearance of an operation specification in a class hierarchy maps into an Operation definition in the corresponding Class or Interface. Interfaces do not have methods. In a Class, each appearance of an operation entry maps into the presence of a Method in the corresponding Class, unless the operation entry contains the {abstract} property (including use of conventions such as italics for abstract operations). If an abstract operation entry appears within a hierarchy in which the same operation has already been defined in an ancestor, it has no effect but is not an error unless the declarations are inconsistent.

Note that the operation string entry does not specify the body of a method.

3.27 Type vs. Implementation Class

3.27.1 Semantics

Classes can be stereotyped as Types or Implementation Classes (although they can be left undifferentiated as well). A Type is used to specify a domain of objects together with operations applicable to the objects without defining the physical implementation of those objects. A Type may not include any methods, but it may provide behavioral specifications for its operations. It may also have attributes and associations that are defined solely for the purpose of specifying the behavior of the type's operations and do not represent any actual implementation of state data.

An Implementation Class defines the physical data structure (for attributes and associations) and methods of an object as implemented in traditional languages (C++, Smalltalk, etc.). An Implementation Class is said to *realize* a Type if it provides all of the operations defined for the Type with the same behavior as specified for the Type's operations. An Implementation Class may realize a number of different Types. Note that the physical attributes and associations of the Implementation Class do not have to be the same as those of any Type it realizes and that the Implementation Class may provide methods for its operations in terms of its physical attributes and associations.

An object may have at most one Implementation Class, since this specifies the physical implementation of the object. However, an object may conform to multiple different Types. If the object has an Implementation Class, then that Implementation Class should realize the Types to which the object conforms. If dynamic classification is used, then the Types to which an object conforms may actually change dynamically. A Type may be used in this way to characterize a changeable role that an object may adopt and later abandon.

Although the use of types and implementation classes is different, their internal structure is the same and they are both classifiers of objects. Therefore they are modeled as stereotypes of classes. As such, they both fully support the usual generalization/specialization and the inheritance of attributes, associations and operations. Note, however, the types may only specialize other types and implementation classes may only specialize other implementation classes. Types and implementation classes can be related only by realization.

3.27 Type vs. Implementation Class

3.27.2 Notation

An undifferentiated class is shown with no stereotype. A type is shown with the stereotype “«type»”. An implementation class is shown with the stereotype “«implementationClass»”. A tool is also free to allow a default setting for an entire diagram, in which case all of the class symbols without explicit stereotype indications map into Classes with the default stereotype. This might be useful for a model that is close to the programming level.

The implementation of a type by a class is modeled as the Realization relationship, shown as a dashed line with a solid triangular arrowhead (a dashed “generalization arrow”). This symbol implies the realizing class provides at least all the operations of the Type, with conforming behavior, but it does not imply inheritance of structure (attributes or associations). The generalization hierarchy of a set of classes frequently parallels the generalization hierarchy of a set of types that they realize, but this is not mandatory, as long as each class provides the operations of the types that it realizes.

3.27.3 Example

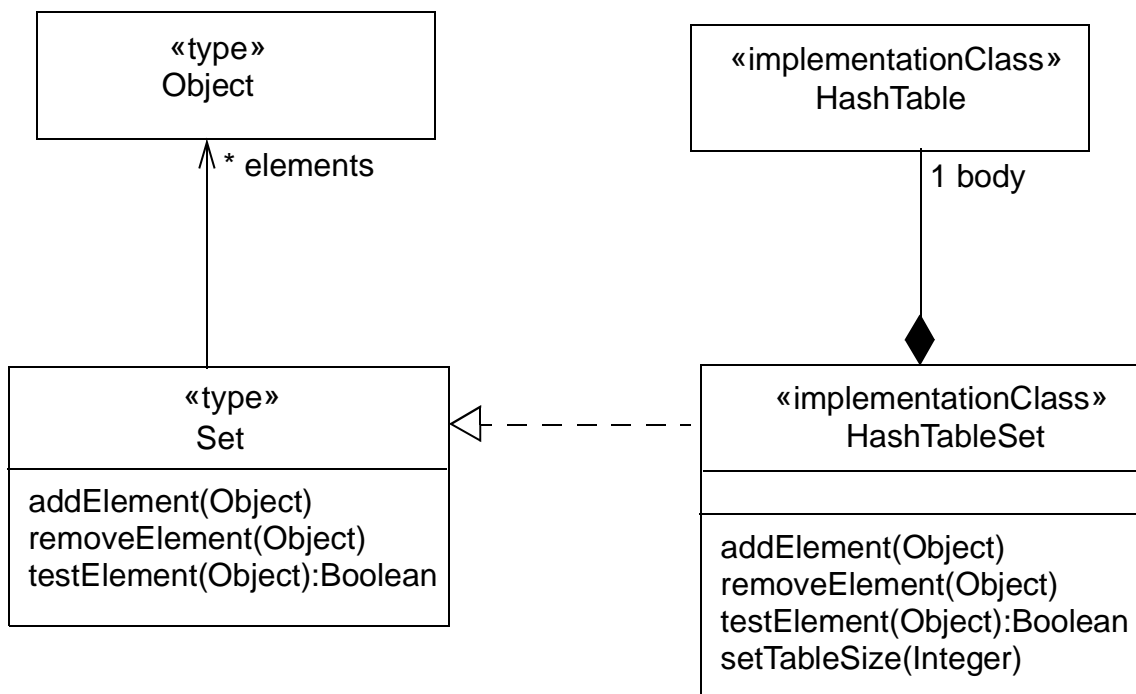

Figure 3-23 Notation for Types and Implementation Classes

3 UML Notation

3.27.4 Mapping

A class symbol with a stereotype (including “type” and “implementationClass”) maps into a Class with the corresponding stereotype. A class symbol without a stereotype maps into a Class with the default stereotype for the diagram (if a default has been defined by the modeler or tool); otherwise, it maps into a Class with no stereotype. The realization arrow between two symbols maps into an Abstraction relationship, with the «realize» stereotype, between the Classifiers corresponding to the two symbols. Realization is usually used between a class and an interface, but may also be used between any two classifiers to show conformance of behavior.

3.28 Interfaces

3.28.1 Semantics

An interface is a specifier for the externally-visible operations of a class, component, or other classifier (including subsystems) without specification of internal structure. Each interface often specifies only a limited part of the behavior of an actual class. Interfaces do not have implementation. They lack attributes, states, or associations; they only have operations. (An interface may be the target of a one-way association, however, but it may not have an association that it can navigate.) Interfaces may have generalization relationships. An interface is formally equivalent to an abstract class with no attributes and no methods and only abstract operations, but Interface is a peer of Class within the UML metamodel (both are Classifiers).

3.28.2 Notation

An interface is a Classifier and may be shown using the full rectangle symbol with compartments and the keyword «interface». A list of operations supported by the interface is placed in the operation compartment. The attribute compartment may be omitted because it is always empty.

An interface may also be displayed as a small circle with the name of the interface placed below the symbol. The circle may be attached by a solid line to classifiers that support it. This indicates that the class provides all of the operations in the interface type (and possibly more). The operations provided are not shown on the circle notation; use the full rectangle symbol to show the list of operations. A class that uses or requires the operations supplied by the interface may be attached to the circle by a dashed arrow pointing to the circle. The dashed arrow implies that the class requires no more than the operations specified in the interface; the client class is not required to actually use *all* of the interface operations.

The Realization relationship from a classifier to an interface that it supports is shown by a dashed line with a solid triangular arrowhead (a “dashed generalization symbol”). This is the same notation used to indicate realization of a type by an implementation class. In fact, this symbol can be used between any two classifier symbols, with the meaning that the client (the one at the tail of the arrow) supports at least all of the operations defined in the supplier (the one at the head of the arrow), but with no necessity to support any of the data structure of the supplier (attributes and associations).

3.29 Parameterized Class (Template)

3.28.3 Example

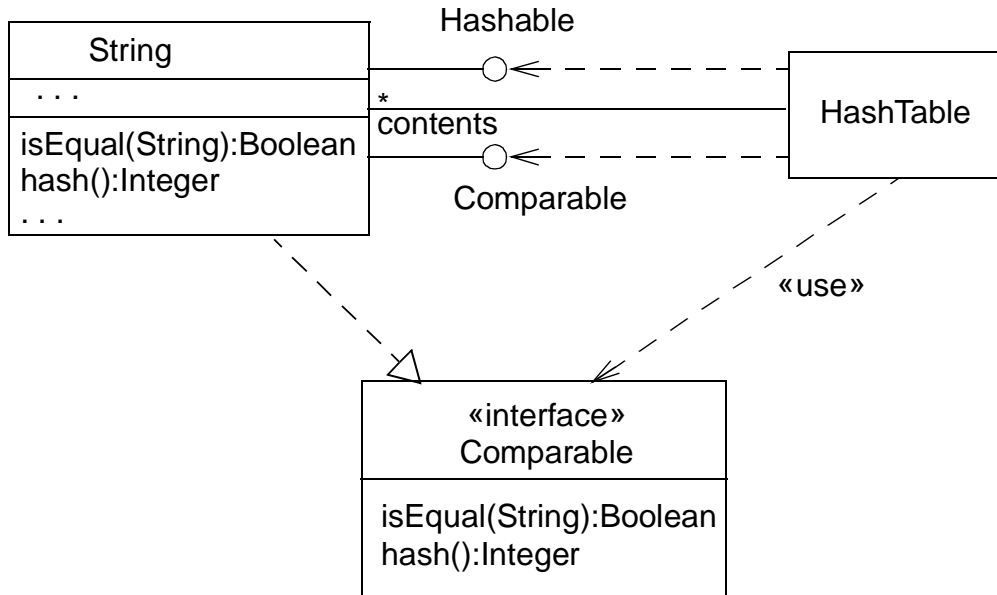

Figure 3-24 Interface Notation on Class Diagram

3.28.4 Mapping

A class rectangle symbol with stereotype `«interface»`, or a circle on a class diagram, maps into an Interface element with the name given by the symbol. The operation list of a rectangle symbol maps into the list of Operation elements of the Interface.

A dashed generalization arrow from a class symbol to an interface symbol, or a solid line connecting a class symbol and an interface circle, maps into a an Abstraction dependency with the `«realize»` stereotype between the corresponding Classifier and Interface elements. A dependency arrow from a class symbol to an interface symbol maps into a Usage dependency between the corresponding Classifier and Interface.

3.29 Parameterized Class (Template)

3.29.1 Semantics

A template is the descriptor for a class with one or more unbound formal parameters. It defines a family of classes, each class specified by binding the parameters to actual values. Typically, the parameters represent attribute types; however, they can also represent integers, other types, or even operations. Attributes and operations within the template are defined in terms of the formal parameters so they too become bound when the template itself is bound to actual values.

3 UML Notation

A template is not a directly usable class because it has unbound parameters. Its parameters must be bound to actual values to create a bound form that is a class. Only a class can be a superclass or the target of an association (a one-way association *from* the template *to* another class is permissible, however). A template may be a subclass of an ordinary class. This implies that all classes formed by binding it are subclasses of the given superclass.

Parameterization can be applied to other ModelElements, such as Collaborations or even entire Packages. The description given here for classes applies to other kinds of modeling elements in the obvious way.

3.29.2 Notation

A small dashed rectangle is superimposed on the upper right-hand corner of the rectangle for the class (or to the symbol for another modeling element). The dashed rectangle contains a parameter list of formal parameters for the class and their implementation types. The list must not be empty, although it might be suppressed in the presentation. The name, attributes, and operations of the parameterized class appear as normal in the class rectangle; however, they may also include occurrences of the formal parameters. Occurrences of the formal parameters can also occur inside of a context for the class, for example, to show a related class identified by one of the parameters.

3.29.3 Presentation Options

The parameter list may be comma-separated or it may be one per line.

Parameters are restricted attributes, shown as strings with the syntax

name : *type* = *default-value*

- Where *name* is an identifier for the parameter with scope inside the template.
- Where *type* is a string designating a *TypeExpression* for the parameter.
- Where *default-value* is a string designating an Expression for a default value that is used when the corresponding argument is omitted in a Binding. The equal sign and expression may be omitted, in which case there is no default value and the argument must be supplied in a Binding.

If the type name is omitted, the parameter type is assumed to be Classifier. The value supplied for an argument in a Binding must be the name of a Classifier (including a class or a data type). Other parameter types (such as `Integer`) must be explicitly shown. The value supplied for an argument in a Binding must be an actual instance value of the given kind.

3.29.4 Example

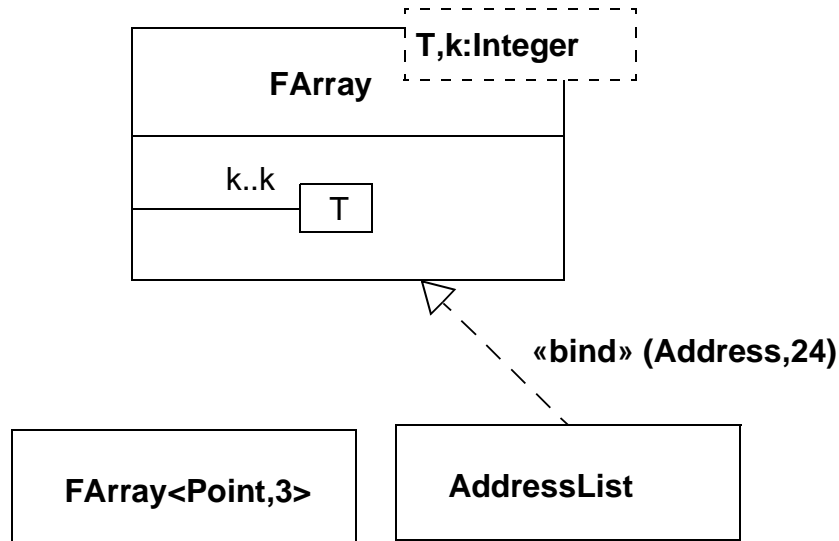

Figure 3-25 Template Notation with Use of Parameter as a Reference

3.29.5 Mapping

The addition of the template dashed box to a symbol causes the addition of the parameter names in the list as ModelElements within the Namespace of the ModelElement corresponding to the base symbol (or to the Namespace containing a ModelElement that is not itself a Namespace). Each of the parameter ModelElements has the templateParameter association to the base ModelElement.

3.30 Bound Element

3.30.1 Semantics

A template cannot be used directly in an ordinary relationship such as generalization or association, because it has a free parameter that is not meaningful outside of a scope that declares the parameter. To be used, a template's parameters must be *bound* to actual values. The actual value for each parameter is an expression defined within the scope of use. If the referencing scope is itself a template, then the parameters of the referencing template can be used as actual values in binding the referenced template. The parameter names in the two templates cannot be assumed to correspond because they have no scope outside of their respective templates.

3 UML Notation

3.30.2 Notation

A bound element is indicated by a text syntax in the name string of an element, as follows:

Template-name '<' *value-list* '>'

- Where *value-list* is a comma-delimited non-empty list of value expressions.
- Where *Template-name* is identical to the name of a template.

For example, `VArray<Point,3>` designates a class described by the template `Varray`.

The number and type of values must match the number and type of the template parameters for the template of the given name.

The bound element name may be used anywhere that an element name of the parameterized kind could be used. For example, a bound class name could be used within a class symbol on a class diagram, as an attribute type, or as part of an operation signature.

Note that a bound element is fully specified by its template; therefore, its content may not be extended. Declaration of new attributes or operations for classes is not permitted, for example, but a bound class could be subclassed and the subclass extended in the usual way.

The relationship between the bound element and its template alternatively may be shown by a Dependency relationship with the keyword `<bind>`. The arguments are shown in parentheses after the keyword. In this case, the bound form may be given a name distinct from the template.

3.30.3 Style Guidelines

The attribute and operation compartments are normally suppressed within a bound class, because they must not be modified in a bound template.

3.30.4 Example

See Figure 3-25 on page 3-51.

3.30.5 Mapping

The use of the bound element syntax for the name of a symbol maps into a Binding dependency between the dependent ModelElement (such as Class) corresponding to the bound element symbol and the provider ModelElement (again, such as Class) whose name matches the name part of the bound element without the arguments. If the name does not match a template element or if the number of arguments in the bound element does not match the number of parameters in the template, then the model is ill formed. Each argument in the bound element maps into a ModelElement bearing an argument link to the Binding dependency. An explicitly drawn `<bind>` dependency symbol maps to a Binding dependency with arguments as described above.

3.31 Utility

A utility is a grouping of global variables and procedures in the form of a class declaration. This is not a fundamental construct, but a programming convenience. The attributes and operations of the utility become global variables and procedures. A utility is modeled as a stereotype of a class.

3.31.1 Semantics

The instance-scope attributes and operations of a utility are interpreted as global attributes and operations. It is inappropriate for a utility to declare class-scope attributes and operations because the instance-scope members are already interpreted as being at class scope.

3.31.2 Notation

A utility is shown as the stereotype «utility» of Class. It may have both attributes and operations, all of which are treated as global attributes and operations.

3.31.3 Example

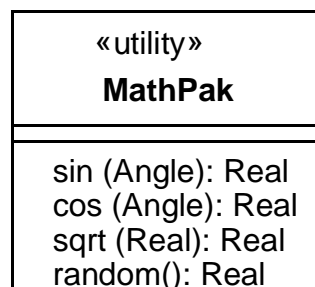

Figure 3-26 Notation for Utility

3.31.4 Mapping

This is not a special symbol. It simply maps into a Class element with the «utility» stereotype.

3.32 Metaclass

3.32.1 Semantics

A metaclass is a class whose instances are classes.

3 UML Notation

3.32.2 Notation

A metaclass is shown as the stereotype «metaclass» of Class.

3.32.3 Mapping

This is not a special symbol. It simply maps into a Class element with the «metaclass» stereotype.

3.33 Enumeration

3.33.1 Semantics

An Enumeration is a user-defined data type whose instances are a set of user-specified named enumeration literals. The literals have a relative order but no algebra is defined on them.

3.33.2 Notation

An Enumeration is shown using the Classifier notation (a rectangle) with the keyword «enumeration». The name of the Enumeration is placed in the upper compartment. An ordered list of enumeration literals may be placed, one to a line, in the middle compartment. Operations defined on the literals may be placed in the lower compartment. The lower and middle compartments may be suppressed.

3.33.3 Mapping

Maps into an Enumeration with the given list of enumeration literals.

3.34 Stereotype

3.34.1 Semantics

A Stereotype is a user-defined metaelement whose structure matches an existing UML metaelement.

3.34.2 Notation

A Stereotype is shown using the Classifier notation (a rectangle) with the keyword «stereotype». The name of the Stereotype is placed in the upper compartment. Constraints on elements described by the stereotype may be placed in a named compartment called **Constraints**. Required tags may be placed in a named compartment called **Tags**.

The base element may be indicated by a property string of the form {baseElement = name}.

An icon can be defined for the stereotype, but its graphical definition is outside the scope of UML and must be handled by an editing tool.

3.34.3 Mapping

Maps into a Stereotype with the given constraints and base element.

3.35 Powertype

3.35.1 Semantics

A Powertype is a user-defined metaelement whose instances are classes in the model.

3.35.2 Notation

A Powertype is shown using the Classifier notation (a rectangle) with the stereotype keyword «powertype». The name of the Powertype is placed in the upper compartment. Because the elements are ordinary classes, attributes and operations on the powertype are usually not defined by the user.

The instances of the powertype may be indicated by placing a dashed line across the parent lines of the classes with the syntax

`discriminatorName: powertypeName,`

where the powertype name on the line implicitly defines a powertype if one is not explicitly defined.

3.35.3 Mapping

Maps into a Class with the «powertype» stereotype with the given classes as instances.

3.36 Class Pathnames

3.36.1 Notation

Class symbols (rectangles) serve to define a class and its properties, such as relationships to other classes. A reference to a class in a different package is notated by using a pathname for the class, in the form:

package-name :: class-name

References to classes also appear in text expressions, most notably in type specifications for attributes and variables. In these places a reference to a class is indicated by simply including the name of the class itself, including a possible package name, subject to the syntax rules of the expression.

3 UML Notation

3.36.2 Example

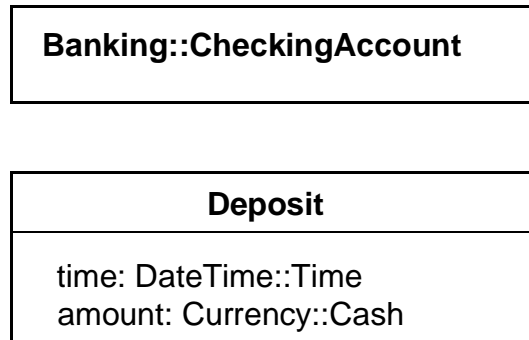

Figure 3-27 Pathnames for Classes in Other Packages

3.36.3 Mapping

A class symbol whose name string is a pathname represents a reference to the Class with the given name inside the package with the given name. The name is assumed to be defined in the target package; otherwise, the model is ill formed. A Relationship from a symbol in the current package (i.e., the package containing the diagram and its mapped elements) to a symbol in another package is part of the current package.

3.37 Accessing or Importing a Package

3.37.1 Semantics

An element may reference an element contained in a different package. On the package level, the «access» dependency indicates that the contents of the target package may be referenced by the client package or packages recursively embedded within it. The target references must have visibility sufficient for the referents: public visibility for an unrelated package, public or protected visibility for a descendant of the target package, or any visibility for a package nested inside the target package (an access dependency is not required for the latter case). A package nested inside the package making the access gets the same access.

Note that an access dependency does not modify the namespace of the client or in any other way automatically create references; it merely grants permission to establish references. Note also that a tool could automatically create access dependencies for users if desired when references are created.

An import dependency grants access and also loads the names with appropriate visibility in the target namespace into the accessing package (i.e., a pathname is not necessary to reference them). Such names are not automatically reexported, however; a name must be explicitly reexported (and may be given a new name and visibility at the same time).

3.37 Accessing or Importing a Package

3.37.2 Notation

The access dependency is displayed as a dependency arrow from the referencing (client) package to the target (supplier) package containing the target of the references. The arrow has the stereotype keyword «access». This dependency indicates that elements within the client package may legally reference elements within the supplier. The references must also satisfy visibility constraints specified by the supplier. Note that the dependency does not automatically create any references. It merely grants permission for them to be established.

The import dependency has the same notation as the access dependency except it has the stereotype keyword «import».

3.37.3 Example

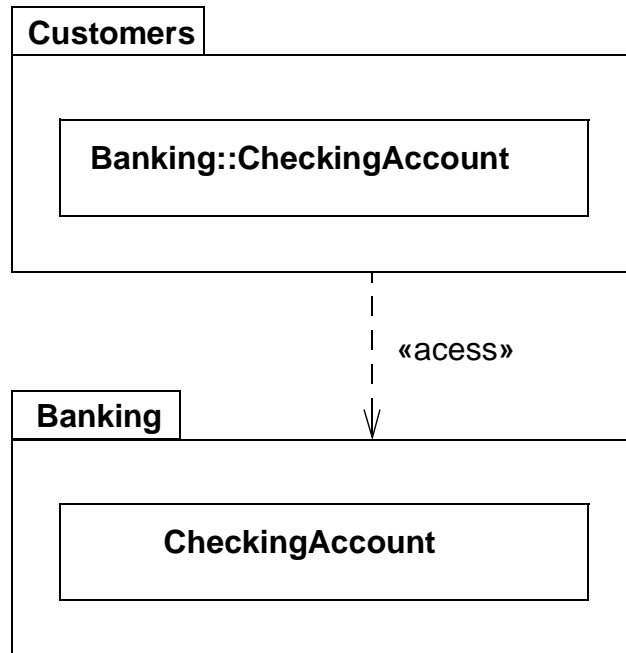

Figure 3-28 Access Dependency Among Packages

3.37.4 Mapping

This is not a special symbol. It maps into a Permission dependency with the stereotype «access» or «import» between the two packages.

3 UML Notation

3.38 Object

3.38.1 Semantics

An object represents a particular instance of a class. It has identity and attribute values. A similar notation also represents a role within a collaboration because roles have instance-like characteristics.

3.38.2 Notation

The object notation is derived from the class notation by underlining instance-level elements, as explained in the general comments in “Type-Instance Correspondence” on page 3-15.

An object shown as a rectangle with two compartments.

The top compartment shows the name of the object and its class, all underlined, using the syntax:

objectname : classname

The classname can include a full pathname of enclosing package, if necessary. The package names precede the classname and are separated by double colons. For example:

```
display_window: WindowingSystem::GraphicWindows::Window
```

A stereotype for the class may be shown textually (in guillemets above the name string) or as an icon in the upper right corner. The stereotype for an object must match the stereotype for its class.

To show multiple classes that the object is an instance of, use a comma-separated list of classnames. These classnames must be legal for multiple classification (i.e., only one implementation class permitted, but multiple types permitted).

To show the presence of an object in a particular state of a class, use the syntax:

objectname : classname [*‘ statename-list ‘*]

The list must be a comma-separated list of names of states that can legally occur concurrently.

The second compartment shows the attributes for the object and their values as a list. Each value line has the syntax:

attributename : type = value

The type is redundant with the attribute declaration in the class and may be omitted.

The value is specified as a literal value. UML does not specify the syntax for literal value expressions; however, it is expected that a tool will specify such a syntax using some programming language.

The flow relationship between two values of the same object over time can be shown by connecting two object symbols by a dashed arrow with the keyword «become». If the flow arrow is on a collaboration diagram, the label may also include a sequence number to show when the value changes. Similarly, the keyword «copy» can be used to show the creation of one object from another object value.

3.38.3 Presentation Options

The name of the object may be omitted. In this case, the colon should be kept with the class name. This represents an anonymous object of the given class given identity by its relationships.

The class of the object may be suppressed (together with the colon).

The attribute value compartment as a whole may be suppressed.

Attributes whose values are not of interest may be suppressed.

Attributes whose values change during a computation may show their values as a list of values held over time. In an interactive tool, they might even change dynamically. An alternate notation is to show the same object more than once with a «becomes» relationship between them.

3.38.4 Style Guidelines

Objects may be shown on class diagrams. The elements on collaboration diagrams are not objects, because they describe many possible objects. They are instead roles that may be held by object. Objects in class diagrams serve mainly to show examples of data structures.

3.38.5 Variations

For a language such as *Self* in which operations can be attached to individual objects at run time, a third compartment containing operations would be appropriate as a language-specific extension.

3 UML Notation

3.38.6 Example

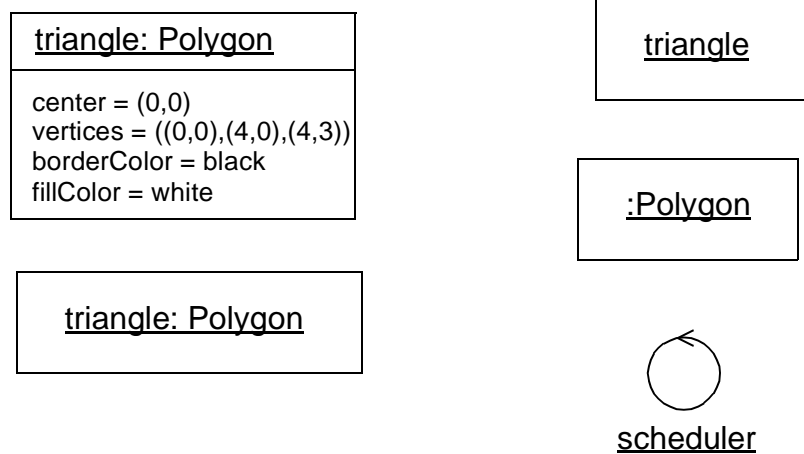

Figure 3-29 Objects

3.38.7 Mapping

In an object diagram, or within an ordinary class diagram, an object symbol maps into an Object of the Class (or Classes) given by the *classname* part of the name string. The attribute list in the symbol maps into a set of AttributeLinks attached to the Object, with values given by the value expressions in the attribute list in the symbol. If a list of states in brackets follows the class name, then this maps into a ClassifierInState with the named Class as its type and the named States as the states.

3.39 Composite Object

3.39.1 Semantics

A composite object represents a high-level object made of tightly-bound parts. This is an instance of a composite class, which implies the composition aggregation between the class and its parts. A composite object is similar to (but simpler and more restricted than) a collaboration; however, it is defined completely by composition in a static model. See Section 3.47, “Composition,” on page 3-74.

3.39.2 Notation

A composite object is shown as an object symbol. The name string of the composite object is placed in a compartment near the top of the rectangle (as with any object). The lower compartment holds the parts of the composite object instead of a list of attribute values. (However, even a list of attribute values may be regarded as the parts of a composite object, so there is not a great difference.) It is possible for some of the parts to be composite objects with further nesting.

3.39.3 Example

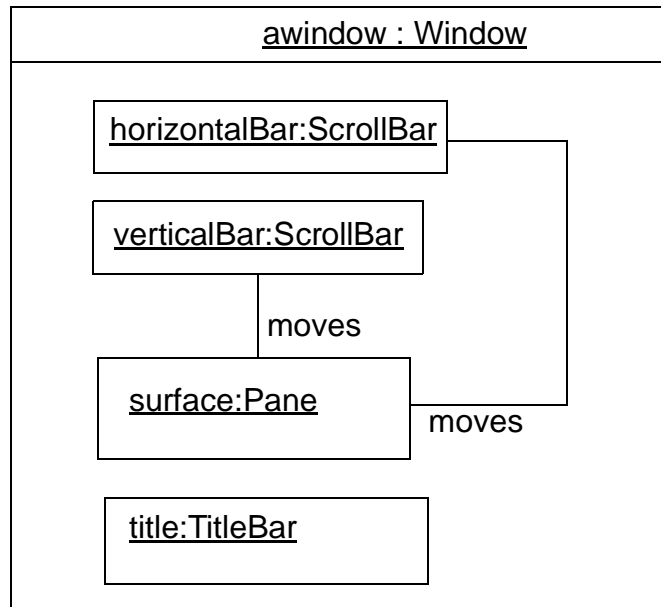

Figure 3-30 Composite Objects

3.39.4 Mapping

A composite object symbol maps into an Object of the given Class with composition links to each of the Objects and Links corresponding to the class box symbols and to association path symbols directly contained within the boundary of the composite object symbol (and not contained within another deeper boundary).

3.40 Association

Binary associations are shown as lines connecting two classifier symbols. The lines may have a variety of adornments to show their properties. Ternary and higher-order associations are shown as diamonds connected to class symbols by lines.

3.41 Binary Association

3.41.1 Semantics

A binary association is an association among exactly two classifiers (including the possibility of an association from a classifier to itself).

3 UML Notation

3.41.2 Notation

A binary association is drawn as a solid path connecting two classifier symbols (both ends may be connected to the same classifier, but the two ends are distinct). The path may consist of one or more connected segments. The individual segments have no semantic significance, but may be graphically meaningful to a tool in dragging or resizing an association symbol. A connected sequence of segments is called a *path*.

In a binary association, both ends may attach to the same classifier. The links of such an association may connect two different instances from the same classifier or one instance to itself. The latter case may be forbidden by a constraint if necessary.

The end of an association where it connects to a classifier is called an *association end*. Most of the interesting information about an association is attached to its ends.

The path may also have graphical adornments attached to the main part of the path itself. These adornments indicate properties of the entire association. They may be dragged along a segment or across segments, but must remain attached to the path. It is a tool responsibility to determine how close association adornments may approach an end so that confusion does not occur. The following kinds of adornments may be attached to a path.

association name

Designates the (optional) name of the association.

It is shown as a name string near the path (but not near enough to an end to be confused with a rolename). The name string may have an optional small black solid triangle in it. The point of the triangle indicates the direction in which to read the name. The name-direction arrow has no semantics significance, it is purely descriptive. The classifiers in the association are ordered as indicated by the name-direction arrow.

Note – There is no need for a *name direction* property on the association model; the ordering of the classifiers within the association *is* the name direction. This convention works even with n-ary associations.

A stereotype keyword within guillemets may be placed above or in front of the association name. A property string may be placed after or below the association name.

association class symbol

Designates an association that has class-like properties, such as attributes, operations, and other associations. This is present if, and only if, the association is an association class. It is shown as a class symbol attached to the association path by a dashed line.

The association path and the association class symbol represent the same underlying model element, which has a single name. The name may be placed on the path, in the class symbol, or on both (but they must be the same name).

Logically, the association class and the association are the same semantic entity; however, they are graphically distinct. The association class symbol can be dragged away from the line, but the dashed line must remain attached to both the path and the class symbol.

3.41.3 Presentation Options

When two paths cross, the crossing may optionally be shown with a small semicircular jog to indicate that the paths do not intersect (as in electrical circuit diagrams).

3.41.4 Style Guidelines

Lines may be drawn using various styles, including orthogonal segments, oblique segments, and curved segments. The choice of a particular set of line styles is a user choice.

3.41.5 Options

Xor-association

An xor-constraint indicates a situation in which only one of several potential associations may be instantiated at one time for any single instance. This is shown as a dashed line connecting two or more associations, all of which must have a classifier in common, with the constraint string "{xor}" labeling the dashed line. Any instance of the classifier may only participate in one of the associations at one time. Each rolename must be different. (This is simply a predefined use of the constraint notation.)

3 UML Notation

3.41.6 Example

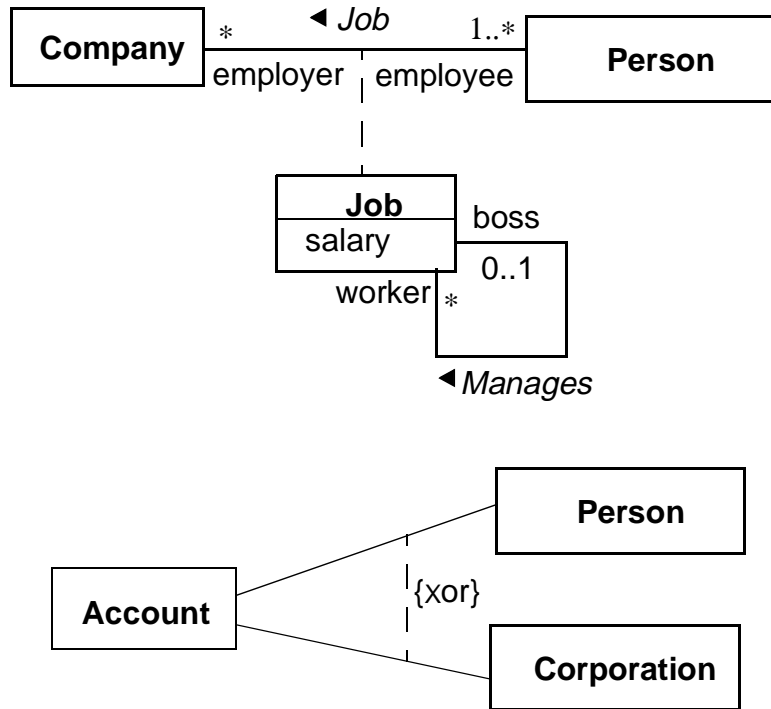

Figure 3-31 Association Notation

3.41.7 Mapping

An association path connecting two class symbols maps to an Association between the corresponding Classifiers. If there is an arrow on the association name, then the Class corresponding to the tail of the arrow is the first class and the Classifier corresponding to the head of the arrow is the second Classifier in the ordering of ends of the Association; otherwise, the ordering of ends in the association is undetermined. The adornments on the path map into properties of the Association as described above. The Association is owned by the package containing the diagram.

3.42 Association End

3.42.1 Semantics

An association end is simply an end of an association where it connects to a classifier. It is part of the association, not part of the classifier. Each association has two or more ends. Most of the interesting details about an association are attached to its ends. An association end is not a separable element, it is just a mechanical part of an association.

3.42.2 Notation

The path may have graphical adornments at each end where the path connects to the classifier symbol. These adornments indicate properties of the association related to the classifier. The adornments are part of the association symbol, not part of the classifier symbol. The end adornments are either attached to the end of the line, or near the end of the line, and must drag with it. The following kinds of adornments may be attached to an association end.

multiplicity

Specified by a text syntax. Multiplicity may be suppressed on a particular association or for an entire diagram. In an incomplete model the multiplicity may be unspecified in the model itself. In this case, it must be suppressed in the notation. See Section 3.43, “Multiplicity,” on page 3-68.

ordering

If the multiplicity is greater than one, then the set of related elements can be ordered or unordered. If no indication is given, then it is unordered (the elements form a set). Various kinds of ordering can be specified as a constraint on the association end. The declaration does not specify how the ordering is established or maintained. Operations that insert new elements must make provision for specifying their position either implicitly (such as at the end) or explicitly. Possible values include:

- unordered - the elements form an unordered set. This is the default and need not be shown explicitly.
- ordered - the elements of the set have an ordering, but duplicates are still prohibited. This generic specification includes all kinds of ordering. This may be specified by the keyword syntax “{ordered}”.

An ordered relationship may be implemented in various ways; however, this is normally specified as a language-specified code generation property to select a particular implementation. An implementation extension might substitute the data structure to hold the elements for the generic specification “ordered.”

At implementation level, sorting may also be specified. It does not add new semantic information, but it expresses a design decision:

3 UML Notation

- sorted - the elements are sorted based on their internal values. The actual sorting rule is best specified as a separate constraint.

qualifier

A qualifier is optional, but not suppressible. See Section 3.44, “Qualifier,” on page 3-70.

navigability

An arrow may be attached to the end of the path to indicate that navigation is supported toward the classifier attached to the arrow. Arrows may be attached to zero, one, or two ends of the path. To be totally explicit, arrows may be shown whenever navigation is supported in a given direction. In practice, it is often convenient to suppress some of the arrows and just show exceptional situations. See “Presentation Options” on page 3-35 for details.

aggregation indicator

A hollow diamond is attached to the end of the path to indicate aggregation. The diamond may not be attached to both ends of a line, but it need not be present at all. The diamond is attached to the class that is the aggregate. The aggregation is optional, but not suppressible.

If the diamond is filled, then it signifies the strong form of aggregation known as *composition*. See Section 3.47, “Composition,” on page 3-74.

rolename

A name string near the end of the path. It indicates the role played by the class attached to the end of the path near the rolename. The rolename is optional, but not suppressible.

interface specifier

The name of a Classifier with the syntax:

`‘:’ classifiername , . . .`

It indicates the behavior expected of an associated object by the related instance. In other words, the interface specifier specifies the behavior required to enable the association. In this case, the actual classifier usually provides more functionality than required for the particular association (since it may have other responsibilities).

The use of a rolename and interface specifier are equivalent to creating a small collaboration that includes just an association and two roles, whose structure is defined by the rolename and attached classifier on the original association. Therefore, the original association and classifiers are a use of the collaboration. The original classifier must be compatible with the interface specifier (which can be an interface or a type, among other kinds of classifiers).

If an interface specifier is omitted, then the association may be used to obtain full access to the associated class.

changeability

If the links are changeable (can be added, deleted, and moved), then no indicator is needed. The property {frozen} indicates that no links may be added, deleted, or moved from an object (toward the end with the adornment) after the object is created and initialized. The property {addOnly} indicates that additional links may be added (presumably, the multiplicity is variable); however, links may not be modified or deleted.

visibility

Specified by a visibility indicator ('+', '#', '-' or explicit property name such as {public}) in front of the rolename. Specifies the visibility of the association traversing in the direction toward the given rolename. See "Attribute" on page 3-40 for details of visibility specification.

Other properties can be specified for association ends, but there is no graphical syntax for them. To specify such properties, use the constraint syntax near the end of the association path (a text string in braces). Examples of other properties include mutability.

3.42.3 *Presentation Options*

If there are two or more aggregations to the same aggregate, they may be drawn as a tree by merging the aggregation end into a single segment. This requires that all of the adornments on the aggregation ends be consistent. This is purely a presentation option, there are no additional semantics to it.

Various options are possible for showing the navigation arrows on a diagram. These can vary from time to time by user request or from diagram to diagram.

- Presentation option 1: Show all arrows. The absence of an arrow indicates navigation is not supported.
- Presentation option 2: Suppress all arrows. No inference can be drawn about navigation. This is similar to any situation in which information is suppressed from a view.
- Presentation option 3: Suppress arrows for associations with navigability in both directions, show arrows only for associations with one-way navigability. In this case, the two-way navigability cannot be distinguished from no-way navigation; however, the latter case is normally rare or nonexistent in practice. This is yet another example of a situation in which some information is suppressed from a view.

3.42.4 *Style Guidelines*

If there are multiple adornments on a single association end, they are presented in the following order, reading from the end of the path attached to the classifier toward the bulk of the path:

- qualifier
- aggregation symbol
- navigation arrow

3 UML Notation

Rolenames and multiplicity should be placed near the end of the path so that they are not confused with a different association. They may be placed on either side of the line. It is tempting to specify that they will always be placed on a given side of the line (clockwise or counterclockwise), but this is sometimes overridden by the need for clarity in a crowded layout. A rolename and a multiplicity may be placed on opposite sides of the same association end, or they may be placed together (for example, “* employee”).

3.42.5 Example

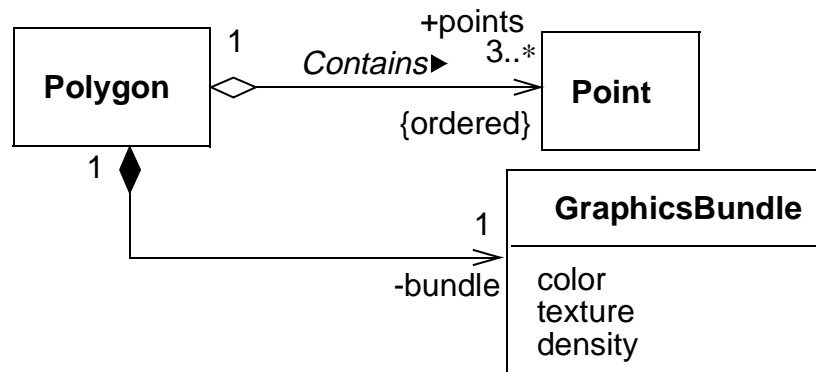

Figure 3-32 Various Adornments on Association Roles

3.42.6 Mapping

The adornments on the end of an association path map into properties of the corresponding role of the Association. In general, implications cannot be drawn from the absence of an adornment (it may simply be suppressed) but see the preceding descriptions for details. The interface specifier maps into the “specification” rolename in the AssociationEnd-Classifier association.

3.43 Multiplicity

3.43.1 Semantics

A multiplicity item specifies the range of allowable cardinalities that a set may assume. Multiplicity specifications may be given for roles within associations, parts within composites, repetitions, and other purposes. Essentially a multiplicity specification is a subset of the open set of nonnegative integers.

3.43.2 Notation

A multiplicity specification is shown as a text string comprising a comma-separated sequence of integer intervals, where an interval represents a (possibly infinite) range of integers, in the format:

lower-bound .. upper-bound

where *lower-bound* and *upper-bound* are literal integer values, specifying the closed (inclusive) range of integers from the lower bound to the upper bound. In addition, the star character (*) may be used for the upper bound, denoting an unlimited upper bound. In a parameterized context (such as a template), the bounds could be expressions but they must evaluate to literal integer values for any actual use. Unbound expressions that do not evaluate to literal integer values are not permitted.

If a single integer value is specified, then the integer range contains the single integer value.

If the multiplicity specification comprises a single star (*), then it denotes the unlimited nonnegative integer range, that is, it is equivalent to 0..* (zero or more).

A multiplicity of 0..0 is meaningless as it would indicate that no instances can occur.

Expressions in some specification language can be used for multiplicities, but they must resolve to fixed integer ranges within the model (i.e., no dynamic evaluation of expressions, essentially the same rule on literal values as most programming languages).

3.43.3 Style Guidelines

Preferably, intervals should be monotonically increasing. For example, “1..3,7,10” is preferable to “7,10,1..3”.

Two contiguous intervals should be combined into a single interval. For example, “0..1” is preferable to “0,1”.

3.43.4 Example

0..1
1
0..*
*
1..*
1..6
1..3,7..10,15,19..*

3 UML Notation

3.43.5 Mapping

A multiplicity string maps into a Multiplicity value with one or more MultiplicityRanges. Duplications or other nonstandard presentation of the string itself have no effect on the mapping. Note that Multiplicity is a value and not an object. It cannot stand on its own, but is the value of some element property.

3.44 Qualifier

3.44.1 Semantics

A qualifier is an attribute or list of attributes whose values serve to partition the set of instances associated with an instance across an association. The qualifiers are attributes of the association.

3.44.2 Notation

A qualifier is shown as a small rectangle attached to the end of an association path between the final path segment and the symbol of the classifier that it connects to. The qualifier rectangle is part of the association path, not part of the classifier. The qualifier rectangle drags with the path segments. The qualifier is attached to the source end of the association. An instance of the source classifier, together with a value of the qualifier, uniquely select a partition in the set of target classifier instances on the other end of the association (i.e., every target falls into exactly one partition).

The multiplicity attached to the target end denotes the possible cardinalities of the set of target instances selected by the pairing of a source instance and a qualifier value. Common values include:

- “0..1” (a unique value may be selected, but every possible qualifier value does not necessarily select a value).
- “1” (every possible qualifier value selects a unique target instance; therefore, the domain of qualifier values must be finite).
- “*” (the qualifier value is an index that partitions the target instances into subsets).

The qualifier attributes are drawn within the qualifier box. There may be one or more attributes shown one to a line. Qualifier attributes have the same notation as classifier attributes, except that initial value expressions are not meaningful.

It is permissible (although somewhat rare), to have a qualifier on each end of a single association.

3.44.3 Presentation Options

A qualifier may not be suppressed (it provides essential detail whose omission would modify the inherent character of the relationship).

A tool may use a lighter line for qualifier rectangles than for class rectangles to distinguish them clearly.

3.44.4 Style Guidelines

The qualifier rectangle should be smaller than the attached class rectangle, although this is not always practical.

3.44.5 Example

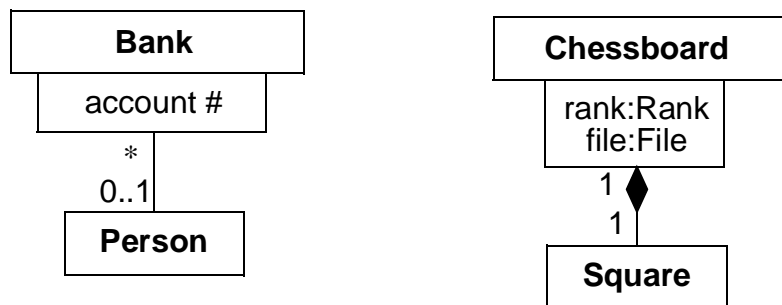

Figure 3-33 Qualified Associations

3.44.6 Mapping

The presence of a qualifier box on an end of an association path maps into a list of qualifier attributes on the corresponding Association Role. Each attribute entry string inside the qualifier box maps into an Attribute.

3.45 Association Class

3.45.1 Semantics

An association class is an association that also has class properties (or a class that has association properties). Even though it is drawn as an association and a class, it is really just a single model element.

3.45.2 Notation

An association class is shown as a class symbol (rectangle) attached by a dashed line to an association path. The name in the class symbol and the name string attached to the association path are redundant and should be the same. The association path may have the usual adornments on either end. The class symbol may have the usual contents. There are no adornments on the dashed line.

3 UML Notation

3.45.3 Presentation Options

The class symbol may be suppressed. It provides subordinate detail whose omission does not change the overall relationship. The association path may not be suppressed.

3.45.4 Style Guidelines

The attachment point should not be near enough to either end of the path that it appears to be attached to, the end of the path, or to any of the association end adornments.

Note that the association path and the association class are a single model element and have a single name. The name can be shown on the path, the class symbol, or both. If an association class has only attributes, but no operations or other associations, then the name may be displayed on the association path and omitted from the association class symbol to emphasize its “association nature.” If it has operations and other associations, then the name may be omitted from the path and placed in the class rectangle to emphasize its “class nature.” In neither case are the actual semantics different.

3.45.5 Example

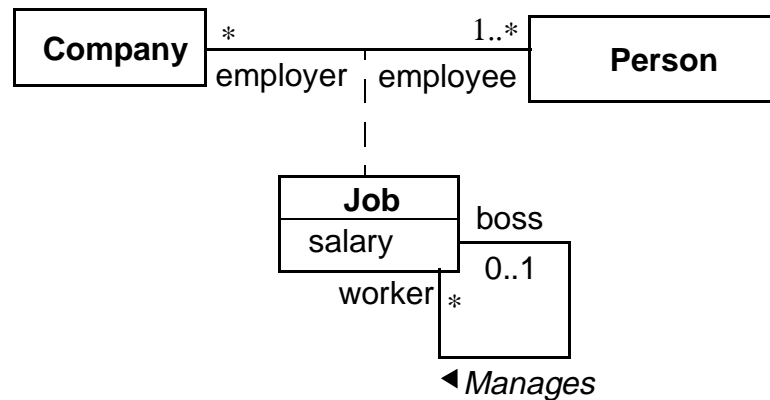

Figure 3-34 Association Class

3.45.6 Mapping

An association path connecting two class boxes connected by a dashed line to another class box maps into a single AssociationClass element. The name of the AssociationClass element is taken from the association path, the attached class box, or both (they must be consistent if both are present). The Association properties map from the association path, as specified previously. The Class properties map from the class box, as specified previously. Any constraints or properties placed on either the association path or attached class box apply to the AssociationClass itself; they must not conflict.

3.46 *N-ary Association*

3.46.1 *Semantics*

An n-ary association is an association among three or more classifiers (a single classifier may appear more than once). Each instance of the association is an n-tuple of values from the respective classifier. A binary association is a special case with its own notation.

Multiplicity for n-ary associations may be specified, but is less obvious than binary multiplicity. The multiplicity on a role represents the potential number of instance tuples in the association when the other N-1 values are fixed.

An n-ary association may not contain the aggregation marker on any role.

3.46.2 *Notation*

An n-ary association is shown as a large diamond (that is, large compared to a terminator on a path) with a path from the diamond to each participant class. The name of the association (if any) is shown near the diamond. Role adornments may appear on each path as with a binary association. Multiplicity may be indicated; however, qualifiers and aggregation are not permitted.

An association class symbol may be attached to the diamond by a dashed line. This indicates an n-ary association that has attributes, operations, and/or associations.

3.46.3 *Style Guidelines*

Usually the lines are drawn from the points on the diamond or the midpoint of a side.

3 UML Notation

3.46.4 Example

This example shows the record of a team in each season with a particular goalkeeper. It is assumed that the goalkeeper might be traded during the season and can appear with different teams.

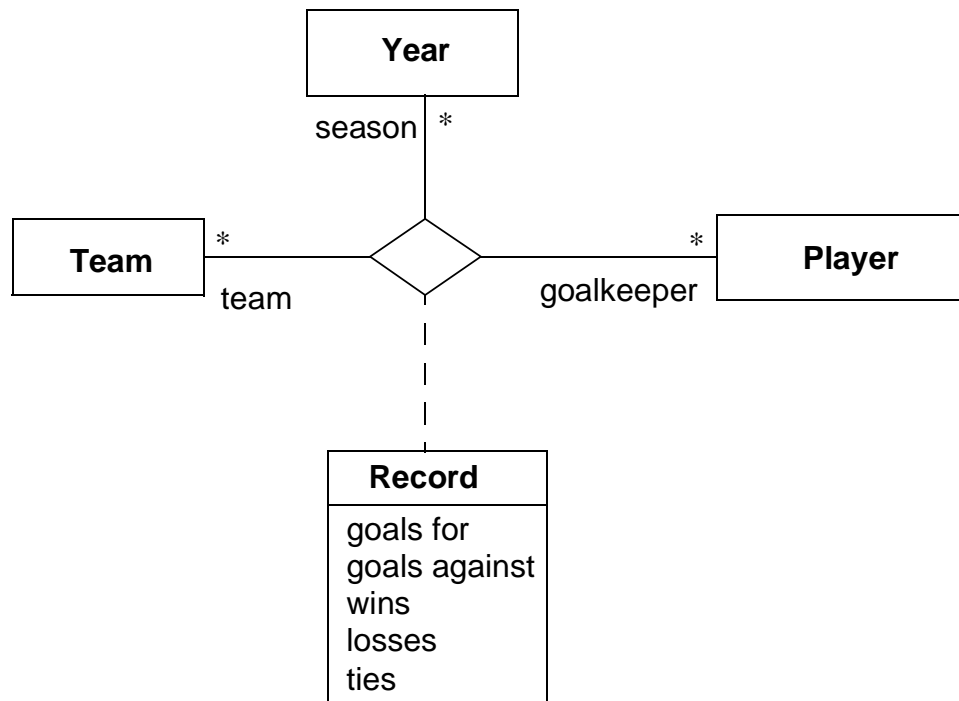

Figure 3-35 Ternary association that is also an association class

3.46.5 Mapping

A diamond attached to some number of class symbols by solid lines maps into an N-ary Association whose AssociationEnds are attached to the corresponding Classes. The ordering of the Classifiers in the Association is indeterminate from the diagram. If a class box is attached to the diamond by a dashed line, then the corresponding Classifier supplies the classifier properties for an N-ary AssociationClass.

3.47 Composition

3.47.1 Semantics

Composition is a form of aggregation with strong ownership and coincident lifetime of part with the whole. The multiplicity of the aggregate end may not exceed one (it is unshared). See “AssociationEnd” on page 2-21 in the Semantics chapter for further details.

The parts of a composition may include classes and associations (they may be formed into AssociationClasses if necessary). The meaning of an association in a composition is that any tuple of objects connected by a single link must all belong to the *same* container object.

3.47.2 Notation

Composition may be shown by a solid filled diamond as an association end adornment. Alternately, UML provides a graphically-nested form that is more convenient for showing composition in many cases.

Instead of using binary association paths using the composition aggregation adornment, composition may be shown by graphical nesting of the symbols of the elements for the parts within the symbol of the element for the whole. A nested class-like element may have a multiplicity within its composite element. The multiplicity is shown in the upper right corner of the symbol for the part. If the multiplicity mark is omitted, then the default multiplicity is many. This represents its multiplicity as a part within the composite classifier. A nested element may have a rolename within the composition; the name is shown in front of its type in the syntax:

rolename ‘:’ classname

This represents its rolename within its composition association to the composite.

Alternately, composition is shown by a solid-filled diamond adornment on the end of an association path attached to the element for the whole. The multiplicity may be shown in the normal way.

Note that attributes are, in effect, composition relationships between a classifier and the classifiers of its attributes.

An association drawn entirely within a border of the composite is considered to be part of the composition. Any instances on a single link of it must be from the same composite. An association drawn such that its path breaks the border of the composite is not considered to be part of the composition. Any instances on a single link of it may be from the same or different composites.

Note that the notation for composition resembles the notation for collaboration. A composition may be thought of as a collaboration in which all of the participants are parts of a single composite object.

Note that nested notation is not the correct way to show a class declared within another class. Such a declared class is not a structural part of the enclosing class but merely has scope within the namespace of the enclosing class, which acts like a package toward the inner class. Such a namespace containment may be shown by placing a package symbol in the upper right corner of the class symbol. A tool can allow a user to click on the package symbol to open the set of elements declared within it.

3 UML Notation

3.47.3 Design Guidelines

Note that a class symbol is a composition of its attributes and operations. The class symbol may be thought of as an example of the composition nesting notation (with some special layout properties). However, attribute notation subordinates the attributes strongly within the class; therefore, it should be used when the structure and identity of the attribute objects themselves is unimportant outside the class.

3.47.4 Example

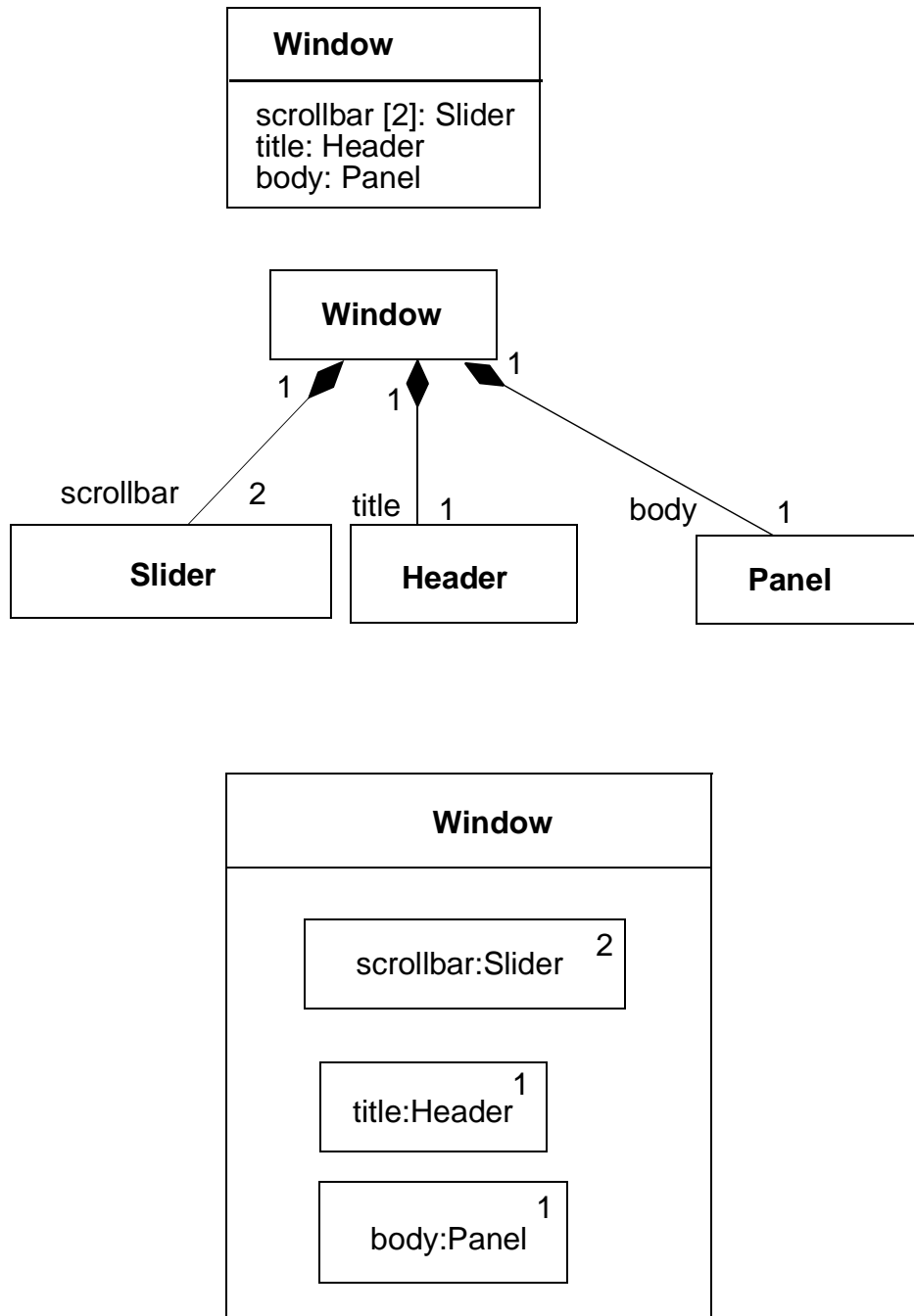

Figure 3-36 Different Ways to Show Composition

3 UML Notation

3.47.5 Mapping

A class box with an attribute compartment maps into a Class with Attributes. Although attributes may be semantically equivalent to composition on a deep level, the mapped model distinguishes the two forms.

A solid diamond on an association path maps into the aggregation-composition property on the corresponding Association Role.

A class box with contained class boxes maps into a set of composition associations; that is, one composition association between the Class corresponding to the outer class box and each of the Classes corresponding to the enclosed class boxes. The multiplicity of the composite end of each association is 1. The multiplicity of each constituent end is 1 if not specified explicitly; otherwise, it is the value specified in the corner of the class box *or* specified on an association path from the outer class box boundary to an inner class box.

3.48 Link

3.48.1 Semantics

A link is a tuple (list) of object references. Most commonly, it is a pair of object references. It is an instance of an association.

3.48.2 Notation

A binary link is shown as a path between two instances. In the case of a link from an instance to itself, it may involve a loop with a single instance. See “Association” on page 3-61 for details of paths.

A rolename may be shown at each end of the link. An association name may be shown near the path. If present, it is underlined to indicate an instance. Links do not have instance names, they take their identity from the instances that they relate. Multiplicity is *not* shown for links because they are instances. Other association adornments (aggregation, composition, navigation) may be shown on the link ends.

A qualifier may be shown on a link. The value of the qualifier may be shown in its box.

Implementation stereotypes

A stereotype may be attached to the link end to indicate various kinds of implementation. The following stereotypes may be used:

«association»	association (default, unnecessary to specify except for emphasis)
«parameter»	method parameter

«local»	local variable of a method
«global»	global variable
«self»	self link (the ability of an instance to send a message to itself)

N-ary link

An n-ary link is shown as a diamond with a path to each participating instance. The other adornments on the association, and the adornments on the association ends, have the same possibilities as the binary link.

3.48.3 Example

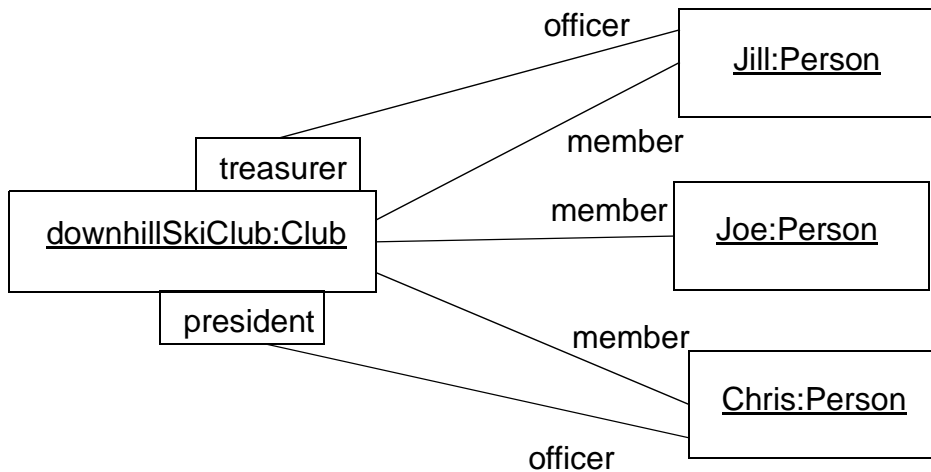

Figure 3-37 Links

3.48.4 Mapping

Within an object diagram, each link path maps to a Link between the Instances corresponding to the connected class boxes. If a name is placed on the link path, then it is an instance of the given Association (and the rolenames must match or the diagram is ill formed).

3.49 Generalization

3.49.1 Semantics

Generalization is the taxonomic relationship between a more general element (the parent) and a more specific element (the child) that is fully consistent with the first element and that adds additional information. It is used for classes, packages, use cases, and other elements.

3 UML Notation

3.49.2 Notation

Generalization is shown as a solid-line path from the child (the more specific element, such as a subclass) to the parent (the more general element, such as a superclass), with a large hollow triangle at the end of the path where it meets the more general element.

A generalization path may have a text label called a discriminator that is the name of a partition of the children of the parent. The child is declared to be in the given partition. The absence of a discriminator label indicates the “empty string” discriminator which is a valid value (the “default” discriminator).

Generalization may be applied to associations as well as classes, although the notation may be messy because of the multiple lines. An association can be shown as an association class for the purpose of attaching generalization arrows.

The existence of additional children in the model that are not shown on a particular diagram may be shown using an ellipsis (. . .) in place of a child.

Note – This does not indicate that additional children may be added in the future. It indicates that additional children exist right now, but are not being seen. This is a notational convention that information has been suppressed, not a semantic statement.

Predefined constraints may be used to indicate semantic constraints among the children. A comma-separated list of keywords is placed in braces either near the shared triangle (if several paths share a single triangle) or near a dotted line that crosses all of the generalization lines involved. The following keywords (among others) may be used (the following constraints are predefined):

overlapping	An element may have two or more children from the set as ancestors. An instance may be a direct or indirect instance of two or more of the children.
disjoint	No element may have two children in the set as ancestors. No instance may be a direct or indirect instance of two of the children.
complete	All children have been specified (whether or not shown). No additional children are expected.
incomplete	Some children have been specified, but the list is known to be incomplete. There are additional children that are not yet in the model. This is a statement about the model itself. Note that this is not the same as the ellipsis, which states that additional children exist in the model but are not shown on the current diagram.

The *discriminator* must be unique among the attributes and association roles of the given parent. Multiple occurrences of the same discriminator name are permitted and indicate that the children belong to the same partition.

The use of multiple classification or dynamic classification affects the dynamic execution semantics of the language, but is not usually apparent from a static model.

3.49.3 Presentation Options

A group of generalization paths for a given parent may be shown as a tree with a shared segment (including the triangle) to the child, branching into multiple paths to each child.

If a text label is placed on a generalization triangle shared by several generalization paths to children, the label applies to all of the paths. In other words, all of the children share the given properties.

3.49.4 Example

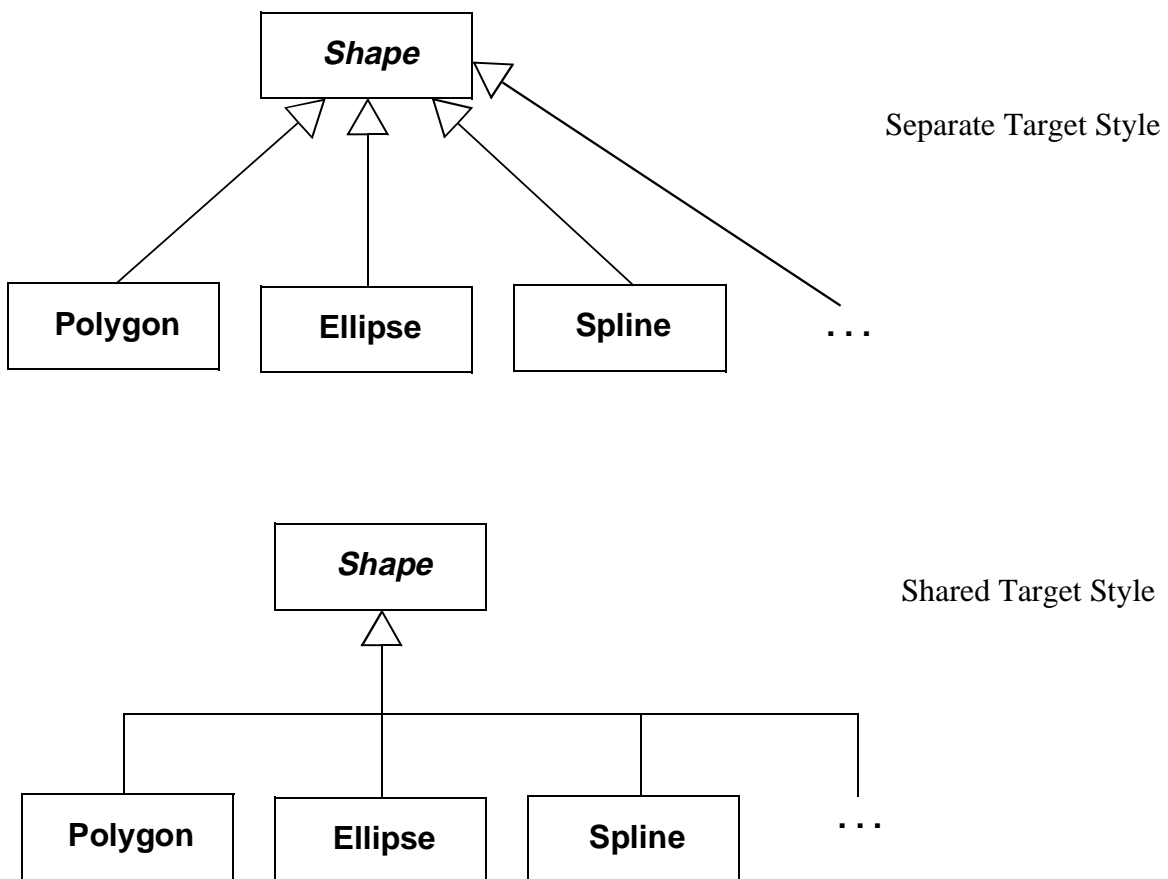

Figure 3-38 Styles of Displaying Generalizations

3 UML Notation

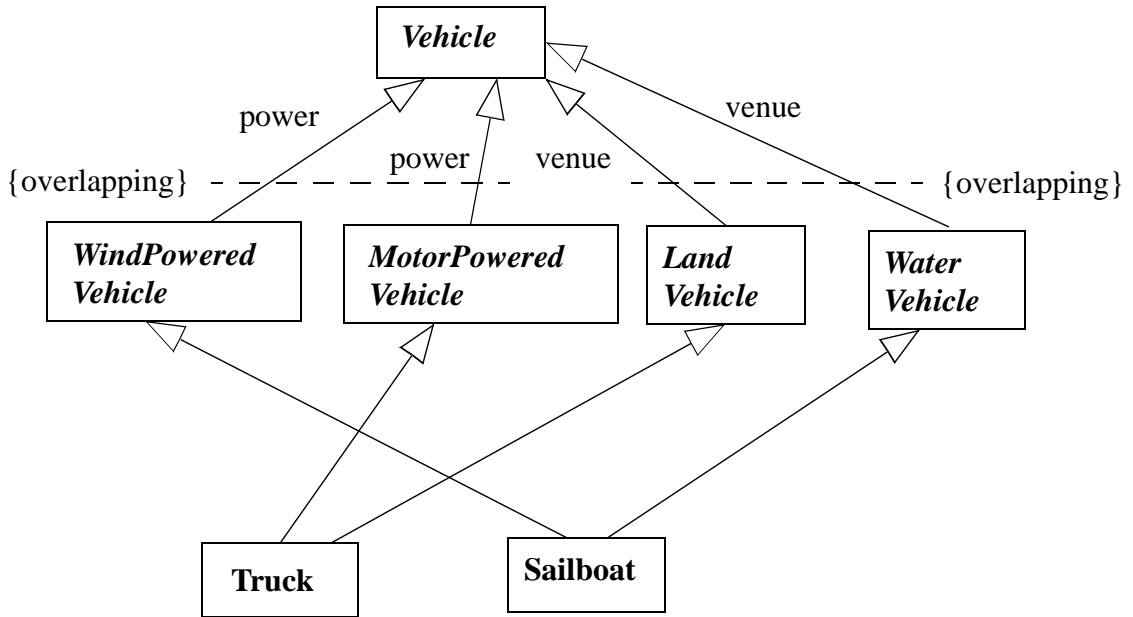

Figure 3-39 Generalization with Discriminators and Constraints, Separate Target Style

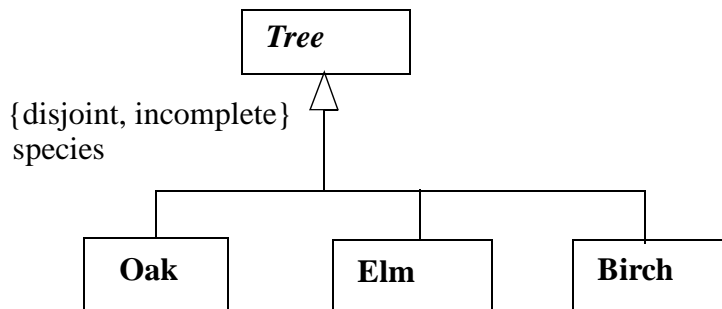

Figure 3-40 Generalization with Shared Target Style

3.49.5 Mapping

Each generalization path between two element symbols maps into a Generalization between the corresponding GeneralizableElements. A generalization tree with one arrowhead and many tails maps into a set of Generalizations, one between each element corresponding to a symbol on a

tail and the single GeneralizableElement corresponding to the symbol on the head. That is, a tree is semantically indistinguishable from a set of distinct arrows, it is purely a notational convenience.

Any property string attached to a generalization arrow applies to the Generalization. A property string attached to the head line segment on a generalization tree represents a (duplicated) property on each of the individual Generalizations.

The presence of an ellipsis (“...”) as a child node of a given parent indicates that the semantic model contains at least one child of the given parent that is not visible on the current diagram. Normally, this indicator will be maintained automatically by an editing tool.

3.50 *Dependency*

3.50.1 *Semantics*

A dependency indicates a semantic relationship between two model elements (or two sets of model elements). It relates the model elements themselves and does not require a set of instances for its meaning. It indicates a situation in which a change to the target element may require a change to the source element in the dependency.

3.50.2 *Notation*

A dependency is shown as a dashed arrow between two model elements. The model element at the tail of the arrow (the client) depends on the model element at the arrowhead (the supplier). The arrow may be labeled with an optional stereotype and an optional individual name.

It is possible to have a set of elements for the client or supplier. In this case, one or more arrows with their tails on the clients are connected the tails of one or more arrows with their heads on the suppliers. A small dot can be placed on the junction if desired. A note on the dependency should be attached at the junction point.

3 UML Notation

The following kinds of Dependency are predefined and may be indicated with keywords. Note that some of these correspond to actual metamodel classes and others to stereotypes of metamodel classes. All of these are shown as dashed arrows with keywords in guillemets. The name column shows the name of the metamodel class or the informal name of the class with the given keyword stereotype.

Keyword	Name	Description
access	Access	The granting of permission for one package to reference the public elements owned by another package (subject to appropriate visibility). Maps into a Permission with the stereotype access.
bind	Binding	A binding of template parameters to actual values to create a nonparameterized element. See Section 3.30, “Bound Element,” on page 3-51 for more details. Maps into a Binding.
derive	Derivation	A computable relationship between one element and another (one more than one of each). Maps into an Abstraction with the stereotype derivation.
import	Import	The granting of permission for one package to reference the public elements of another package, together with adding the names of the public elements of the supplier package to the client package. Maps into a Permission with the stereotype import.
refine	Refinement	A historical or derivation connection between two elements with a mapping (not necessarily complete) between them. A description of the mapping may be attached to the dependency in a note. Various kinds of refinement have been proposed and can be indicated by further stereotyping. Maps into an Abstraction with the stereotype refinement.
trace	Trace	A historical connection between two elements that represent the same concept at different levels of meaning. Maps into an Abstraction with the stereotype trace.
use	Usage	A situation in which one element requires the presence of another element for its correct implementation or functioning. May be stereotyped further to indicate the exact nature of the dependency, such as calling an operation of another class, granting permission for access, instantiating an object of another class, etc. Maps into a Usage. If the keyword is one of the stereotypes of Usage (call, create, instantiate, send) then it maps into a Usage with the given stereotype.

3.50.3 Presentation Options

Note: The connection between a note or constraint and the element it applies to is shown by a dashed line without an arrowhead. This is not a Dependency.

3.50.4 Example

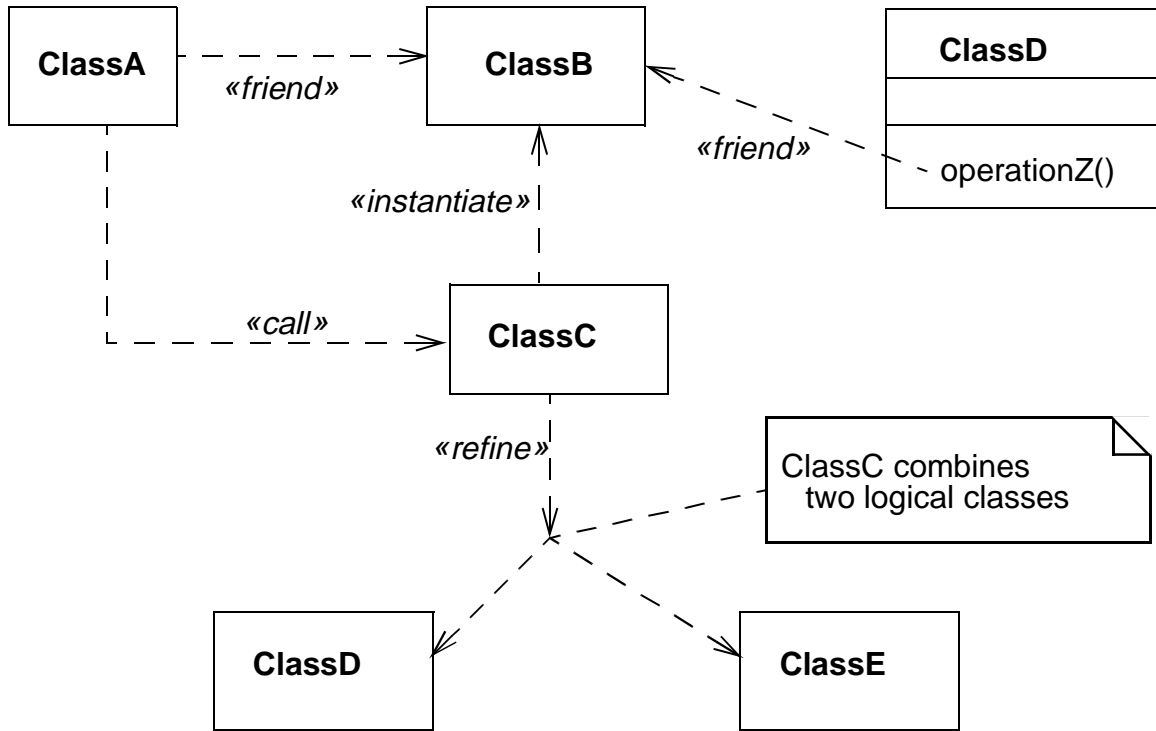

Figure 3-41 Various Dependencies Among Classes

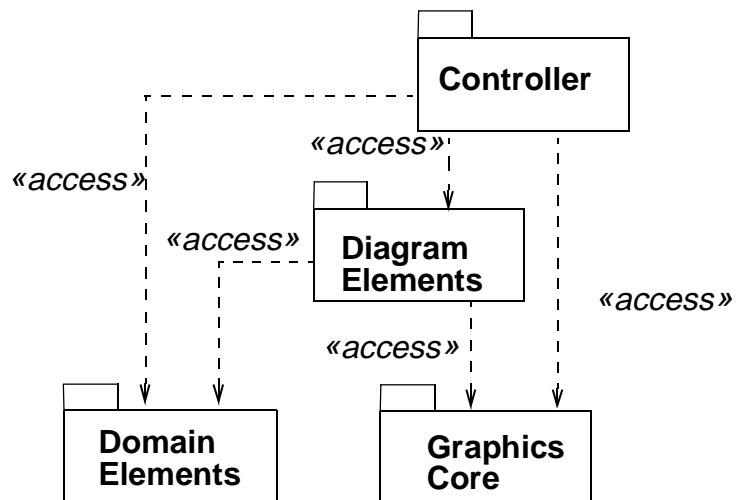

Figure 3-42 Dependencies Among Packages

3 UML Notation

3.50.5 Mapping

A dashed arrow maps into the appropriate kind of Dependency (based on keywords) between the Elements corresponding to the symbols attached to the ends of the arrow. The stereotype and the name (if any) attached to the arrow are the stereotype and name of the Dependency.

3.51 Derived Element

3.51.1 Semantics

A derived element is one that can be computed from another one, but that is shown for clarity or that is included for design purposes even though it adds no semantic information.

3.51.2 Notation

A derived element is shown by placing a slash (/) in front of the name of the derived element, such as an attribute or a rolename.

3.51.3 Style Guidelines

The details of computing a derived element can be specified by a dependency with the stereotype «derive». Usually it is convenient in the notation to suppress the dependency arrow and simply place a constraint string near the derived element, although the arrow can be included when it is helpful.

3.51.4 Example

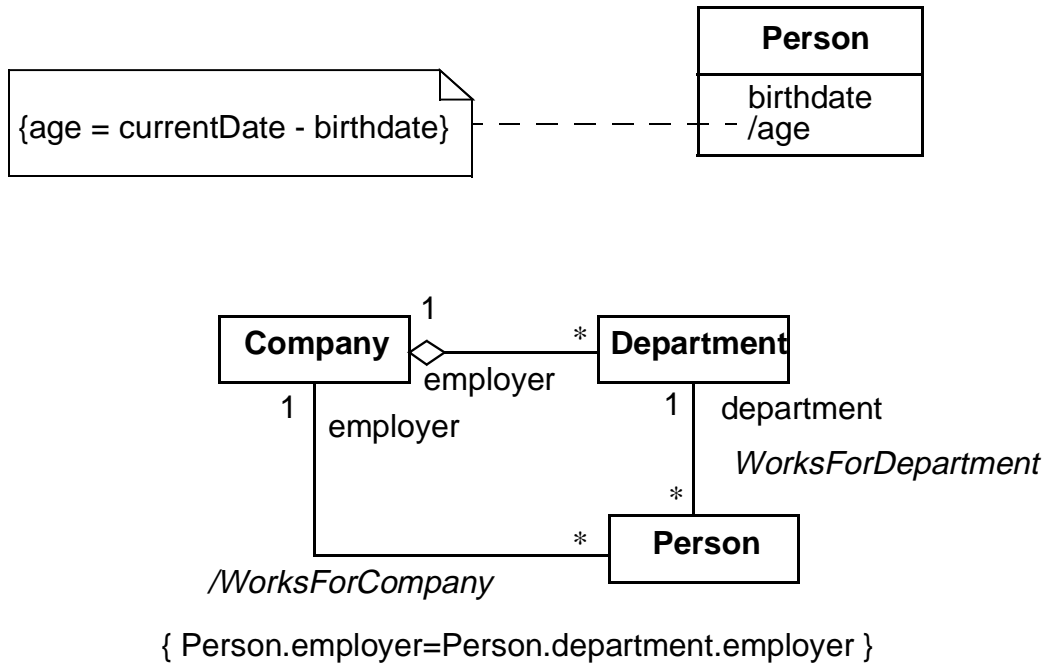

Figure 3-43 Derived Attribute and Derived Association

3.51.5 Mapping

The presence of a derived adornment (a leading “/” on the symbol name) on a symbol maps into the attachment of the “derived” tag to the corresponding Element.

3.52 InstanceOf

3.52.1 Semantics

Shows the connection between an instance and its classifier.

3.52.2 Notation

Shown as a dashed arrow with its tail on the instance and its head on the classifier. The arrow has the keyword «instanceOf».

3.52.3 Mapping

Maps into an instance relationship from the instance to the classifier.

3 UML Notation

Part 6 - Use Case Diagrams

A use case diagram shows the relationship among actors and use cases within a system.

3.53 Use Case Diagram

3.53.1 Semantics

Use case diagrams show actors and use cases together with their relationships. The use cases represent functionality of a system or a classifier, like a subsystem or a class, as manifested to external interactors with the system or the classifier.

3.53.2 Notation

A use case diagram is a graph of actors, a set of use cases, possibly some interfaces, and the relationships between these elements. The relationships are associations between the actors and the use cases, generalizations between the actors, and generalizations, extends, and includes among the use cases. The use cases may optionally be enclosed by a rectangle that represents the boundary of the containing system or classifier.

3 UML Notation

3.53.3 Example

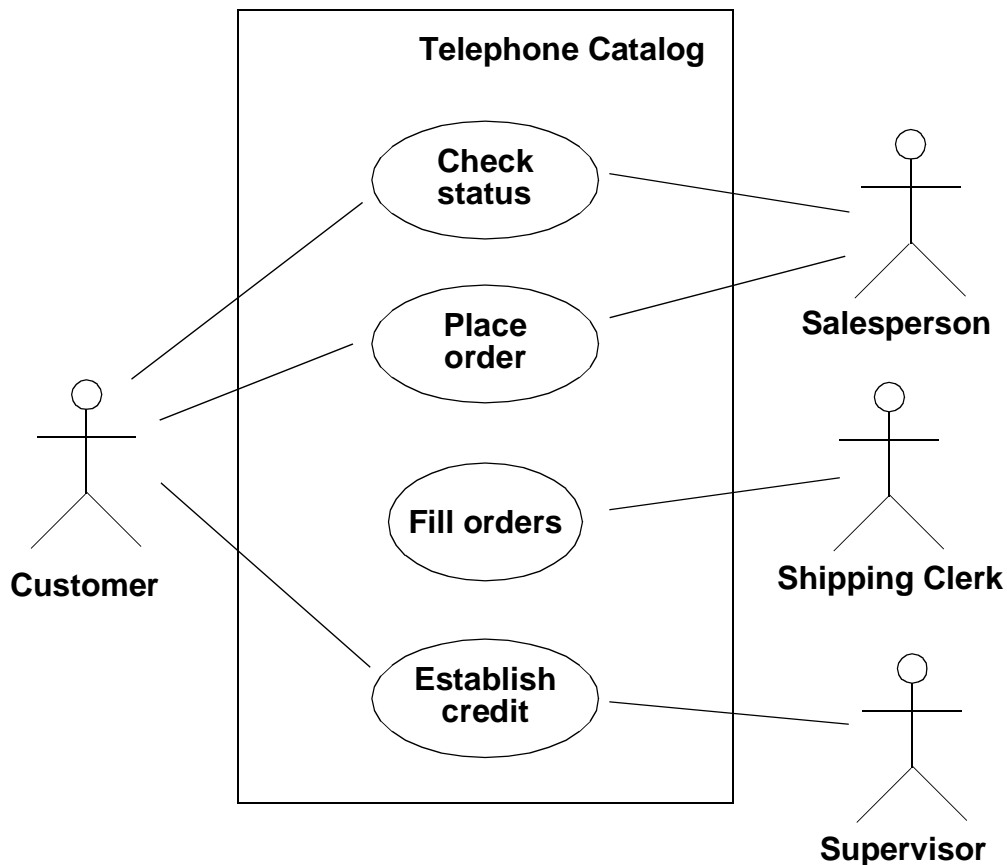

Figure 3-44 Use Case Diagram

3.53.4 Mapping

A set of use case ellipses, possibly within a rectangle, with connections to actor symbols maps to a set of UseCases and Actors corresponding to the use case and actor symbols, respectively. The rectangle maps onto either a Model with the stereotype «useCaseModel» containing the set of UseCases and Actors, or to a Classifier, like Subsystem or Class, containing the set of UseCases. An interface in the diagram is mapped onto an Interface in the Model, and the connection between the interface and the actor or use case icons is mapped onto a realization Dependency (an Abstraction dependency being stereotyped «realize») between the Classifiers. Each generalization arrow maps onto a Generalization in the model, and each line between an actor symbol and a use case ellipse maps to an Association between the corresponding Classifiers. A dashed arrow with the keyword «include» or «extend» maps to an Include or Extend relationship.

3.54 Use Case

3.54.1 Semantics

A *use case* is a kind of classifier representing a coherent unit of functionality provided by a system, a subsystem, or a class as manifested by sequences of messages exchanged among the system and one or more outside interactors (called *actors*) together with actions performed by the system.

An *extension point* is a reference to one location within a use case at which action sequences from other use cases may be inserted. Each extension point has a unique name within a use case, and a description of the location within the behavior of the use case.

3.54.2 Notation

A use case is shown as an ellipse containing the name of the use case. An optional stereotype keyword may be placed above the name and a list of properties included below the name. As a classifier, a use case may also have compartments displaying attributes and operations.

Extension points may be listed in a compartment of the use case with the heading **extension points**. The description of the locations of the extension point is given in a suitable form, usually as ordinary text, but can also be given in other forms, like the name of a state in a state machine, or a precondition or a postcondition.

The behavior of a use case can be described in several different ways, depending on what is convenient: often plain text is used, but state machines, and operations and methods are examples of other ways of describing the behavior of the use case.

3.54.3 Presentation Options

The name of the use case may be placed below the ellipse. The name of an abstract use case may be shown in italics.

The ellipse may contain or suppress compartments presenting the attributes, the operations, and the extension points of the use case.

3.54.4 Style Guidelines

Use case names should follow capitalization and punctuation guidelines used for Classifiers in the model.

3.54.5 Mapping

A use case symbol maps to a UseCase with the given name. An extension point maps into an ExtensionPoint within the UseCase.

3 UML Notation

3.55 Actor

3.55.1 Semantics

An actor defines a coherent set of roles that users of an entity can play when interacting with the entity. An actor may be considered to play a separate role with regard to each use case with which it communicates.

3.55.2 Notation

The standard stereotype icon for an actor is a “stick man” figure with the name of the actor below the figure. An actor may also be shown as a class rectangle with the keyword «actor», with the usual notation for all compartments.

3.55.3 Style Guidelines

Actor names should follow capitalization and punctuation guidelines used for types and classes in the model.

3.55.4 Mapping

An actor symbol maps to an Actor with the given name. The names of abstract actors may be shown in italics

3.56 Use Case Relationships

3.56.1 Semantics

There are several standard relationships among use cases or between actors and use cases.

- Association – The participation of an actor in a use case, i.e. instances of the actor and instances of the use case communicate with each other. This is the only relationship between actors and use cases.
- Extend – An extend relationship from use case A to use case B indicates that an instance of use case B may be augmented (subject to specific conditions specified in the extension) by the behavior specified by A. The behavior is inserted at the location defined by the extension point in B which is referenced by the extend relationship.
- Generalization – A generalization from use case A to use case B indicates that A is a specialization of B.
- Include – An include relationship from use case A to use case B indicates that an instance of the use case A will also contain the behavior as specified by B. The behavior is included at the location which defined in A.

3.56.2 Notation

An association between an actor and a use case is shown as a solid line between the actor and the use case. It may have end adornments such as multiplicity.

An extend relationship between use cases is shown by a dashed arrow with an open arrow-head from the use case providing the extension to the base use case. The arrow is labeled with the keyword «extend». The condition of the relationship is optionally presented close to the keyword.

An include relationship between use cases is shown by a dashed arrow with an open arrow-head from the base use case to the included use case. The arrow is labeled with the keyword «include».

A generalization between use cases is shown by a generalization arrow, i.e. a solid line with a closed, hollow arrow head pointing at the parent use case.

The relationship between a use case and its external interaction sequences is usually defined by an invisible hyperlink to sequence diagrams. The relationship between a use case and its implementation may be shown as refinement relationships to collaborations, but may also be defined as invisible hyperlinks.

3.56.3 Example

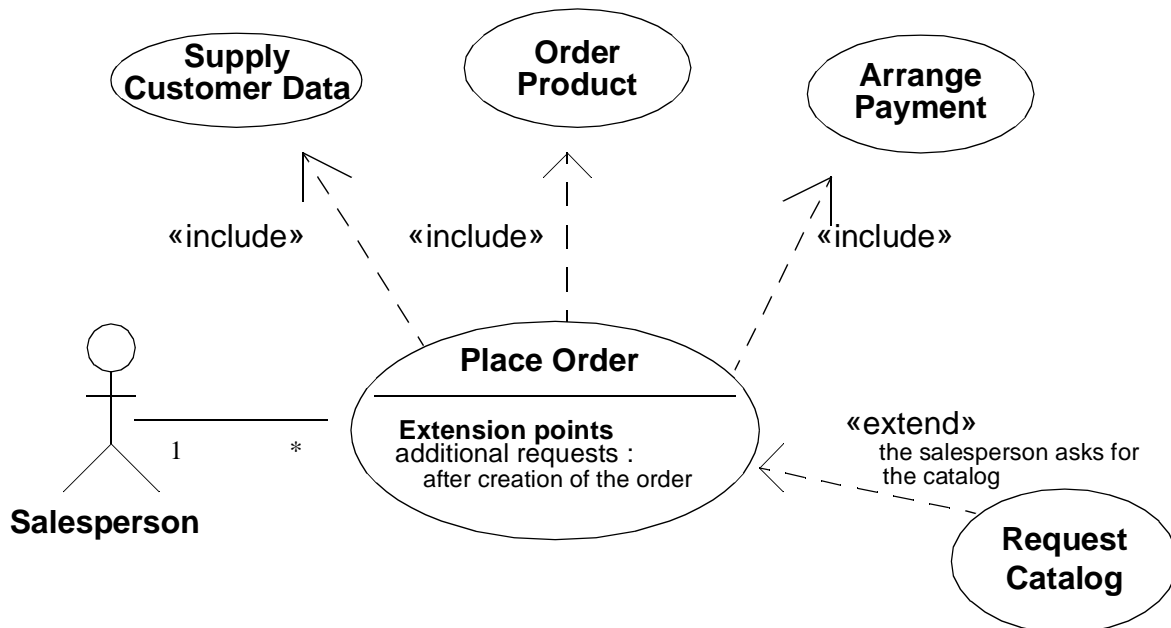

Figure 3-45 Use Case Relationships

3 UML Notation

3.56.4 Mapping

A path between use case and/or actor symbols maps into the corresponding relationship between the corresponding Elements, as described above.

3.57 Actor Relationships

3.57.1 Semantics

There is one standard relationship among actors and one between actors and use cases.

- Association – The participation of an actor in a use case, i.e. instances of the actor and instances of the use case communicate with each other. This is the only relationship between actors and use cases.
- Generalization – A generalization from an actor A to an actor B indicates that an instance of A can communicate with the same kinds of use-case instances as an instance of B.

3.57.2 Notation

An association between an actor and a use case is shown as a solid line between the actor and the use case.

An generalization between actors is shown by a generalization arrow, i.e. a solid line with a closed, hollow arrow head. The arrow head points at the more general actor.

3.57.3 Example

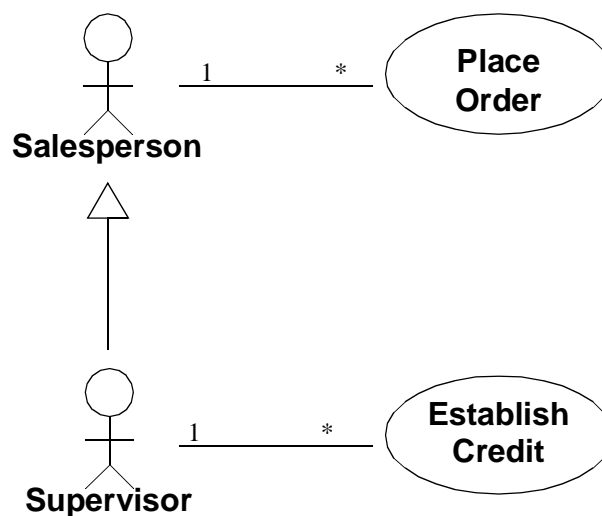

Figure 3-46 Actor Relationships

3.57.4 Mapping

A generalization between two actor symbols and an association between actor symbol and a use case symbol maps into the corresponding relationship between the corresponding Elements, as described above.

3 UML Notation

Part 7 - Sequence Diagrams

3.58 Kinds of Interaction Diagrams

A pattern of interaction among instances is shown on an interaction diagram. Interaction diagrams come in two forms based on the same underlying information, specified by an interaction, but each form emphasizing a particular aspect of it. The two forms are: *sequence diagrams* and *collaboration diagrams*. Sequence diagrams show the explicit sequence of stimuli and are better for real-time specifications and for complex scenarios. Collaboration diagrams show the relationships among instances and are better for understanding all of the effects on a given instance and for procedural design. Collaboration diagrams are described in detail in “Part 8 - Collaboration Diagrams”. That part should be read together with this one, as they have much in common.

A *sequence diagram* shows an interaction arranged in time sequence. In particular, it shows the instances participating in the interaction by their “lifelines” and the stimuli they exchange arranged in time sequence. It does not show the associations among the objects.

A sequence diagram presents a Collaboration with a superposed Interaction. A Collaboration defines a set of participants and relationships that are meaningful for a given set of purposes. The identification of participants and their relationships does not have global meaning. These participants define roles that Instances play when interacting with each other. Hence, a Collaboration specifies a set of ClassifierRoles and AssociationRoles. Instances conforming (or binding) to the ClassifierRoles play the roles defined by the ClassifierRoles, while Links between the Instances will conform to AssociationRoles of the Collaboration. A ClassifierRole (AssociationRole) defines a usage of an Instance (Link), while the Classifier (Association) specifies all properties of the Instance (Link) (see also Section 3.64, “Collaboration,” on page -109).

An Interaction is defined in the context of a Collaboration. It specifies the communication patterns between the roles. More precisely, it contains a set of partially ordered Messages, each specifying one communication, e.g. what Signal to be sent or what Operation to be invoked, as well as the roles to be played by the sender and the receiver, respectively.

Sequence diagrams come in several slightly different formats intended for different purposes, like focusing on execution control, concurrency etc. A sequence diagram can exist in a generic form (describes all the possible sequences) and in an instance form (describes one actual sequence consistent with the generic form). In cases without loops or branches, the two forms are isomorphic.

In the following the term *object* is used, but any kind of instance can be used instead.

3 UML Notation

3.59 Sequence Diagram

3.59.1 Semantics

A sequence diagram presents an Interaction, which is a set of Messages between ClassifierRoles within a Collaboration to effect a desired operation or result.

3.59.2 Notation

A sequence diagram has two dimensions: 1) the vertical dimension represents time and 2) the horizontal dimension represents different objects. Normally time proceeds down the page. (The dimensions may be reversed, if desired.) Usually only time sequences are important, but in real-time applications the time axis could be an actual metric. There is no significance to the horizontal ordering of the objects. Objects can be grouped into “swimlanes” on a diagram. (See subsequent sections for details of the contents of a sequence diagram.)

The different kinds of arrows used in sequence diagrams are described in “Message and Stimulus” on page 3-105, below. These are the same kinds as in collaboration diagrams; see Section 3.72.

Note that much of this notation is drawn directly from the Object Message Sequence Chart notation of Buschmann, Meunier, Rohnert, Sommerlad, and Stal, which is itself derived with modifications from the Message Sequence Chart notation.

3.59.3 Presentation Options

The horizontal ordering of the lifelines is arbitrary. Often call arrows are arranged to proceed in one direction across the page; however, this is not always possible and the ordering does not convey information.

The axes can be interchanged, so that time proceeds horizontally to the right and different objects are shown as horizontal lines.

Various labels (such as timing constraints, descriptions of actions during an activation, and so on) can be shown either in the margin or near the transitions or activations that they label.

Timing constraints may be expressed using time expressions on message names. The functions *sendTime* (the time at which a message is sent by an object) and *receiveTime* (the time at which a message is received by an object) may be applied to message names to yield a time. The set of time functions is open-ended, so that users can invent new ones as needed for special situations or implementation distinctions (such as *elapsedTime*, *executionStartTime*, *queuedTime*, *handledTime*, etc.)

Construction marks of the kind found in blueprints can be used to indicate a time interval to which a constraint may be attached (see bottom right of Figure 3-47 on page 99). This notation is visually appealing but it is ambiguous if the message line is horizontal, because the send time and the receive time cannot be distinguished. In many cases the transmission time is negligible, so the ambiguity is harmless, but a tool must nevertheless map such a notation unambiguously to an expression on message names (as shown in the examples in the left of the diagram) before the information is placed in the semantic model. (A tool may adopt defaults for this mapping.)

3.59 Sequence Diagram

Similarly, a tool might permit the time function to be elided and use the message name to denote the time of message sending or receipt within a timing expression (such as “b.receiveTime - a.sendTime < 1 sec.” in Figure 3-47), but again this is only a surface notation that must be mapped to a proper time expression in the semantic model).

3.59.4 Example

Simple sequence diagram with concurrent objects.

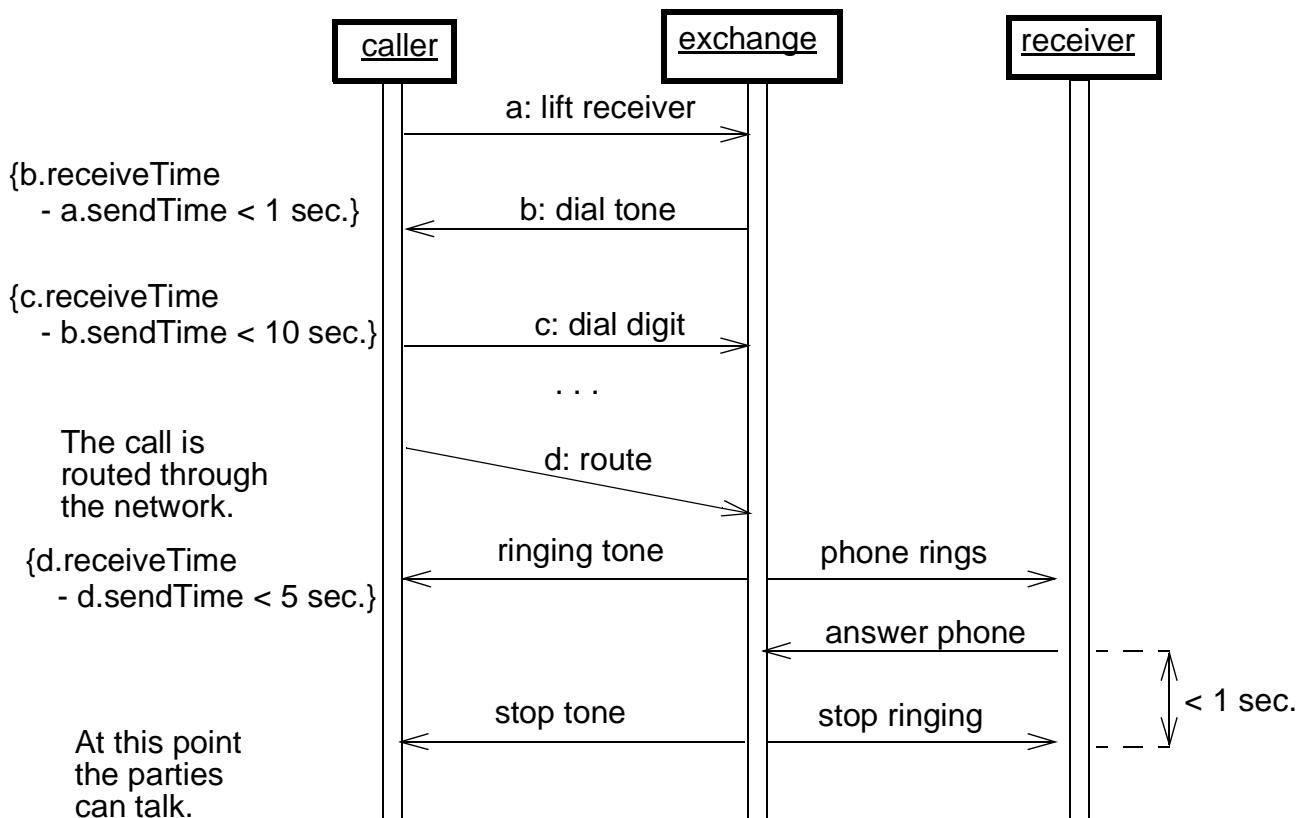

Figure 3-47 Simple Sequence Diagram with Concurrent Objects (denoted by boxes with thick borders).

3 UML Notation

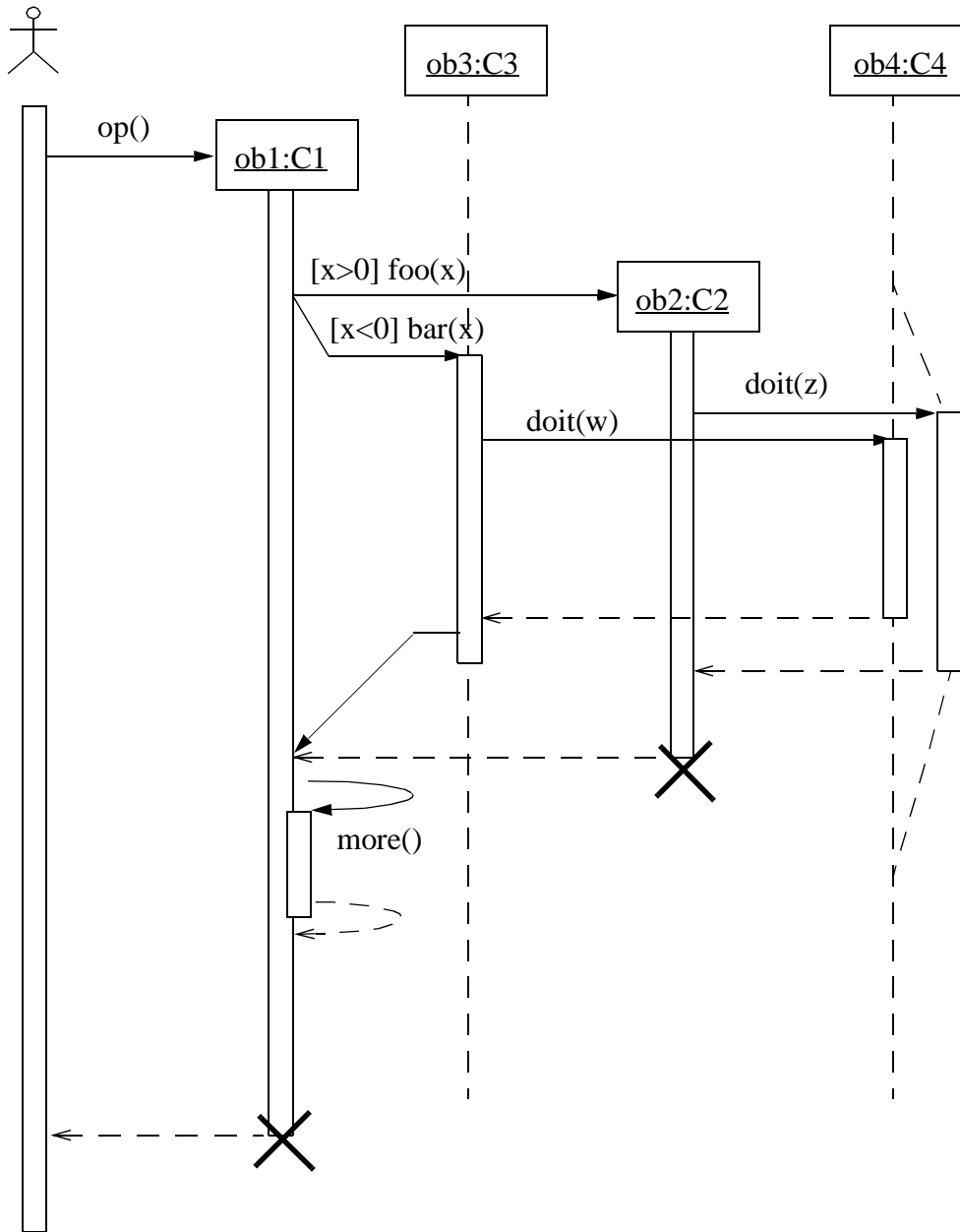

Figure 3-48 Sequence Diagram with Focus of Control, Conditional, Recursion, Creation, and Destruction.

3.59.5 Mapping

This section summarizes the mapping for the sequence diagram and the elements within it, some of which are described in subsequent sections.

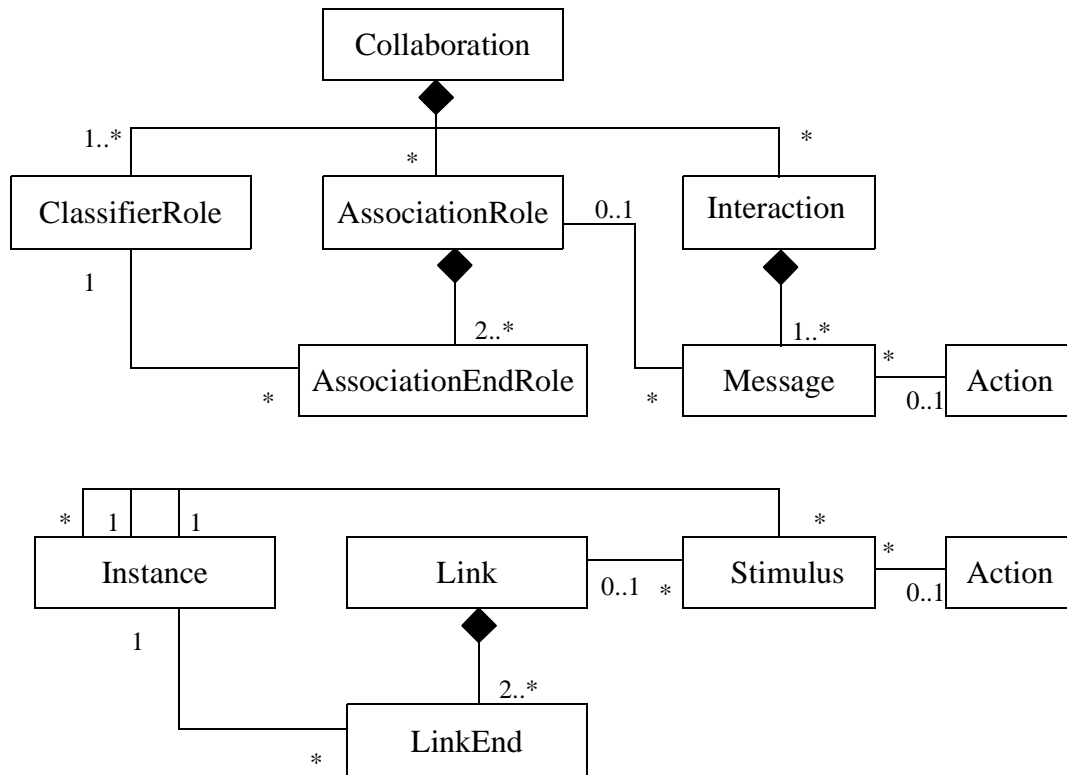

Figure 3-49 A summary of the UML constructs used in the section below.

Sequence diagram

A sequence diagram maps into an Interaction and an underlying Collaboration. An Interaction specifies a sequence of communications; it contains a collection of partially ordered Messages, each specifying a communication between a sender role and a receiver role. Collections of Objects that conform to the ClassifierRoles in the Collaboration owning the Interaction, communicate by dispatching Stimuli that conform to the Messages in the Interaction. A sequence diagram presents one collection of object symbols and arrows mapping to Objects and Stimuli that conform to the ClassifierRoles and Messages in the Interaction and its Collaboration.

In an sequence diagram, each object box with its lifeline maps into an Object which conforms to a ClassifierRole in the Collaboration. The name field maps into the name of the Object, the role name into the ClassifierRole's name, and the class field maps into the names of the Classifiers (in this case Classes) being the *base* Classifiers of the ClassifierRole. The associations among roles are not shown on the sequence diagram. They must be obtained in the model from a complementary collaboration diagram or other means. A message arrow maps

3 UML Notation

into a Stimulus connected to two Objects: the sender and the receiver. The Stimulus conforms to a Message between the ClassifierRoles corresponding to the two Objects' lifelines that the arrow connects. The Link used for the communication of the Stimulus plays the role specified by the AssociationRole connected to the Message. Unless the correct Link can be determined from a complementary collaboration diagram or other means, the Stimulus is either not attached to a Link (not a complete model), or it is attached to an arbitrary Link or to a dummy Link between the Instances conforming to the AssociationRole implied by the two ClassifierRoles due to the lack of complete information. The name of the Operation to be invoked or Signal to be sent is mapped onto the name of the Operation or Signal associated by the Action connected to the Message. Different alternatives exist for showing the arguments of the Stimulus. If references to the actual Instances being passed as arguments are shown, these are mapped onto the arguments of the Stimulus. If the argument expressions are shown instead, these are mapped onto the Arguments of the Action connected to the dispatching Action. Finally, if the types of the arguments are shown together with the name of the Operation or the Signal, these are mapped onto the parameter types of the Operation or the Attribute types of the Signal, respectively. A timing label placed on the level of an arrow endpoint maps into the name of the corresponding Message. A constraint placed on the diagram maps into a Constraint on the entire Interaction.

An arrow with the arrowhead pointing to an object symbol within the frame of the diagram maps into a Stimulus dispatched by a CreateAction, i.e. the Stimulus conforms to a Message in the Interaction which is connected to the CreateAction. The interpretation is that the Object is created by dispatching the Stimulus, and the Object conforms to the receiver role specified by the Message. After the creation of the Object, it may immediately start interacting with other Objects. This implies that the creation method (constructor, initializer) of the Object dispatches these Stimuli. If an object termination symbol ("X") is the target of an arrow, the arrow maps into a Stimulus which will cause the receiving Object to be removed. The Stimulus conforms to a Message in the Interaction with a DestroyAction attached to the Message. If the object termination symbol appears in the diagram without an incoming arrow, it maps into a TerminateAction.

The order of the arrows in the diagram maps onto a pair of associations between the Messages that correspond to the Stimuli the arrows map onto. A *predecessor* association is established between Messages corresponding to successive arrows in the vertical sequence. In case of concurrent arrows preceding an arrow, the corresponding Message has a collection of predecessors. Moreover, each Message has an *activator* association to the Message corresponding to the incoming arrow of the activation.

Procedural sequence diagram

On a procedural sequence diagram (one with focus of control and calls), subsequent arrows on the same lifeline map into Stimuli obeying the *predecessor* association between their corresponding Messages. An arrow to the head of a focus of control region establishes a nested activation. The arrow maps into a Stimulus conforming to a Message with the dispatching Action being a CallAction. The Stimulus holds the sender and receiver Objects, as well as the argument Objects to be supplied in the invocation and references the target Operation to be invoked. The expressions that evaluate to the arguments of the Operation are the *argument* Expressions on the CallAction connected to the Message, while the sender and receiver roles are specified by the *sender* and *receiver* ClassifierRoles of the Message. The sender and receiver Objects conform to these ClassifierRoles. Any guard conditions or iteration conditions

attached to the arrow become *recurrence* values of the Action attached to the Message. All arrows departing the nested activation map into Messages with an *activation* Association to the Message corresponding to the arrow at the head of the activation. A return arrow departing the end of the activation maps into a Stimulus conforming to a Message with:

- an *activation* Association to the Message corresponding to the arrow at the head of the activation, and
- a *predecessor* association to the previous Message within the same activation, i.e. the last Message being sent in the activation.

A return must be the final Message within a predecessor chain. It is not the predecessor of any Message.

3.60 Object Lifeline

3.60.1 Semantics

In a sequence diagram an object lifeline denotes an Object playing a specific role. Arrows between the lifelines denote communication between the Objects playing those roles. Within a sequence diagram the existence and duration of the Object in a role is shown, but the Relationships among the Objects are not shown. The role is specified by a ClassifierRole; it describes the properties of an Object playing the role and describes the Relationships an Object in that role has to other Objects.

3.60.2 Notation

An Object is shown as a vertical dashed line called the “lifeline.” The lifeline represents the existence of the Object at a particular time. If the Object is created or destroyed during the period of time shown on the diagram, then its lifeline starts or stops at the appropriate point; otherwise, it goes from the top to the bottom of the diagram. An object symbol is drawn at the head of the lifeline. If the Object is created during the diagram, then the arrow, which maps onto the stimulus that creates the object, is drawn with its arrowhead on the object symbol. If the object is destroyed during the diagram, then its destruction is marked by a large “X,” either at the arrow mapping to the Stimulus that causes the destruction or (in the case of self-destruction) at the final return arrow from the destroyed Object. An Object that exists when the transaction starts is shown at the top of the diagram (above the first arrow), while an Object that exists when the transaction finishes has its lifeline continue beyond the final arrow.

The lifeline may split into two or more concurrent lifelines to show conditionality. Each separate track corresponds to a conditional branch in the communication. The lifelines may merge together at some subsequent point.

3.60.3 Example

See Figure 3-48 on page 3-100.

3 UML Notation

3.60.4 Mapping

See “Mapping” on page 3-101.

3.61 Activation

3.61.1 Semantics

An activation (focus of control) shows the period during which an Object is performing an Action either directly or through a subordinate procedure. It represents both the duration of the performance of the Action in time and the control relationship between the activation and its callers (stack frame).

3.61.2 Notation

An activation is shown as a tall thin rectangle whose top is aligned with its initiation time and whose bottom is aligned with its completion time. The Action being performed may be labeled in text next to the activation symbol or in the left margin, depending on style. Alternately, the incoming arrow may indicate the Action, in which case it may be omitted on the activation itself. In procedural flow of control, the top of the activation symbol is at the tip of an incoming arrow (the one that initiates the action) and the base of the symbol is at the tail of a return arrow.

In the case of concurrent Objects each with their own threads of control, an activation shows the duration when each Object is performing an Operation. Operations by other Objects are not relevant. If the distinction between direct computation and indirect computation (by a nested procedure) is unimportant, the entire lifeline may be shown as an activation.

In the case of procedural code, an activation shows the duration during which a procedure is active in the Object or a subordinate procedure is active, possibly in some other Object. In other words, all of the active nested procedure activations may be seen at a given time. In the case of a recursive call to an Object with an existing activation, the second activation symbol is drawn slightly to the right of the first one, so that they appear to “stack up” visually. (Recursive calls may be nested to an arbitrary depth.)

3.61.3 Example

See Figure 3-47 on page 99 and Figure 3-48 on page 3-100.

3.61.4 Mapping

See “Mapping” on page 3-101.

3.62 Message and Stimulus

3.62.1 Semantics

A Stimulus is a communication between two Objects that conveys information with the expectation that action will ensue. A Stimulus will cause an Operation to be invoked, raise a Signal, or cause an Object to be created or destroyed.

A Message is a specification of Stimulus, i.e. it specifies the roles that the sender and the receiver Objects must conform to, as well as the Action which will, when executed, dispatch a Stimulus that conforms to the Message.

3.62.2 Notation

In a sequence diagram a Stimulus is shown as a horizontal solid arrow from the lifeline of one Object to the lifeline of another Object. In case of a Stimulus from an Object to itself, the arrow may start and finish on the same Object lifeline. The arrow is labeled with the name of the Stimulus (Operation or Signal) and its argument values or argument expressions.

The arrow may also be labeled with a sequence number to show the sequence of the Stimulus in the overall interaction. However, sequence numbers are often omitted in sequence diagrams, as the physical location of the arrow shows the relative sequences, but they are necessary in collaboration diagrams. Sequence numbers are useful on both kinds of diagrams for identifying concurrent threads of control. A Stimulus may also be labeled with a guard condition.

3.62.3 Presentation options

The following arrowhead variations may be used to show different kinds of communications:

filled solid arrowhead 

Procedure call or other nested flow of control. The entire nested sequence is completed before the outer level sequence resumes. May be used with ordinary procedure calls. May also be used with concurrently active objects when one of them sends a Signal and waits for a nested sequence of behavior to complete.

stick arrowhead 

Flat flow of control. Each arrow shows the progression to the next step in sequence. Normally all of the messages are asynchronous.

half stick arrowhead 

An asynchronous Stimulus. Used instead of the stick arrowhead to explicitly show an asynchronous communication between two Objects in a procedural sequence.

3 UML Notation

dashed arrow with stick arrowhead - ➔

Return from procedure call.

Variation:

In a procedural flow of control, the return arrow may be omitted (it is implicit at the end of an activation). It is assumed that every call has a paired return after any subordinate stimuli. The return value can be shown on the initial arrow. For nonprocedural flow of control (including parallel processing and asynchronous messages) returns should be shown explicitly.

Variation:

In a concurrent system, a full arrowhead shows the yielding of a thread of control (wait semantics) and a half arrowhead shows the sending of a message without yielding control (no-wait semantics).

Variation:

Normally message arrows are drawn horizontally. This indicates the duration required to send the stimulus is “atomic,” i.e. it is brief compared to the granularity of the interaction and that nothing else can “happen” during the transmission of the stimulus. This is the correct assumption within many computers. If the stimulus requires some time to arrive, during which something else can occur (such as a stimulus in the opposite direction), then the arrow may be slanted downward so that the arrowhead is below the arrow tail.

Variation: Branching

A branch is shown by multiple arrows leaving a single point, each labeled by a guard condition. Depending on whether the guard conditions are mutually exclusive, the construct may represent conditionality or concurrency.

Variation: Iteration

A connected set of arrows may be enclosed and marked as an iteration. For a generic sequence diagram, the iteration indicates that the dispatch of a set of stimuli can occur multiple times. For a procedure, the continuation condition for the iteration may be specified at the bottom of the iteration. If there is concurrency, then some arrows in the diagram may be part of the iteration and others may be single execution. It is desirable to arrange a diagram so that the arrows in the iteration can be enclosed together easily.

Variation:

A lifeline may subsume an entire set of objects on a diagram representing a high-level view.

Variation:

A distinction may be made between a period during which an Object has a live activation and a period in which the activation is actually computing. The former (during which it has control information on a stack but during which control resides in something that it called) is shown with the ordinary double line. The latter (during which it is the top item on the stack) may be distinguished by shading the region.

3.62.4 Mapping

See “Mapping” on page 3-101.

3.63 Transition Times

3.63.1 Semantics

A Message may specify several different times, e.g. a sending time and a receiving time. These are formal names that may be used within Constraint expressions. The set of different kinds of times is open-ended so that users can invent new ones as needed for special situations, such as *elapsedTime* and *startExecutionTime*. These expressions may be used in Constraints to designate specific time constraints valid for the Message.

3.63.2 Notation

A transition instance (such as a Stimulus in a sequence diagram, a collaboration diagram, or a Transition in a state machine) may be given a name. A timing constraint is formed as an expression based on the name of the transition. For example, if the name of a Stimulus is *stim*, its send-time is expressed by *stim.sendTime* (), and its receive-time by *stim.receiveTime* (). The timing constraint may be shown in the left margin aligned with the arrow (on a sequence diagram) or near the tail of the arrow (on a collaboration diagram). Constraints may be specified by placing Boolean expressions, possibly including time expressions, in braces on the sequence diagram.

3.63.3 Presentation Options

When it is clear from the context, the name of a Message or the name of a Stimulus may itself be used to denote the time at which the transition started. In cases where the performance of the transition is not instantaneous, the time at which the transition is ended may be indicated by the same name with a prime sign appended to the name.

3.63.4 Example

See Figure 3-47 on page 3-99.

3 UML Notation

3.63.5 Mapping

See “Mapping” on page 3-101.

Part 8 - Collaboration Diagrams

A pattern of interactions among instances is shown on an interaction diagram. Interaction diagrams come in two forms based on the same underlying information, specified by an interaction, but each form emphasizing a particular aspect of it. The two forms are: *sequence diagrams* and *collaboration diagrams*. A collaboration diagram shows an interaction organized around the roles in the interaction and their links to each other. Unlike a sequence diagram, a collaboration diagram shows the relationships among the objects playing the different roles. On the other hand, a collaboration diagram does not show time as a separate dimension, so the sequence of interactions and the concurrent threads must be determined using sequence numbers. Hence, sequence diagrams show the explicit sequence of stimuli and are better for real-time specifications and for complex scenarios. Sequence diagrams are described in detail in “Part 7 - Sequence Diagrams”. That part should be read together with this one, as they have much in common.

A collaboration diagram can be given in two different forms: either at *specification level* (the diagram shows ClassifierRoles, AssociationRoles, and Messages) or at *instance level* (the diagram shows Objects, Links, and Stimuli). The former presents the roles and their structure as defined in the underlying Collaboration, while the latter focuses on instance that conforms to the roles in the Collaboration.

In the following the term *Object* is used, but any kind of Instance can be used.

3.64 Collaboration

3.64.1 Semantics

Behavior is implemented by sets of Objects that exchange Stimuli within an overall interaction to accomplish a purpose. To understand the mechanisms used in a design, it is important to see only those Objects and their interaction involved in accomplishing a purpose or a related set of purposes, projected from the larger system of which they are part for other purposes. Such a static construct is called a *Collaboration*.

A Collaboration defines a set of participants and relationships that are meaningful for a given set of purposes. The identification of participants and their relationships does not have global meaning. These participants define roles that Objects play when interacting with each other. Hence, a Collaboration specifies a set of ClassifierRoles and AssociationRoles. Objects conforming (or binding) to the ClassifierRoles play the roles defined by the ClassifierRoles, while Links between the Objects will conform to AssociationRoles of the Collaboration. A ClassifierRole (AssociationRole) defines a usage of an Object (Link), while the Class (Association) specifies all properties of the Object (Link).

3 UML Notation

An Interaction is defined in the context of a Collaboration. It specifies the communication patterns between the roles. More precisely, it contains a set of partially ordered Messages, each specifying one communication, e.g. what Signal to be sent or what Operation to be invoked, as well as the roles to be played by the sender and the receiver, respectively.

A Collaboration may be attached to an Operation or a Classifier, like a UseCase, to describe the context in which their behavior occurs, i.e. what roles Objects play to perform the behavior specified by the Operation or the UseCase. The Collaboration is said to be a realization of the Operation or the UseCase. The Interactions defined within the Collaboration specify the communication pattern between the Objects when they perform the behavior specified in the Operation or the UseCase. These patterns are presented in sequence diagrams or collaboration diagrams. A Collaboration may also be attached to a Class to define the static structure of the Class, i.e. how attributes, parameters etc. cooperate with each other.

A parameterized Collaboration represents a design construct that can be used repeatedly in different designs. The participants in the Collaboration, including the Classifiers and Relationships, can be parameters of the generic Collaboration. The parameters are bound to particular ModelElements in each instantiation of generic Collaboration. Such a parameterized Collaboration can capture the structure of a *design pattern* (note that a design pattern involves more than structural aspects). Whereas most Collaborations can be anonymous because they are attached to a named ModelElement, patterns are free standing design constructs that must have names.

A Collaboration may be expressed at different levels of granularity. A coarse-grained Collaboration may be refined to produce another Collaboration that has a finer granularity.

3.64.2 Notation

The description of behavior involves two aspects: 1) the structural description of the participants and 2) the description of the communication patterns. The two aspects are often described together on a single diagram, but at times it is useful to describe the structural and interaction aspects separately. The structure of Objects playing roles in a behavior and their relationships is called a *Collaboration*. A collaboration diagram shows the context in which interaction occurs. The sequences of Stimuli exchanged among Objects to accomplish a specific purpose is called an *Interaction*. A Collaboration is shown by a collaboration diagram which does not include any communication. By adding communication to the diagram, an Interaction is shown superposed on the Collaboration in which the Interaction is defined. Different sets of communication may be applied to the same Collaboration to yield different Interactions. The communication can be shown at two different levels: at *instance level* or at *specification level*. An instance level diagram shows Objects and Links together with Stimuli being exchanged between the Objects, while a specification level diagram shows ClassifierRoles, AssociationRoles, and Messages. The model elements in the instance level diagram conform to the model elements in the specification level diagram (see Section 3.69, “Collaboration Roles,” on page 3-118).

3.64.3 Mapping

A Collaboration Diagram or an Interaction Diagram given at specification level is mapped onto a Collaboration, possibly together with an Interaction, including those elements owned by the Collaboration. If the diagram is given at instance level, it is mapped onto a set of Instances and Links conforming to the Collaboration. The detailed mapping is described in Section 3.69, “Collaboration Roles,” on page 3-118, below.

3.65 Collaboration Diagram

3.65.1 Semantics

A collaboration diagram presents a Collaboration, which contains a set of roles to be played by Objects, as well as their required relationships given in a particular context. The diagram may also present an Interaction, which defines a set of Messages specifying the interaction between the Objects playing the roles within a Collaboration to achieve the desired result.

A Collaboration is used for describing the realization of an Operation or a Classifier. A Collaboration which describes a Classifier, like a UseCase, references Classifiers and Associations in general, while a Collaboration describing an Operation includes the arguments and local variables of the Operation, as well as ordinary Associations attached to the Classifier owning the Operation.

3.65.2 Notation

A collaboration diagram shows a graph of either Objects linked to each other, or ClassifierRoles and AssociationRoles; it may also include the communication stated by an Interaction. A collaboration diagram can be given in two different forms: at *instance level* or at *specification level*; it may either show Instances, Links, and Stimuli, or show ClassifierRoles, AssociationRoles, and Messages (see below).

Because collaboration diagrams often are used to help design procedures, they typically show navigability using arrowheads on the lines representing Links or AssociationRoles. (An arrowhead on a line between boxes indicates a Link or AssociationRole with one-way navigability. An arrow next to a line indicates Stimuli flowing in the given direction. Obviously such an arrow cannot point backwards over a one-way line.)

The order of the interaction is described with a sequence of numbers, usually starting with number *1*. For a procedural flow of control, the subsequent communication numbers are nested in accordance with call nesting. For a nonprocedural sequence of interactions among concurrent objects, all the sequence numbers are at the same level (that is, they are not nested).

A collaboration diagram without any interaction shows the *context* in which interactions can occur. It might be used to show the context for a single Operation or even for all of the Operations of a Class or group of Classes.

3 UML Notation

A collection of standard constraints may be used to show whether an Object or a Link is created or destroyed during the execution:

- Objects and Links created during the execution may be designated as {new}.
- Objects and Links destroyed during the execution may be designated as {destroyed}.
- Objects and Links created during the execution and then destroyed may be designated as {transient}.

These changes in life state are derivable from the detailed interaction among the Objects, they are provided as notational conveniences.

Instance level

A collaboration diagram given at instance level shows a collection of object boxes and lines mapping to Objects and Links, respectively. These instances conform to the ClassifierRoles and AssociationRoles of the Collaboration. The diagram may also include arrows attached to the lines that correspond to Stimuli communicated over the Links. The diagram shows the Objects relevant to the realization of an Operation or Classifier, including Objects indirectly affected or accessed during the performance. The diagram also shows the Links among the Objects, including transient ones representing procedure arguments, local variables, and *self* links. Individual attribute values are usually not shown explicitly. If Stimuli must be sent to attribute values, the Attributes should be modeled using Associations instead.

Specification level

A collaboration diagram given at specification level shows the roles defined within a Collaboration. Together, these roles form a realization of the attached Operation or Classifier of the Collaboration. The diagram contains a collection of class boxes and lines corresponding to ClassifierRoles and AssociationRoles in the Collaboration. In this case the arrows attached to the lines map onto Messages.

3.65 Collaboration Diagram

3.65.3 Example

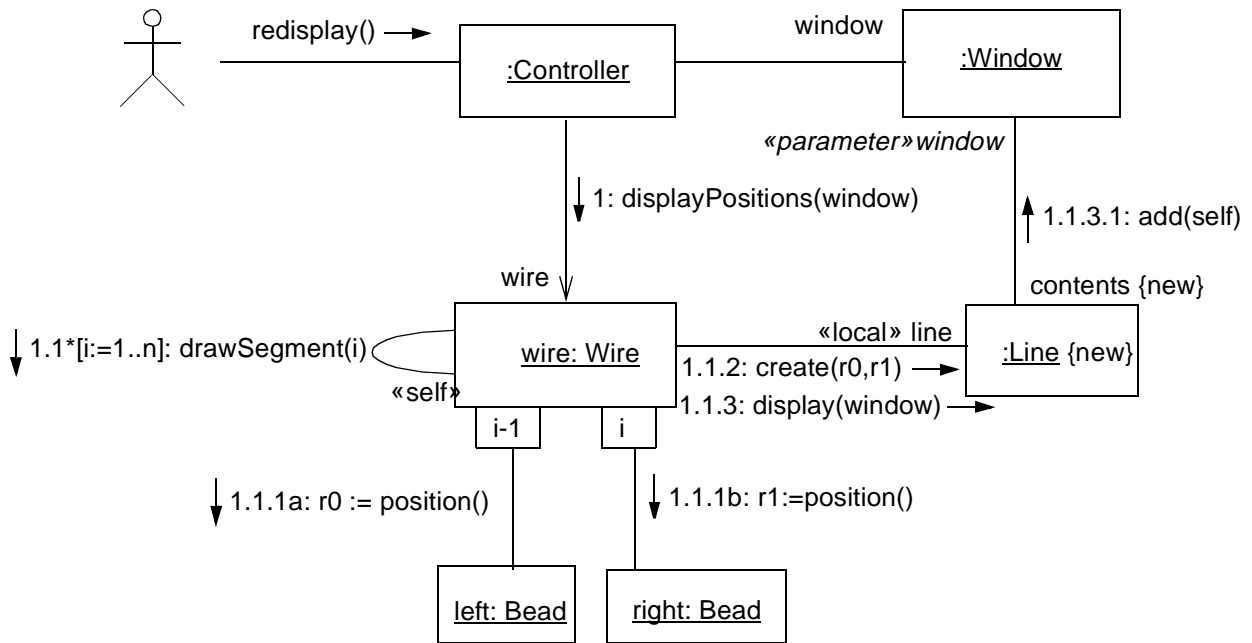

Figure 3-50 Collaboration Diagram at instance level, presenting Objects, Links, and Stimuli.

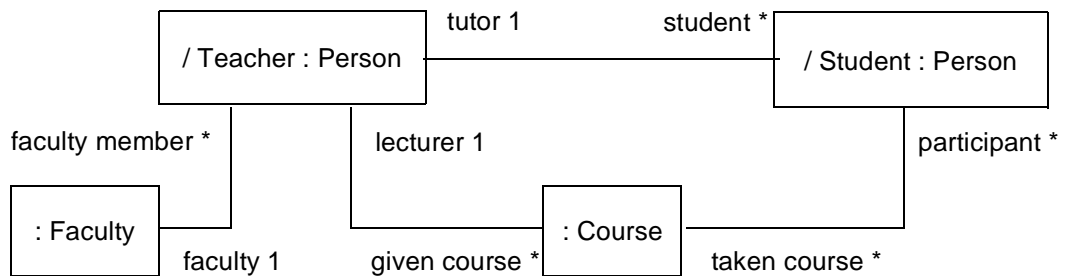

Figure 3-51 Collaboration Diagram at specification level, presenting ClassifierRoles and AssociationRoles.

3 UML Notation

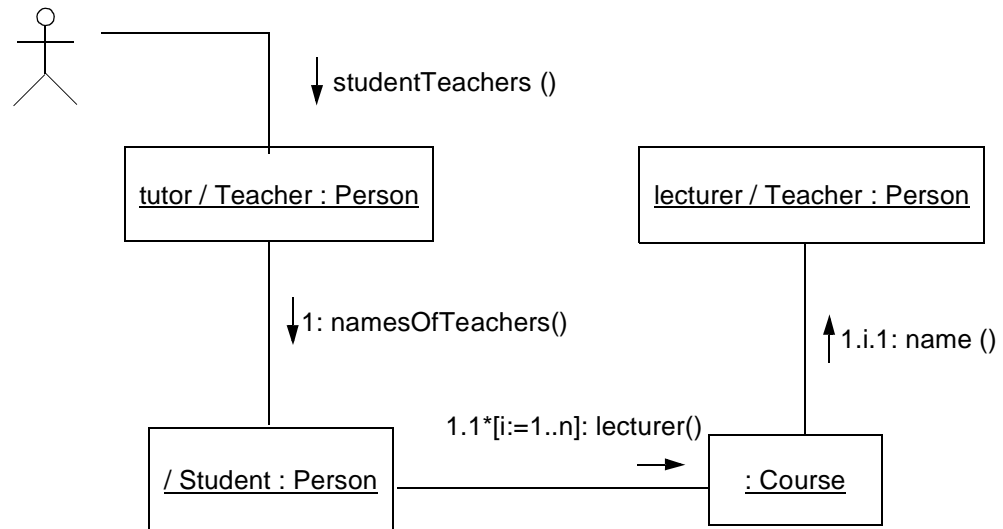

Figure 3-52 Collaboration Diagram at instance level in which some of the Objects play the same role. The instances conform to the Collaboration shown in Figure 3-51 on page 3-113.

3.65.4 Mapping

A collaboration diagram maps to a Collaboration, possibly together with an Interaction. The mapping of each kind of icon is described in Section 3.69, “Collaboration Roles,” on page 3-118, below. The mapping of the stereotypes is explained in Section 3.48.

3.66 Pattern Structure

3.66.1 Semantics

A Collaboration can be used to specify the implementation of design constructs. For this purpose, it is necessary to specify its context and interactions. It is also possible to view a Collaboration as a single entity from the “outside.” For example, this could be used to identify the presence of design patterns within a system design. A pattern is a parameterized Collaboration. In each use of the pattern, actual Classes are substituted for the parameters in the pattern definition.

Note that *patterns* as defined in *Design Patterns* by Gamma, Helm, Johnson, and Vlissides include much more than structural descriptions. UML describes the structural aspects and some behavioral aspects of design patterns; however, UML notation does not include other important aspects of patterns, such as usage trade-offs or examples. These must be expressed in text or tables.

3.66.2 Notation

A use of a Collaboration is shown as a dashed ellipse containing the name of the Collaboration. A dashed line is drawn from the collaboration symbol to each of the symbols denoting Objects or Classes (depending on whether it appears within an object diagram or a class diagram) that participate in the Collaboration. Each line is labeled by the *role* of the participant. The roles correspond to the names of elements within the context for the Collaboration; such names in the Collaboration are treated as parameters that are bound to specify elements on each occurrence of the pattern within a model. Therefore, a collaboration symbol can show the use of a design pattern together with the actual Classes that occur in that particular use of the pattern.

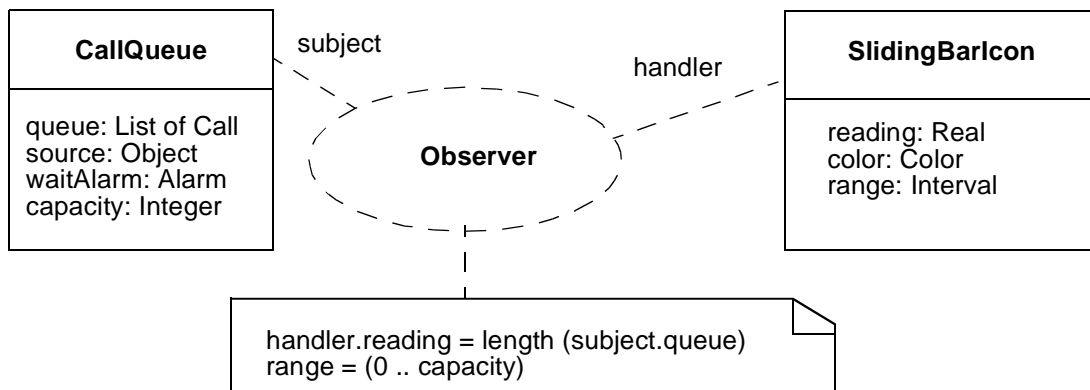

Figure 3-53 Use of a Collaboration.

As a Collaboration is a GeneralizableElement, it may have Generalization relationships to other Collaborations. In this way it is possible to define one Collaboration to be a specialization of another Collaboration. It is depicted by the ordinary Generalization arrow from the dashed ellipse representing the child Collaboration to the icon of the parent Collaboration. The roles of the child Collaborations may be specializations of roles in the parent Collaboration.

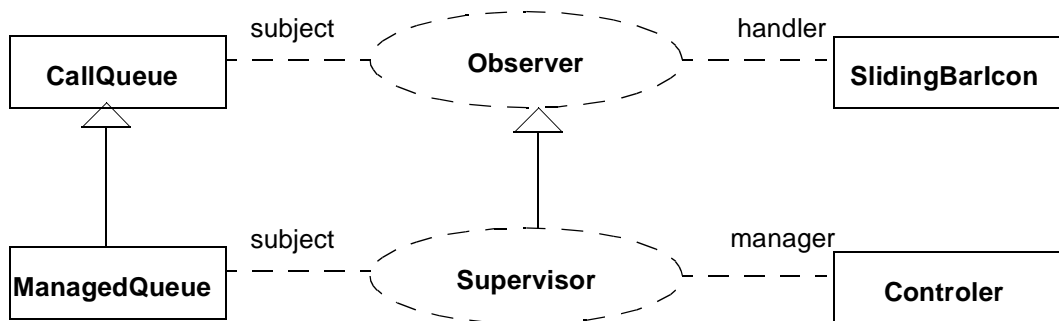

Figure 3-54 Specialization of a Collaboration.

3 UML Notation

A dashed arrow with a closed, hollow arrow-head is used to show that a Collaboration is a realization of an Operation or a Classifier. This relationship can also be presented in textual form within the Collaboration symbol.

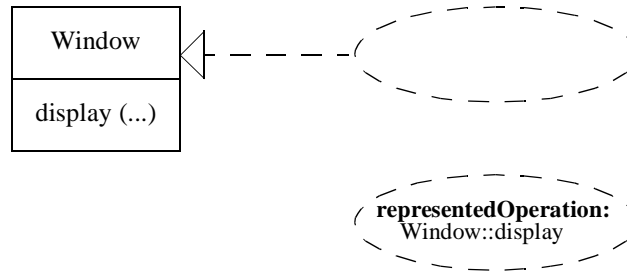

Figure 3-55 The relationship between a Collaboration and the element it is realizing can be shown either as a dashed arrow with a closed, hollow arrow-head from the Collaboration to the realized element, or in text.

3.66.3 Mapping

A collaboration usage symbol maps into a Collaboration. For each class symbol attached by an arrow to the pattern occurrence symbol, the corresponding Class is bound to the template parameter that is the *base* association target of the ClassifierRole in the Pattern with the name equal to the name on the arrow.

A dashed arrow from a Collaboration symbol to a Classifier or to an Operation is mapped onto the *representedClassifier* and onto the *representedOperation* association of the Collaboration, respectively.

3.67 Collaboration Contents

The contents of a Collaboration is a collection of roles specifying how Objects and Links cooperate within a given context for a particular purpose, such as performing an Operation or a Use case. A Collaboration is a fragment of a larger complete model that is intended for a particular purpose.

3.67.1 Semantics

A *Collaboration diagram* shows one or more roles together with their contents, relationships, and neighbor roles, plus additional relationships and Classes as needed. To use a Collaboration, each role must be bound to an actual Class (or collection of Classes, if multiple classification is used) that (jointly) support the Operations required of the role. The additional elements express additional requirements that cannot be modelled with roles, such as Generalizations between roles.

3.67.2 Notation

A collaboration is shown as a graph of class boxes or object boxes together with connecting lines. These icons map onto ClassifierRoles, AssociationRoles, Objects, and Links, respectively (see Section 3.69, “Collaboration Roles,” on page 3-118, below).

However, a collaboration diagram may also contain other elements, like Classes and Generalizations, to express additional information. These elements are shown using their ordinary icons.

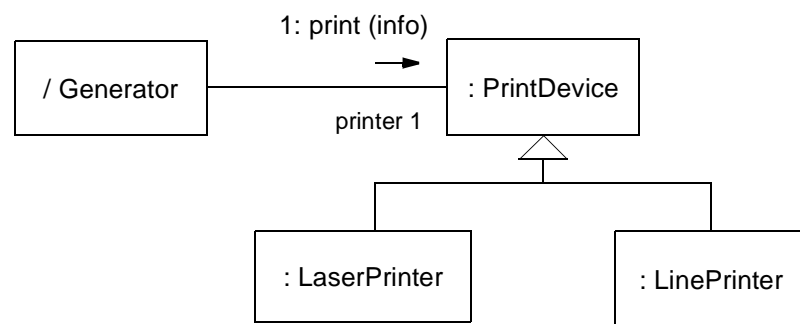

Figure 3-56 A collaboration diagram showing different roles, together with two additional Generalization relationships as constraining elements.

3.67.3 Mapping

The mapping of roles and instances are described below. Any constraining element, like a generalization arrow, is mapped onto its usual model element, such as Generalization. These elements are referenced by the Collaboration as its *constraining elements*.

3.68 Interactions

A collaboration of objects interacts to accomplish a purpose (such as performing an Operation) by exchanging Stimuli. These may include both sending Signals and invocations of Operations, as well as more implicit interaction through conditions and time events. A specific pattern of communication exchanges to accomplish a specific purpose is called an *interaction*.

3.68.1 Semantics

An *Interaction* is a behavioral specification that comprises a sequence of communications exchanged among a set of Objects within a Collaboration to accomplish a specific purpose, such as the implementation of an Operation. To specify an Interaction, it is first necessary to specify a Collaboration; that is, to establish the roles that interact and their relationships. Then, the possible interaction sequences are

3 UML Notation

specified. These can be specified in a single description containing conditionals (branches or conditional signals), or they can be specified by supplying multiple descriptions, each describing a particular path through the possible execution paths.

One communication is specified with a Message; it specifies the sender and the receiver roles, as well as the Action that will cause the communication to take place. The Action specifies what kind of communication that should take place, such as sending a Signal or invoking an Operation, together with a sequence of expressions that determine the arguments to be supplied. The Action may also contain a recurrence expression stating a guard or an iteration of the performance of the Action.

When the Action is performed, a Stimulus is dispatched conforming to the Message. The Stimulus contains references to the sender and the receiver Objects playing the sender role and the receiver role of the Message, as well as a sequence of Object references being the result of evaluating the argument expressions of the dispatching Action.

3.68.2 Notation

Interactions are shown as sequence diagrams or as collaboration diagrams. Both diagram formats show the execution of collaborations. However, sequence diagrams do not show the relationships between the Objects or the Attribute values of the Objects; therefore, they do not fully show the context aspect of a Collaboration. Sequence diagrams do show the behavioral aspect of Collaborations explicitly, including the time sequence of Stimuli and explicit representation of method activations. Sequence diagrams are described in “Part 7 - Sequence Diagrams” on page 3-97. Collaboration diagrams show the full context of an interaction, including the Objects and their relationships relevant to a particular interaction. The sequencing of the Stimuli is done using sequence numbers, since distributing them along a time axis, like in Sequence diagrams, is not possible in this kind of diagram. (In fact, in some cases it is convenient to use sequence numbers in combination with a time axis.) The contents of collaboration diagrams are described in the following section.

3.68.3 Example

See Section 3.65, “Collaboration Diagram” for examples of Interactions and their Collaborations.

3.69 Collaboration Roles

3.69.1 Semantics

A ClassifierRole defines a role to be played by an Object within a collaboration. The role describes the type of Object that may play the role, such as required Operations and Attributes, and describes its relationships to other roles. The relationships to other roles are defined by AssociationRoles. These describe the required Links between the Objects, i.e. a subset of the existing Links.

3.69.2 Notation

A ClassifierRole is shown using a class rectangle symbol. Normally, only the name compartment is shown, but the attribute and operation compartments may also be shown when needed. The name compartment contains the string:

*‘/ ClassifierRoleName ‘:’ ClassifierName [‘,’ ClassifierName]**

The name of the Classifier (or Classifiers if multiple classification is used) can include a full pathname of enclosing Packages, if necessary. A tool will normally permit shortened pathnames to be used when they are unambiguous. The Package names precede the Classifier name and are separated by double colons. For example:

```
display_window: WindowingSystem::GraphicWindows::Window
```

A stereotype may be shown textually (in guillemets above the name string) or as an icon in the upper right corner. A ClassifierRole representing a set of Objects can include a multiplicity indicator (such as “**”) in the upper right corner of the class box.

An AssociationRole is shown with the usual association line. The name string of the Association Role follows the same syntax as for the ClassifierRole. If the name is omitted, a line connected to Classifier Role symbols denotes an Association Role. The information attached to the ends of the AssociationRole, i.e. to the AssociationEndRoles, are shown using the same notation as for AssociationEnds.

An Object playing the role defined by a ClassifierRole is depicted by an object box, normally without an attribute compartment. The name of the Object is shown as a string:

*ObjectName ‘/ ClassifierRoleName ‘:’ ClassifierName [‘,’ ClassifierName]**

i.e. it starts with the name of the Object, followed by the complete name of the ClassifierRole, all underlined.

A Link is shown by a line between object boxes. Its name string follows the syntax of an Object playing a specific role.

3.69.3 Presentation options

The name of a ClassifierRole may be omitted. In this case, the colon is kept together with the Class name. The role name may be omitted only if there is only *one* role to be played by Objects of the base Class in the Collaboration.

The name of the Class may be omitted together with the colon. In this case, the diagram does not present the complete information regarding the Collaboration.

At least one of the Class name (together with the colon) or the role name (together with the slash) must be present to denote a ClassifierRole. Otherwise, the rectangle denotes an ordinary Class.

If the role is to be played by an Object originating from multiple Classes, the names of the Classes are shown in a comma separated list after the colon.

3 UML Notation

In an object box the Object name, the role name and / or the class name may be omitted. However, the colon should be kept in front of the class name, and the slash should be kept in front of the role name. The notation used is the same for Objects in general, with the possible addition of the name of the ClassifierRole which the Object conforms to.

Note, the name of an Instance is always underlined, whereas the name of a Classifier (including ClassifierRole) is never underlined. Furthermore, an un-named line between icons representing Instances is always a Link, and between icons representing Classifiers it is always an Association.

These tables summarize the different combinations of names:

Table 3-1 Syntax of Object names

syntax	explanation
<u>:C</u>	un-named Object originating from the Class C
<u>/R</u>	un-named Object playing the role R
<u>/R:C</u>	un-named Object originating from the Class C playing the role R
<u>O/R</u>	an Object named O playing the role R
<u>O:C</u>	an Object named O originating from the Class C
<u>O/R:C</u>	an Object named O originating from the Class C playing the role R
<u>O</u>	an Object named O

Table 3-2 Syntax of role names

syntax	explanation
/R	a role named R
:C	an un-named role with the <i>base</i> Class C
/R:C	a role named R with the <i>base</i> Class C

3.69.4 Example

See figures in Section 3.65, "Collaboration Diagram".

3.69.5 Mapping

A classifier role rectangle maps onto one ClassifierRole. The role name is the name of the ClassifierRole and the sequence of classifier names are the names of the *base* Classifiers. An association role line maps onto an AssociationRole attached to the ClassifierRoles corresponding to the rectangles at the end points of the line.

An object symbol maps onto an Object whose name is the *object* part of the name string. The Classes of the Object are those named according to the sequence of names in the *class* part of the string (or children of these Classes). The Object conforms to the ClassifierRole, whose name is the *role* part of the string.

3.70 Multiobject

3.70.1 Semantics

A multiobject represents a set of Objects on the “many” end of an Association. This is used to show Operations and Signals that address the entire set, rather than a single Object in it. The underlying static model is unaffected by this grouping. This corresponds to an Association with multiplicity “many” used to access a set of associated Objects.

3.70.2 Notation

A multiobject is shown as two rectangles in which the top rectangle is shifted slightly vertically and horizontally to suggest a stack of rectangles. A message arrow to the multi-object symbol indicates a Stimulus to the set of Objects (for example, a selection Operation to find an individual Object).

To perform an Operation on each Object in a set of associated Objects requires two Stimuli: 1) an iteration to the multi-object to extract Links to the individual Objects and then 2) a Stimulus sent to each individual Object using the (temporary) Link. This may be elided on a diagram by combining the arrows into a single arrow that includes an iteration and an application to each individual Object. The target rolenam takes a “many” indicator (*) to show that many individual Links are implied. Although this may be written as a single Stimulus, in the underlying model (and in any actual code) it requires the two layers of structure (iteration to find Links, message using each Link) mentioned previously.

An Object from the set is shown as a normal object symbol, but it may be attached to the multiobject symbol using a composition Link to indicate that it is part of the set. A message arrow to the simple object symbol indicates a Stimulus to an individual Object.

Typically a selection Stimulus to a multiobject returns a reference to an individual Object, to which the original sender then sends a Stimulus.

3 UML Notation

3.70.3 Example

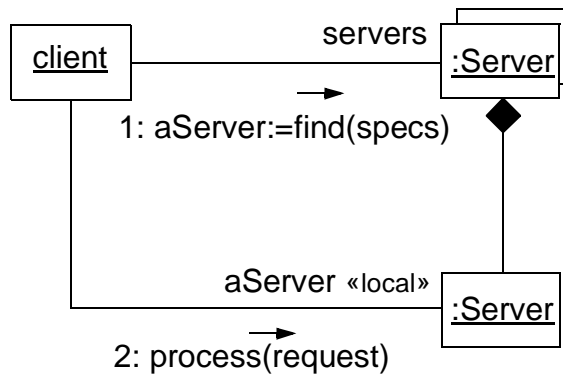

Figure 3-57 Multiobject

3.70.4 Mapping

A multi-object symbol maps to a set of Objects that together conforms to a ClassifierRole with multiplicity “many” (or whatever is explicitly specified). In other respects, it maps the same as an object symbol. (The stereotype is explained in Section 3.48.)

3.71 Active object

An *active object* is one that owns a thread of control and may initiate control activity. A passive object is one that holds data, but does not initiate control. However, a passive object may send Stimuli in the process of processing a request that it has received. In a collaboration diagram, a ClassifierRole that is an active class represents the active objects that occur during execution.

3.71.1 Semantics

An active object is an Object that owns a thread of control. Processes and tasks are traditional kinds of active objects.

3.71.2 Notation

A role for an active object is shown as a rectangle with a heavy border. Frequently, active object roles are shown as composites with embedded parts.

The property keyword `{active}` may also be used to indicate an active object.

3.71.3 Example

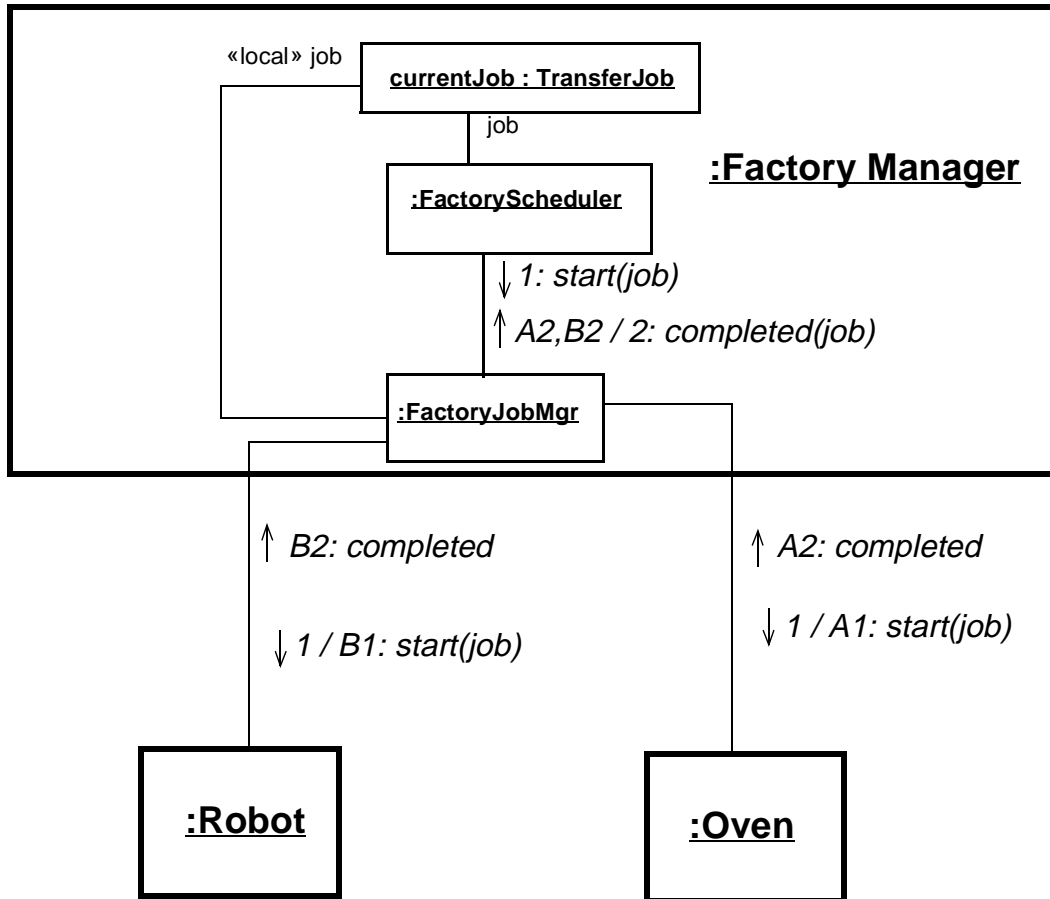

Figure 3-58 Composite Active Object

3.71.4 Mapping

An active object symbol maps as an object symbol does, with the addition that the *active* property is set.

3 UML Notation

3.72 Message and Stimulus

3.72.1 Semantics

In a collaboration diagram a Stimulus is a communication between two Objects that conveys information with the expectation that action will ensue. A Stimulus will cause an Operation to be invoked, raise a Signal, or an Object to be created or destroyed.

A Message is a specification of Stimulus, i.e. it specifies the roles that the sender and the receiver Objects should conform to, as well as the Action which will, when executed, dispatch a Stimulus that conforms to the Message.

3.72.2 Notation

Messages and Stimuli are shown as labeled arrows placed near an AssociationRole or a Link, respectively. The meaning is that the Link is used for transportation of the Stimulus to the target Object. The arrow points along the line in the direction of the receiving Object.

Control flow type

The following arrowhead variations may be used to show different kinds of communications:

filled solid arrowhead 

Procedure call or other nested flow of control. The entire nested sequence is completed before the outer level sequence resumes. May be used with ordinary procedure calls. May also be used with concurrently active objects when one of them sends a Signal and waits for a nested sequence of behavior to complete.

stick arrowhead 

Flat flow of control. Each arrow shows the progression to the next step in sequence. Normally all of the messages are asynchronous.

half stick arrowhead 

Asynchronous flow of control. Used instead of the stick arrowhead to explicitly show an asynchronous communication between two Objects in a procedural sequence.

dashed arrow with stick arrowhead 

Return from a procedure call. The return arrow may be suppressed as it is implicit at the end of an activation.

other variations

Other kinds of control may be shown, such as “balking” or “time-out;” however, these are treated as extensions to the UML core.

Arrow label

In the following the term *Message* is used, but the text applies to *Stimulus*, as well.

The label has the following syntax:

*predecessor guard-condition sequence-expression return-value := message-name
argument-list*

The label indicates the Message being sent, its arguments and return values, and the sequencing of the Message within the larger interaction, including call nesting, iteration, branching, concurrency, and synchronization.

Predecessor

The predecessor is a comma-separated list of sequence numbers followed by a slash (‘/’):

sequence-number ‘,’ . . . ‘/’

The clause is omitted if the list is empty.

Each sequence-number is a sequence-expression without any recurrence terms. It must match the sequence number of another Message.

The meaning is that the Message is not enabled until all of the communications whose sequence numbers appear in the list have occurred (once the communication has occurred the guard remains satisfied). Therefore, the guard condition represents a synchronization of threads.

Note that the Message corresponding to the numerically preceding sequence number is an implicit predecessor and need not be explicitly listed. All of the sequence numbers with the same prefix form a sequence. The numerical predecessor is the one in which the final term is one less. That is, number 3.1.4.5 is the predecessor of 3.1.4.6.

Sequence expression

The sequence-expression is a dot-separated list of sequence-terms followed by a colon (‘:’).

sequence-term ‘.’ . . . ‘:’

Each term represents a level of procedural nesting within the overall interaction. If all the control is concurrent, then nesting does not occur. Each sequence-term has the following syntax:

[*integer* | *name*] [*recurrence*]

3 UML Notation

The *integer* represents the sequential order of the Message within the next higher level of procedural calling. Messages that differ in one integer term are sequentially related at that level of nesting. Example: Message 3.1.4 follows Message 3.1.3 within activation 3.1. The *name* represents a concurrent thread of control. Messages that differ in the final name are concurrent at that level of nesting. Example: Message 3.1a and Message 3.1b are concurrent within activation 3.1. All threads of control are equal within the nesting depth.

The recurrence represents conditional or iterative execution. This represents zero or more Messages that are executed depending on the conditions involved. The choices are:

'*' '[' iteration-clause ']'	an iteration
'[' condition-clause ']'	a branch

An iteration represents a sequence of Messages at the given nesting depth. The iteration clause may be omitted (in which case the iteration conditions are unspecified). The iteration-clause is meant to be expressed in pseudocode or an actual programming language, UML does not prescribe its format. An example would be: **[i := 1..n]*.

A condition represents a Message whose execution is contingent on the truth of the condition clause. The condition-clause is meant to be expressed in pseudocode or an actual programming language; UML does not prescribe its format. An example would be: *[x > y]*.

Note that a branch is notated the same as an iteration without a star. One might think of it as an iteration restricted to a single occurrence.

The iteration notation assumes that the Messages in the iteration will be executed sequentially. There is also the possibility of executing them concurrently. The notation for this is to follow the star by a double vertical line (for parallelism): ***/*.

Note that in a nested control structure, the recurrence is not repeated at inner levels. Each level of structure specifies its own iteration within the enclosing context.

Signature

A signature is a string that indicates the name, the arguments, and the return value of an Operation, a Reception, a Message, or a Signal. These have the following properties.

Return-value

This is a list of names that designates the values returned at the end of the communication within the subsequent execution of the overall interaction. These identifiers can be used as arguments to subsequent Messages. If the Message does not return a value, then the return value and the assignment operator are omitted.

Message-name

This is the name of the event raised in the target Object (which is often the event of requesting an Operation to be performed). It may be implemented in various ways, *one* of which is an operation call. If it is implemented as a procedure call, then this is the name of the Operation, and the Operation must be defined on the Class of the receiver or inherited by it. In other cases, it may be the name of an event that is raised on the receiving Object. In normal practice with procedural overloading, both the message name and the argument list types are required to identify a particular Operation.

Argument list

This is a comma-separated list of arguments (actual parameters) enclosed in parentheses. The parentheses can be used even if the list is empty. Each argument is either an object reference, or an expression in pseudocode or an appropriate programming language (UML does not prescribe). The expressions may use return values of previous messages (in the same scope) and navigation expressions starting from the source object (that is, attributes of it and links from it and paths reachable from them).

3.72.3 Presentation Options

Instead of text expressions for arguments and return values, data tokens may be shown near a message. A token is a small circle labeled with the argument expression or return value name. It has a small arrow on it that points along the Message (for an argument) or opposite the Message (for a return value). Tokens represent arguments and return values. The choice of text syntax or tokens is a presentation option.

The syntax of Messages may instead be expressed in the syntax of a programming language, such as C++ or Smalltalk. All of the expressions on a single diagram should use the same syntax, however.

A return flow, may be explicitly shown with a dashed arrow.

3.72.4 Example

See Figure 3-50 on page 3-113 for examples within a diagram.

Samples of control message label syntax:

2: display (x, y)	simple Message
1.3.1: p:= find(specs)	nested call with return value
[x < 0] 4: invert (x, color)	conditional Message
A3,B4/ C3.1*: update ()	synchronization with other threads, iteration

3.72.5 Mapping

An arrow symbol maps either onto a Message or a Stimulus. If the arrow is attached to a line corresponding to an AssociationRole, it maps onto a Message, with the ClassifierRoles corresponding to the end-points of the line as the sender and the

3 UML Notation

receiver roles. If the line corresponds to a Link, the arrow maps onto a Stimulus, with the Objects corresponding to the end-points of the line as the sender and the receiver Instances. The line is the *communication connection* or the *communication link* of the Message or the Stimulus, respectively.

The control flow type sets the corresponding properties:

- *solid arrowhead*: a synchronous operation invocation
- *stick arrowhead*: flat flow of control (normally asynchronous)
- *half stick arrowhead*: an asynchronous operation invocation
- *dashed arrow with stick arrowhead*: return from an synchronous operation invocation

The predecessor expression, together with the sequence expression, determines the *predecessor* and *activation* (caller) associations between the Message and other Messages. The predecessors of the Message are the Messages corresponding to the sequence numbers in the predecessor list as well as the Message corresponding to the immediate preceding sequence number as the Message, i.e. 1.2.2 is the one preceding 1.2.3. The caller of the Message is the Message whose sequence number is truncated by one position, i.e. 1.2 is the caller of 1.2.3. The thread-of-control name maps onto a Classifier stereotyped *thread*, i.e. an active class.

The return of a value maps into a Message from the called Object to the caller with the dispatching Action being a ReturnAction. Its *predecessor* is the final Message within the procedure. Its *activation* is the Message that called the procedure.

The recurrence expression, the iteration clause, and the condition clause determine the recurrence value in the Action attached to the Message.

The operation name and the form of the signature determine the Operation attached to the CallAction associated with the Message. Similarly for a Signal and SendAction. The arguments of the signature determine the arguments associated with the CallAction and SendAction, respectively

In a procedural interaction, each arrow symbol also maps into a second Message representing the return flow, unless the return flow is explicitly shown. This Message has an *activation* Association to the original call Message. Its associated Action is a ReturnAction bearing the return values as arguments (if any).

3.73 Creation/Destruction Markers

3.73.1 Semantics

During the execution of an interaction some Objects and Links are created and some are destroyed. The creation and destruction of elements can be marked.

3.73.2 Notation

An Object or a Link that is created during an interaction has the standard constraint *new* attached to it. An Object or a Link that is destroyed during an interaction has the standard constraint *destroyed* attached. These constraints may be used even if the element has no name. Both constraints may be used together, but the standard constraint *transient* may be used in place of *new destroyed*.

3.73.3 Presentation options

Tools may use other graphic markers in addition to or in place of the keywords. For example, each kind of lifetime might be shown in a different color. A tool may also use animation to show the creation and destruction of elements and the state of the system at various times.

3.73.4 Example

See Figure 3-50 on page 3-113.

3.73.5 Mapping

Creation or destruction indicators map either into `CreateActions`, `DestroyActions`, or `TerminateActions` in the corresponding `ClassifierRoles`. The former two `Actions` dispatch the `Stimuli` that cause the changes. These status indicators are merely summaries of the total actions.

3 UML Notation

Part 9 - Statechart Diagrams

A statechart diagram can be used to describe the behavior of a model element such as an object or an interaction. Specifically, it describes possible sequences of states and actions through which the element can proceed during its lifetime as a result of reacting to discrete events (e.g., signals, operation invocations).

The semantics and notation described in this chapter are substantially those of David Harel's statecharts with modifications to make them object-oriented. His work was a major advance on the traditional flat state machines. Statechart notation also implements aspects of both Moore machines and Mealy machines, traditional state machine models.

3.74 Statechart Diagram

3.74.1 Semantics

Statechart diagrams represent the behavior of entities capable of dynamic behavior by specifying its response to the receipt of event instances. Typically, it is used for describing the behavior of classes, but statecharts may also describe the behavior of other model entities such as use-cases, actors, subsystems, operations, or methods.

3.74.2 Notation

A statechart diagram is a graph that represents a state machine. States and various other types of vertices (pseudostates) in the state machine graph are rendered by appropriate state and pseudostate symbols, while transitions are generally rendered by directed arcs that inter-connect them. States may also contain subdiagrams by physical containment or tiling. Note that every state machine has a top state which contains all the other elements of the entire state machine. The graphical rendering of this top state is optional.

The association between a state machine and its context does not have a special notation.

An example statechart diagram for a simple telephone object is depicted in Figure 3-59 on page 3-132.

3 UML Notation

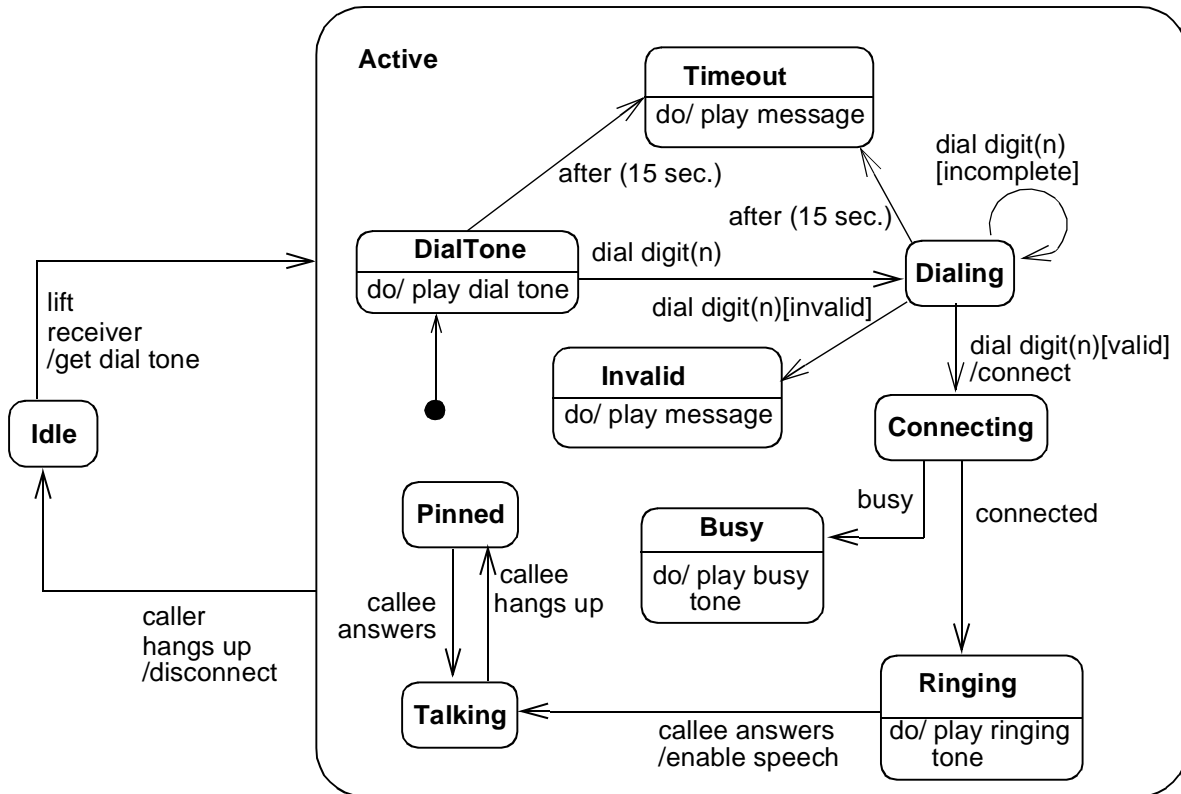

Figure 3-59 State Diagram

3.74.3 Mapping

A statechart diagram maps into a StateMachine. That StateMachine may be owned by a model element capable of dynamic behavior, such as classifier or a behavioral feature, which provides the context for that state machine. Different contexts may apply different semantic constraints on the state machine.

3.75 State

3.75.1 Semantics

A state is a condition during the life of an object or an interaction during which it satisfies some condition, performs some action, or waits for some event. A *composite* state is a state that, in contrast to a *simple* state, has a graphical decomposition. (Composite states and their notation are described in more detail in Section 3.76.) Conceptually, an object remains in a state for an interval of time. However, the semantics allow for modeling “flow-through” states which are instantaneous, as well as transitions that are not instantaneous.

A state may be used to model an ongoing activity. Such an activity is specified either by a nested state machine or by a computational expression.

3.75.2 Notation

A state is shown as a rectangle with rounded corners (Figure 3-60 on page 3-134). Optionally, it may have an attached name tab. The name tab is a rectangle, usually resting on the outside of the top side of a state and it contains the name of that state. It is normally used to keep the name of a composite state that has concurrent regions, but may be used in other cases as well (the Process state in Figure 3-65 on page 3-142 illustrates the use of the name tab).

A state may be optionally subdivided into multiple compartments separated from each other by a horizontal line. They are as follows:

- Name compartment

This compartment holds the (optional) name of the state, as a string. States without names are anonymous and are all distinct. It is undesirable to show the same named state twice in the same diagram, as confusion may ensue. Name compartments should not be used if a name tab is used and vice versa.

- Internal transitions compartment

This compartment holds a list of internal actions or activities that are performed while the element is in the state. The notation for such each of these list items has the following general format:

action-label '/' action-expression

The action label identifies the circumstances under which the action specified by the action expression will be invoked. The action expression may use any attributes and links that are in the scope of the owning entity. For list items where the action expression is empty, the backslash separator is optional.

A number of action labels are reserved for various special purposes and, therefore, cannot be used as event names. The following are the reserved action labels and their meaning:

- *entry*

This label identifies an action, specified by the corresponding action expression, which is performed upon entry to the state (entry action)

- *exit*

This label identifies an action, specified by the corresponding action expression, that is performed upon exit from the state (exit action)

- *do*

This label identifies an ongoing activity (“do activity”) that is performed as long as the modeled element is in the state or until the computation specified by the action expression is completed (the latter may result in a completion event being generated).

- *include*

This label is used to identify a submachine invocation. The action expression contains the name of the submachine that is to be invoked. Submachine states and the corresponding notation are described in Section 3.82, “Submachine States,” on page -147.

3 UML Notation

In all other cases, the action label identifies the event that triggers the corresponding action expression. These events are called internal transitions and are semantically equivalent to self transitions *except that the state is not exited or re-entered*. This means that the corresponding exit and entry actions are not performed. The general format for the list item of an internal transition is:

event-name '(' *comma-separated-parameter-list* ')' '[' *guard-condition* ']' '/'
action-expression

Each event name may appear more than once per state if the guard conditions are different. The event parameters and the guard conditions are optional. If the event has parameters, they can be used in the action expression through the current event variable.

3.75.3 Example

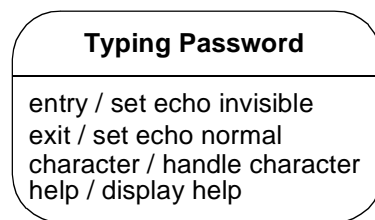

Figure 3-60 State

3.75.4 Mapping

A state symbol maps into a State. See “Composite States” on page 3-135 for further details on which kind of state.

The name string in the symbol maps to the name of the state. Two symbols with the same name map into the same state. However, each state symbol with no name (or an empty name string) maps into a distinct anonymous State.

A list item in the internal transition compartment maps into a corresponding Action associated with a state. An “entry” list item (i.e., an item with the “entry” label) maps to the “entry” role, an “exit” list item maps to the “exit” role, and a “do” item maps to the “doActivity” role. (The mapping of “include” items is discussed in Section 3.82, “Submachine States,” on page -147.)

A list item with an event name maps to a Transition associated with the “internal” role relative to the state. The action expression maps into the ActionSequence and Guard for the Transition. The event name and arguments map into an Event corresponding to the event name and arguments. The Transition has a *trigger* Association to the Event.

3.76 Composite States

3.76.1 Semantics

A composite state is decomposed into two or more concurrent substates (called *regions*) or into mutually exclusive disjoint substates. A given state may only be refined in one of these two ways. Naturally, any substate of a composite state can also be a composite state of either type.

A newly-created object takes its topmost default transition, originating from the topmost initial pseudostate. An object that transitions to its outermost final state is terminated.

Each region of a state may have initial pseudostates and final states. A transition to the enclosing state represents a transition to the initial pseudostate. A transition to a final state represents the completion of activity in the enclosing region. Completion of activity in all concurrent regions represents completion of activity by the enclosing state and triggers a completion event on the enclosing state. Completion of the top state of an object corresponds to its termination.

3.76.2 Notation

An expansion of a state shows its internal state machine structure. In addition to the (optional) name and internal transition compartments, the state may have an additional compartment that contains a region holding a nested diagram. For convenience and appearance, the text compartments may be shrunk horizontally within the graphic region.

An expansion of a state into concurrent substates is shown by tiling the graphic region of the state using dashed lines to divide it into regions. Each region is a concurrent substate. Each region may have an optional name and must contain a nested state diagram with disjoint states. The text compartments of the entire state are separated from the concurrent substates by a solid line. It is also possible to use a tab notation to place the name of a concurrent state. The tab notation is more space efficient.

An expansion of a state into disjoint substates is shown by showing a nested state diagram within the graphic region.

An initial pseudostate is shown as a small solid filled circle. In a top-level state machine, the transition from an initial pseudostate may be labeled with the event that creates the object; otherwise, it must be unlabeled. If it is unlabeled, it represents any transition to the enclosing state. The initial transition may have an action.

A final state is shown as a circle surrounding a small solid filled circle (a bull's eye). It represents the completion of activity in the enclosing state and it triggers a transition on the enclosing state labeled by the implicit activity completion event (usually displayed as an unlabeled transition), if such a transition is defined.

In some cases, it is convenient to hide the decomposition of a composite state. For example, the state machine inside a composite state may be very large and may simply not fit in the graphical space available for the diagram. In that case, the composite state may be represented by a simple state graphic with a special "composite" icon, usually in the lower right-hand corner. This icon, consisting of two horizontally placed and connected states, is an *optional*

3 UML Notation

visual cue that the state has a decomposition that is not shown in this particular statechart diagram (Figure 3-62 on page 136). Instead, the contents of the composite state are shown in a separate diagram. Note that the “hiding” here is purely a matter of graphical convenience and has no semantic significance in terms of access restrictions.

3.76.3 Examples

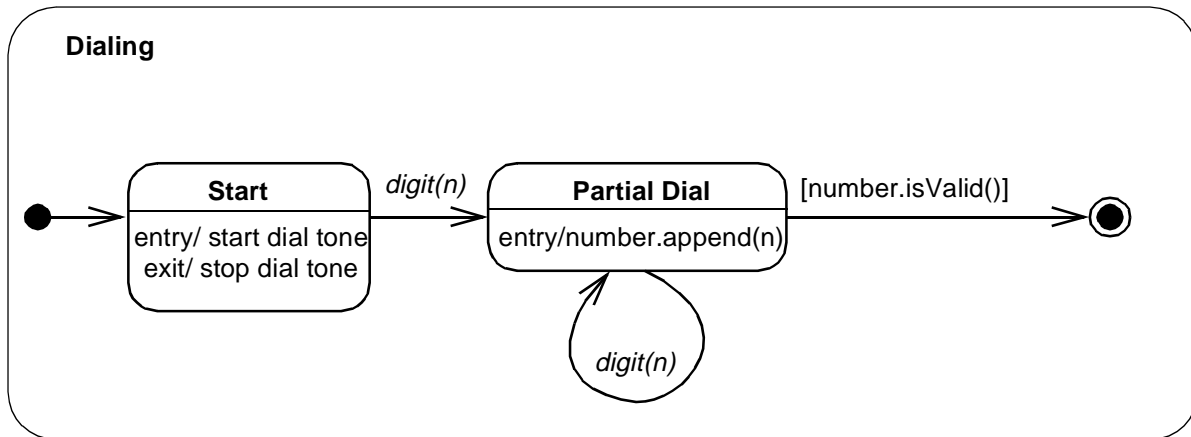

Figure 3-61 Sequential Substates

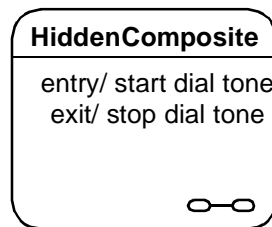

Figure 3-62 Composite State with hidden decomposition indicator icon

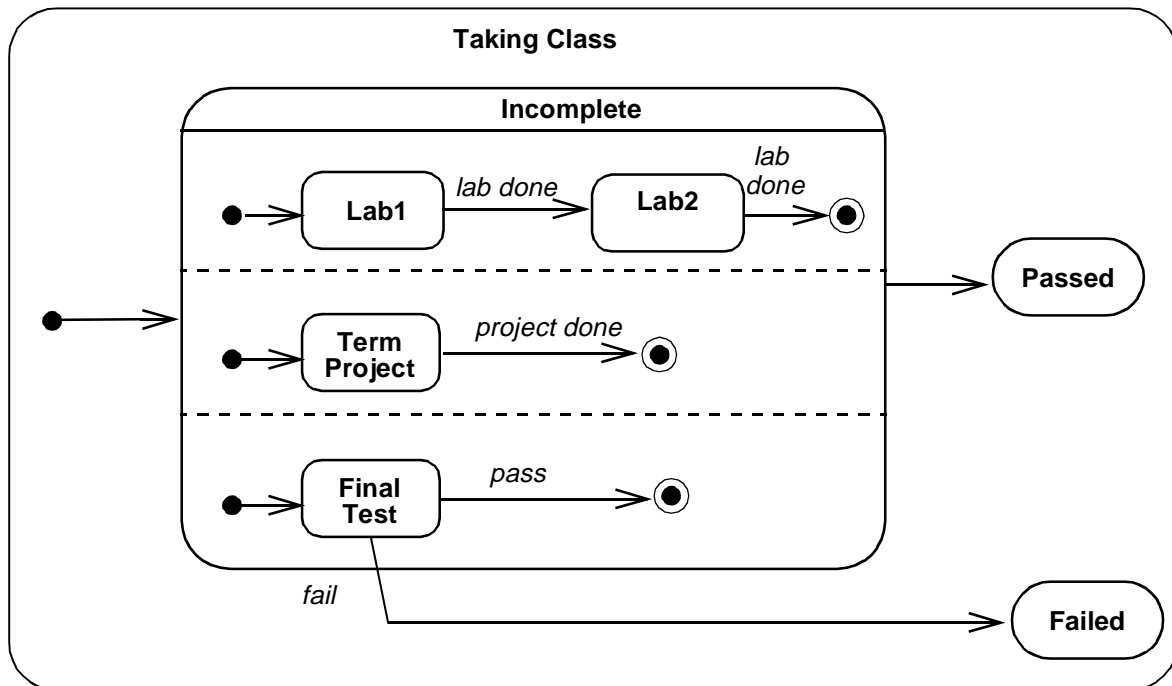

Figure 3-63 Concurrent Substates

3.76.4 Mapping

A state symbol maps into a State. If the symbol has no subdiagrams in it, it maps into a SimpleState. If it is tiled by dashed lines into regions, then it maps into a CompositeState with the *isConcurrent* value true; otherwise, it maps into a CompositeState with the *isConcurrent* value false. A region maps into a CompositeState with the *isRegion* value true and the *isConcurrent* value false.

An initial pseudostate symbol map into a Pseudostate of kind *initial*. A final state symbol maps to a *final* state.

3.77 Events

3.77.1 Semantics

An event is a noteworthy occurrence. For practical purposes in state diagrams, it is an occurrence that may trigger a state transition. Events may be of several kinds (not necessarily mutually exclusive).

3 UML Notation

- A designated condition becoming true (described by a Boolean expression) results in a change event instance. The event occurs whenever the value of the expression changes from false to true. Note that this is different from a guard condition. A guard condition is evaluated *once* whenever its event fires. If it is false, then the transition does not occur and the event is lost. R
- The receipt of an explicit signal from one object to another results in a signal event instance. It is denoted by the signature of the event as a trigger on a transition.
- The receipt of a call for an operation implemented as a transition by an object represents a call event instance.
- The passage of a designated period of time after a designated event (often the entry of the current state) or the occurrence of a given date/time is a TimeEvent. .

The event declaration has scope within the package it appears in and may be used in state diagrams for classes that have visibility inside the package. An event is *not* local to a single class.

3.77.2 Notation

A signal or call event can be defined using the following format:

event-name ‘(‘ *comma-separated-parameter-list* ‘)

A parameter has the format:

parameter-name ‘:’ *type-expression*

A signal can be declared using the «signal» keyword on a class symbol in a class diagram. The parameters are specified as attributes. A signal can be specified as a subclass of another signal. This indicates that an occurrence of the subevent triggers any transition that depends on the event or any of its ancestors.

An elapsed-time event can be specified with the keyword **after** followed by an expression that evaluates (at modeling time) to an amount of time, such as “**after** (5 seconds)” or **after** (10 seconds since exit from state A).” If no starting point is indicated, then it is the time since the entry to the current state. Other time events can be specified as conditions, such as **when** (date = Jan. 1, 2000).

A condition becoming true is shown with the keyword **when** followed by a Boolean expression. This may be regarded as a continuous test for the condition until it is true, although in practice it would only be checked on a change of values.

Signals can be declared on a class diagram with the keyword «signal» on a rectangle symbol. These define signal names that may be used to trigger transitions. Their parameters are shown in the attribute compartment. They have no operations. They may appear in a generalization hierarchy.

3.77.3 Example

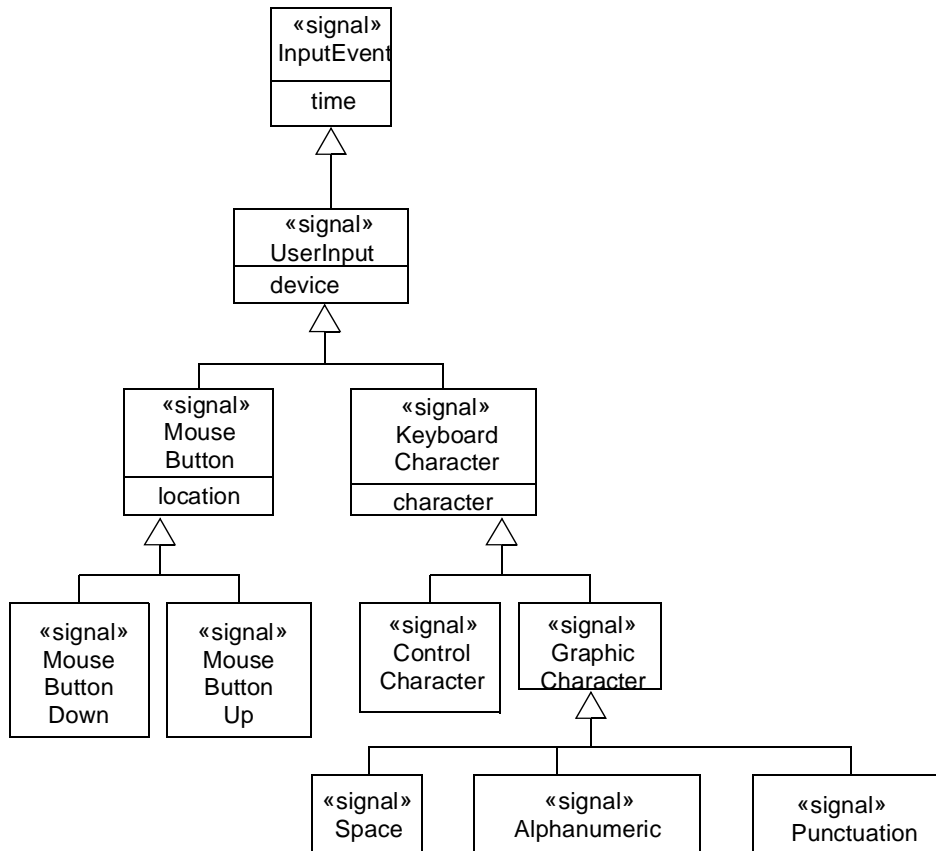

Figure 3-64 Signal Declaration

3.77.4 Mapping

A class box with stereotype «signal» maps into a Signal. The name and parameters are given by the name string and the attribute list of the box. Generalization arrows between signal class boxes map into Generalization relationships between the Signal.

The usage of an event string expression in a context requiring an event maps into an implicit reference of the Event with the given name. It is an error if various uses of the same name (including any explicit declarations) do not match.

3 UML Notation

3.78 Simple Transitions

3.78.1 Semantics

A simple transition is a relationship between two states indicating that an object in the first state will enter the second state and perform specific actions when a specified event occurs provided that certain specified conditions are satisfied. On such a change of state, the transition is said to “fire.” The trigger for a transition is the occurrence of the event labeling the transition. The event may have parameters, which are accessible by the actions specified on the transition as well as in the corresponding exit and entry actions associated with the source and target states respectively. Events are processed one at a time. If an event does not trigger any transition, it is discarded. If it can trigger more than one transition within the same sequential region (i.e., not in different concurrent regions), only one will fire. If these conflicting transitions are of the same priority, an arbitrary one is selected and triggered.

3.78.2 Notation

A transition is shown as a solid line originating from the *source* state and terminated by an arrow on the *target* state. It may be labeled by a *transition string* that has the following general format:

event-signature '[' *guard-condition* ']' '/' *action-expression*

The *event-signature* describes an event with its arguments:

event-name '(' *comma-separated-parameter-list* ')'

The *guard-condition* is a Boolean expression written in terms of parameters of the triggering event and attributes and links of the object that owns the state machine. The guard condition may also involve tests of concurrent states of the current machine, or explicitly designated states of some reachable object (for example, “**in** State1” or “**not in** State2”). State names may be fully qualified by the nested states that contain them, yielding pathnames of the form “State1::State2::State3.” This may be used in case same state name occurs in different composite state regions of the overall machine.

The *action-expression* is executed if and when the transition fires. It may be written in terms of operations, attributes, and links of the owning object and the parameters of the triggering event, or any other features visible in its scope. The corresponding action must be executed entirely before any other actions are considered. This model of execution is referred to as *run-to-completion* semantics. The action expression may be an action sequence comprising a number of distinct actions including actions that explicitly generate events, such as sending signals or invoking operations. The details of this expression are dependent on the action language chosen for the model.

Transition times

Names may be placed on transitions to designate the times at which they fire. See “Transition Times” on page 3-107.

3.79 Transitions to and from Concurrent States

3.78.3 Example

```
right-mouse-down (location) [location in window] / object := pick-object (location);  
object.highlight ()
```

The event may be any of the standard event types. Selecting the type depends on the syntax of the name (for time events, for example); however, SignalEvents and CallEvents are not distinguishable by syntax and must be discriminated by their declaration elsewhere.

3.78.4 Mapping

A transition string and the transition arrow that it labels together map into a Transition and its attachments. The arrow connects two state symbols. The Transition has the corresponding States as its source (the state at the tail) and destination (the state at the head) States in associations to the Transition.

The event name and parameters map into an Event element, which may be a SignalEvent, a CallEvent, a TimeExpression (if it has the proper syntax), or a ChangeEvent (if it is expressed as a Boolean expression). The event is attached as a “trigger” role in the association to the transition.

The guard condition maps into a Guard element attached to the Transition. Note that a guard condition is distinguished graphically from a change event specification by being enclosed in brackets.

An action expression maps into an Action attached as an “effect” role relative to the Transition.

3.79 Transitions to and from Concurrent States

A concurrent transition may have multiple source states and target states. It represents a synchronization and/or a splitting of control into concurrent threads without concurrent substates.

3.79.1 Semantics

A concurrent transition is enabled when all the source states are occupied. After a compound transition fires, all its destination states are occupied.

3.79.2 Notation

A concurrent transition includes a short heavy bar (a *synchronization* bar, which can represent synchronization, forking, or both). The bar may have one or more arrows from states to the bar (these are the *source states*). The bar may have one or more arrows from the bar to states (these are the *destination states*). A transition string may be shown near the bar. Individual arrows do not have their own transition strings.

3 UML Notation

3.79.3 Example

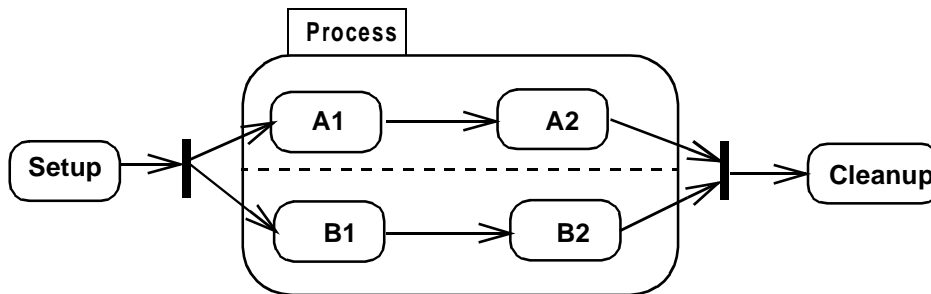

Figure 3-65 Concurrent Transitions

3.79.4 Mapping

A bar with multiple transition arrows leaving it maps into a fork pseudostate. A bar with multiple transition arrows entering it maps into a join pseudostate. The transitions corresponding to the incoming and outgoing arrows attach to the pseudostate as if it were a regular state. If a bar has multiple incoming and multiple outgoing arrows, then it maps into a join connected to a fork pseudostate by a single transition with no attachments.

3.80 Transitions to and from Composite States

3.80.1 Semantics

A transition drawn to the boundary of a composite state is equivalent to a transition to its initial point (or to a complex transition to the initial point of each of its concurrent regions, if it is concurrent). The entry action is always performed when a state is entered from outside.

A transition from a composite state indicates a transition that applies to each of the states within the state region (at any depth). It is “inherited” by the nested states. Inherited transitions can be masked by the presence of nested transitions with the same trigger.

3.80.2 Notation

A transition drawn to a composite state boundary indicates a transition to the composite state. This is equivalent to a transition to the initial pseudostate within the composite state region. The initial pseudostate must be present. If the state is a concurrent composite state, then the transition indicates a transition to the initial pseudostate of each of its concurrent substates.

Transitions may be drawn directly to states within a composite state region at any nesting depth. All entry actions are performed for any states that are entered on any transition. On a transition within a concurrent composite state, transition arrows from the synchronization bar may be drawn to one or more concurrent states. Any other concurrent regions start with their default initial pseudostate.

3.80 Transitions to and from Composite States

A transition drawn from a composite state boundary indicates a transition of the composite state. If such a transition fires, any nested states are forcibly terminated and perform their exit actions, then the transition actions occur and the new state is established.

Transitions may be drawn directly from states within a composite state region at any nesting depth to outside states. All exit actions are performed for any states that are exited on any transition. On a transition from within a concurrent composite state, transition arrows may be specified from one or more concurrent states to a synchronization bar; therefore, specific states in the other regions are irrelevant to triggering the transition.

A state region may contain a *history state indicator* shown as a small circle containing an ‘H.’ The history indicator applies to the state region that directly contains it. A history indicator may have any number of incoming transitions from outside states. It may have at most one outgoing unlabeled transition. This identifies the default “previous state” if the region has never been entered. If a transition to the history indicator fires, it indicates that the object resumes the state it last had within the composite region. Any necessary entry actions are performed. The history indicator may also be ‘H*’ for *deep history*. This indicates that the object resumes the state it last had at any depth within the composite region, rather than being restricted to the state at the same level as the history indicator. A region may have both shallow and deep history indicators.

3.80.3 Presentation options

Stubbed transitions

Nested states may be suppressed. Transitions to nested states are subsumed to the most specific visible enclosing state of the suppressed state. Subsumed transitions that do not come from an unlabeled final state or go to an unlabeled initial pseudostate may (but need not) be shown as coming from or going to *stubs*. A *stub* is shown as a small vertical line (bar) drawn inside the boundary of the enclosing state. It indicates a transition connected to a suppressed internal state. Stubs are not used for transitions to initial or from final states.

Note that events should be shown on transitions leading into a state, either to the state boundary or to an internal substate, including a transition to a stubbed state. Normally events should not be shown on transitions leading from a stubbed state to an external state. Think of a transition as belonging to its source state. If the source state is suppressed, then so are the details of the transition. Note also that a transition from a final state is summarized by an unlabeled transition from the composite state contour (denoting the implicit event “action complete” for the corresponding state).

3.80.4 Example

See Figure 3-64 on page 3-139 and Figure 3-65 on page 3-142 for examples of composite transitions. The following are examples of stubbed transitions and the history indicator.

3 UML Notation

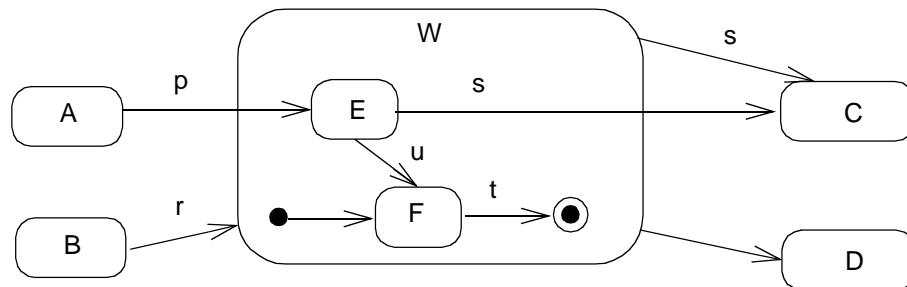

may be abstracted as

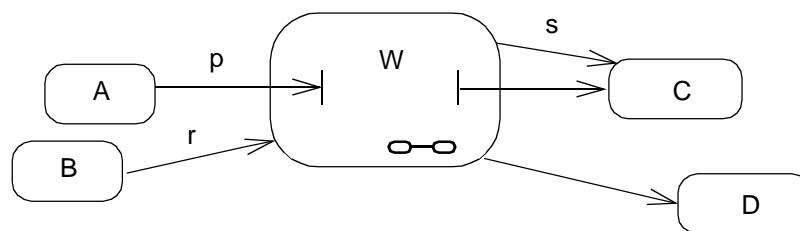

Figure 3-66 Stubbed Transitions

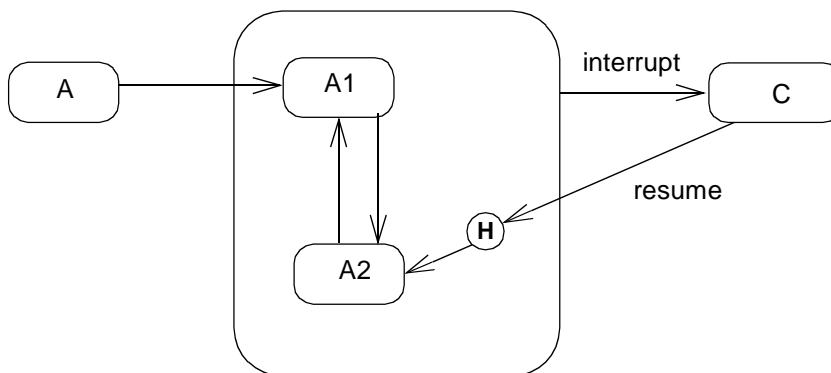

Figure 3-67 History Indicator

3.80.5 Mapping

An arrow to any state boundary, nested or not, maps into a Transition between the corresponding States and similarly for transitions directly to history states.

A history indicator maps into a Pseudostate of kind *shallowHistory* or *deepHistory*.

A stubbed transition does not map into anything in the model. It is a notational elision that indicates the presence of transitions to additional states in the model that are not visible in the diagram.

3.81 Factored Transition Paths

3.81.1 Semantics

By definition, a transition connects exactly two vertices in the state machine graph. However, since some of these vertices may be pseudostates—which are transient in nature—there is a need for describing chains of transitions that may be executed in the context of a single run-to-completion step. Such a transition is known as a *compound transition*.

As a practical measure, it is often useful to share segments of a compound transition. For example, two or more distinct compound transitions may come together and continue via a common path, sharing its action, and possibly terminating on the same target state. In other cases, it may be useful to split a transition into separate mutually exclusive (i.e., non-concurrent) paths.

Both of these examples of graphical factoring in which some transitions are shared resulting in simplified diagrams. However, factoring is also useful for modeling dynamically adaptive behavior. An example of this occurs when a single event may lead to any of a set of possible target states, but where the final target state is only determined as the result of an action (calculation) performed after the triggering of the compound transition.

Note that the splitting and joining of paths due to factoring is different from the splitting and joining of concurrent transitions described in Section 3.79. The sources and targets of these factored transitions are not concurrent.

3.81.2 Notation

Two or more transitions emanating from different non-concurrent states or pseudostates can terminate on a common junction point. This allows their respective compound transitions to share the path that emanates from that junction point. A junction point is represented by a small black circle. Alternatively, it may be represented by a diamond shape (see “Decisions” on page 3-154).

Two or more guarded transitions emanating from the same junction point represent a *static branch point*. Normally, the guards are mutually exclusive. This is equivalent to a set of individual transitions, one for each path through the tree, whose guard condition is the “and” of all of the conditions along the path. Note that the semantics of static branches is that all the outgoing guards are evaluated *before* any transition is taken.

Two or more guarded transitions emanating from a common *dynamic choice point* are used to model dynamic choices. In this case, the guards of the outgoing transitions are evaluated at the time the choice point has been reached. The value of these guards may be a function of some calculations performed in the actions of the incoming transition (s). A dynamic choice point is represented by a small white circle (reminiscent of a small state icon).

3 UML Notation

3.81.3 Examples

In Figure 3-68 a single junction point is used to merge and split transitions. Regardless of whether the junction point was reached from state State0 or from state State1, the outgoing paths are the same for both cases.

If the state machine in this example is in state State1 and b is less than 0 when event e1 occurs, the outgoing transition will be taken only if one of the three downstream guards is true. Thus, if a is equal to 6 at that point, no transition will be triggered.

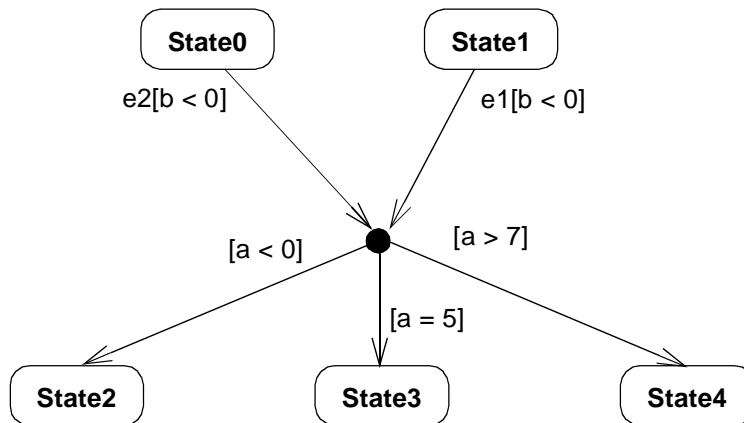

Figure 3-68 Junction points

In the dynamic choice point example in Figure 3-69, the decision on which branch to take is only made after the transition from State1 is taken and the choice point is reached. Note that the action associated with that incoming transition computes a new value for a. This new value can then be used to determine the outgoing transition to be taken. The use of the predefined condition[else] is recommended to avoid run-time errors.

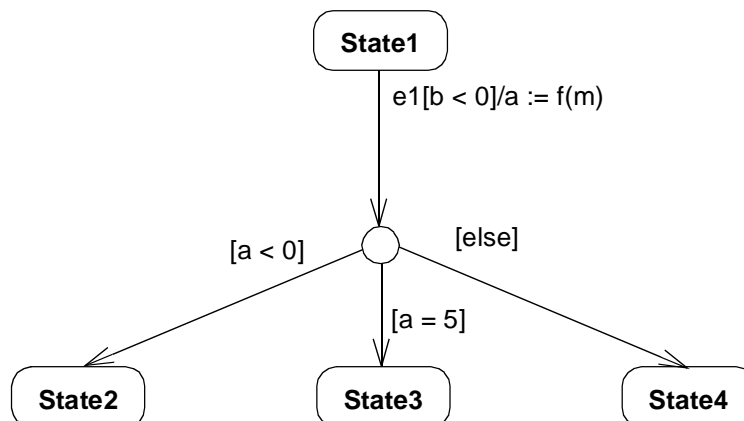

Figure 3-69 Dynamic choice points

3.82 Submachine States

3.82.1 Semantics

A submachine state represents the *invocation* of a state machine defined elsewhere. It is similar to a macro call in the sense that it represents a (graphical) shorthand that implies embedding of a complex specification within another specification. The submachine must be contained in the same context as the invoking state machine.

In the general case, an invoked state machine can be entered at any of its substates or through its default (initial) pseudostate. Similarly, it can be exited from any substate or as a result of the invoked state machine reaching its final state or by an “inherited” or “group” transition that applies to all substates in the submachine.

The non-default entry and exits are specified through special stub states.

3.82.2 Notation

The submachine state is depicted as a normal state with the appropriate “include” declaration within its internal transitions compartment (see Section 3.75, “State,” on page -132). The expression following the include reserved word is the name of the invoked submachine.

Optionally, the submachine state may contain one or more entry stub states and one or more exit stub states. The notation for these is similar to that used for stub ends of stubbed transitions, except that the ends are labeled. The labels represent the names of the corresponding substates within the invoked submachine. A pathname may be used if the substate is not defined at the top level of the invoked submachine. Naturally, this name must be a valid name of a state in the invoked state machine.

If the submachine is entered through its default pseudostate or if it is exited as a result of the completion of the submachine, it is not necessary to use the stub state notation for these cases. Similarly, a stub state is not required if the exit occurs through an explicit “group” transition that emanates from the boundary of the submachine state (implying that it applies to all the substates of the submachine).

Submachine states invoking the same submachine may occur multiple times in the same state diagram with different entry and exit configurations and with different internal transitions and exit and entry action specifications in each case.

3 UML Notation

3.82.3 Example

The following diagram shows a fragment from a statechart diagram in which a submachine (the FailureSubmachine) is invoked in a particular way. The actual submachine is presumably defined elsewhere and is not shown in this diagram. Note that the same submachine could be invoked elsewhere in the same statechart diagram with different entry and exit configurations.

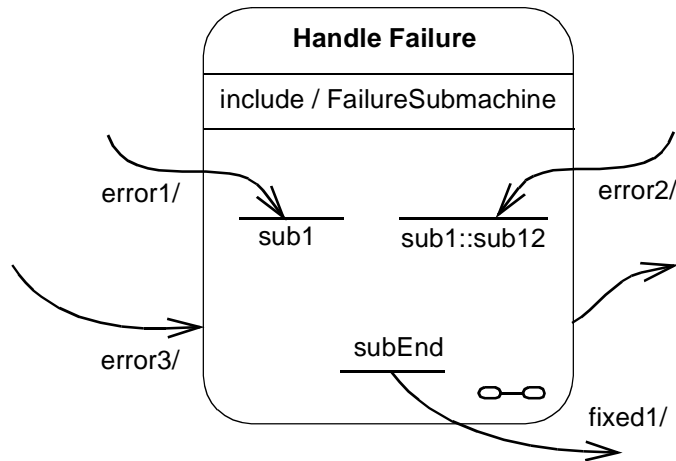

Figure 3-70 Submachine State

In the above example, the transition triggered by event “error1” will terminate on state “sub1” of the FailureSubmachine state machine. Since the entry point does not contain a path name, this means that “sub1” is defined at the top level of that submachine. In contrast, the transition triggered by “error2” will terminate on the “sub12” substate of the “sub1” substate (as indicated by the path name), while the “error3” transition implies taking of the default transition of the FailureSubmachine.

The transition triggered by the event “fixed1” emanates from the “subEnd” substate of the submachine. Finally, the transition emanating from the edge of the submachine state is taken as a result of the completion event generated when the FailureSubmachine reaches its final state.

3.82.4 Mapping

A submachine state in a statechart diagram maps directly to a SubmachineState in the metamodel. The name following the “include” reserved action label represents the state machine indicated by the “submachine” attribute. Stub states map to the Stub State concept in the metamodel. The label on the diagram corresponds to the pathname represented by the “referenceState” attribute of the stub state.

3.83 Synch States

3.83.1 Semantics

A synch state is for synchronizing concurrent regions of a state machine. It is used in conjunction with forks and joins to insure that one region leaves a particular state or states before another region can enter a particular state or states. The firing of outgoing transitions from a synch state can be limited by specifying a bound on the difference between the number of times outgoing and incoming transitions have fired.

3.83.2 Notation

A synch state is shown as a small circle with the upper bound inside it. The bound is either a positive integer or a star ('*') for unlimited. Synch states are drawn on the boundary between two regions when possible.

3.83.3 Example

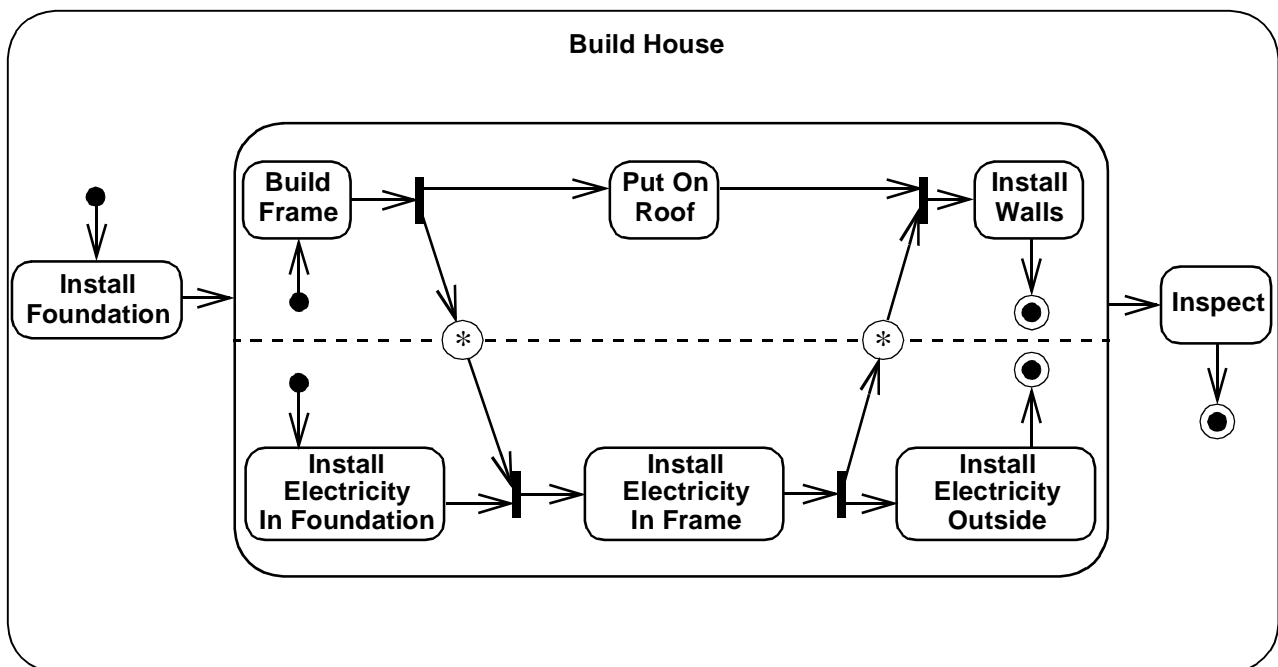

Figure 3-71 Synch states

3 UML Notation

3.83.4 Mapping

A synch state circle maps into a SynchState, contained by the least common containing state of the regions it is synchronizing. The number inside it maps onto the bound attribute of the synch state. A star (*) inside the synch state circle maps to a value of Unlimited for the bound attribute.

Part 10 - Activity Diagrams

3.84 Activity Diagram

3.84.1 Semantics

An activity graph is a variation of a state machine in which the states represent the performance of actions or subactivities and the transitions are triggered by the completion of the actions or subactivities. It represents a state machine of a procedure itself.

3.84.2 Notation

An activity diagram is a special case of a state diagram in which all (or at least most) of the states are action or subactivity states and in which all (or at least most) of the transitions are triggered by completion of the actions or subactivities in the source states. The entire activity diagram is attached (through the model) to a class, such as a use case, or to a package, or to the implementation of an operation. The purpose of this diagram is to focus on flows driven by internal processing (as opposed to external events). Use activity diagrams in situations where all or most of the events represent the completion of internally-generated actions (that is, procedural flow of control). Use ordinary state diagrams in situations where asynchronous events occur.

3 UML Notation

3.84.3 Example

Person::Prepare Beverage

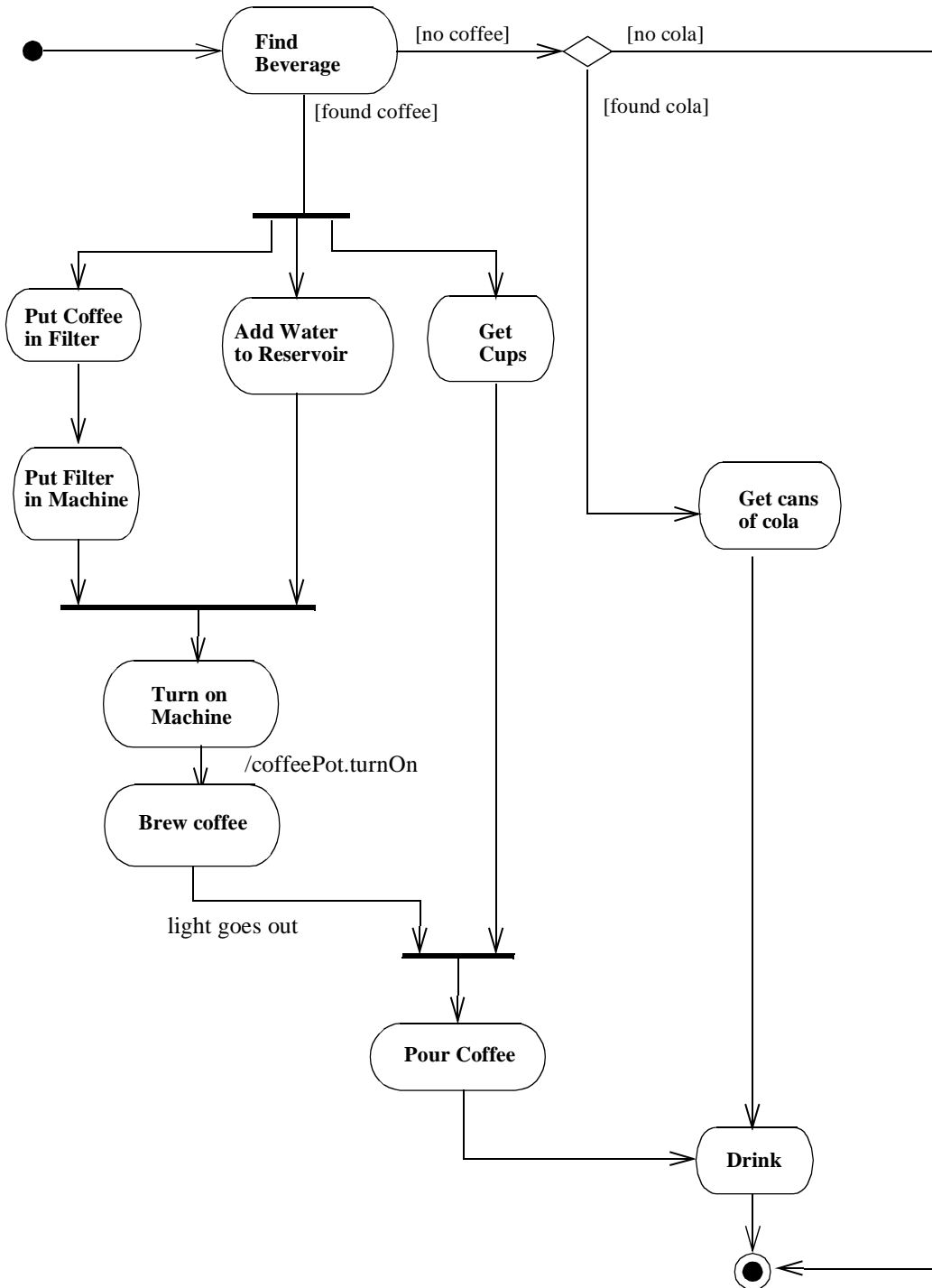

Figure 3-72 Activity Diagram

3.84.4 Mapping

An activity diagram maps into an ActivityGraph.

3.85 Action state

3.85.1 Semantics

An *action state* is a shorthand for a state with an entry action and at least one outgoing transition involving the implicit event of completing the entry action (there may be several such transitions if they have guard conditions). Action states should not have internal transitions or outgoing transitions based on explicit events, use normal states for this situation. The normal use of an action state is to model a step in the execution of an algorithm (a procedure) or a workflow process.

3.85.2 Notation

An action state is shown as a shape with straight top and bottom and with convex arcs on the two sides. The *action-expression* is placed in the symbol. The action expression need not be unique within the diagram.

Transitions leaving an action state should not include an event signature. Such transitions are implicitly triggered by the completion of the action in the state. The transitions may include guard conditions and actions.

3.85.3 Presentation options

The action may be described by natural language, pseudocode, or programming language code. It may use only attributes and links of the owning object.

Note that action state notation may be used within ordinary state diagrams; however, they are more commonly used with activity diagrams, which are special cases of state diagrams.

3.85.4 Example



Figure 3-73 Action States

3.85.5 Mapping

An action state symbol maps into an ActionState with the action-expression mapped to the entry action of the State. There is no *exit* nor any internal transitions. The State is normally anonymous.

3 UML Notation

3.86 Subactivity state

3.86.1 Semantics

A *subactivity state* invokes an activity graph. When a subactivity state is entered, the activity graph “nested” in it is executed as any activity graph would be. The subactivity state is not exited until the final state of the nested graph is reached, or when trigger events occur on transitions coming out of the subactivity state. Since states in activity graphs do not normally have trigger events, subactivity states are normally exited when their nested graph is finished. A single activity graph may be invoked by many subactivity states.

3.86.2 Notation

A subactivity state is shown in the same way as an action state with the addition of an icon in the lower right corner depicting a nested activity diagram. The name of the subactivity is placed in the symbol. The subactivity need not be unique within the diagram.

This notation is applicable to any UML construct that supports “nested” structure. The icon must suggest the type of nested structure.

3.86.3 Example



Figure 3-74 Subactivity States

3.86.4 Mapping

A subactivity state symbol maps into a `SubactivityState`. The name of the subactivity maps to a submachine link between the `SubactivityState` and a `StateMachine` of that name. The `SubactivityState` is normally anonymous.

3.87 Decisions

3.87.1 Semantics

A state diagram (and by derivation an activity diagram) expresses a decision when guard conditions are used to indicate different possible transitions that depend on Boolean conditions of the owning object. UML provides a shorthand for showing decisions and merging their separate paths back together.

3.87.2 Notation

A decision may be shown by labeling multiple output transitions of an action with different guard conditions.

The icon provided for a decision is the traditional diamond shape, with one incoming arrow and with two or more outgoing arrows, each labeled by a distinct guard condition with no event trigger. All possible outcomes should appear on one of the outgoing transitions. A predefined guard denoted “else” may be defined for at most one outgoing transition. This transition is enabled if all the guards labeling the other transitions are false.

The same icon can be used to merge decision branches back together, in which case it is called a merge. A merge has two or more incoming arrows and one outgoing arrow.

Note that a chain of decisions may be part of a complex transition, but only the first segment in such a chain may contain an event trigger label. All segments may have guard expressions. The transition coming from a merge may not have a trigger label or guard expressions.

3.87.3 Example

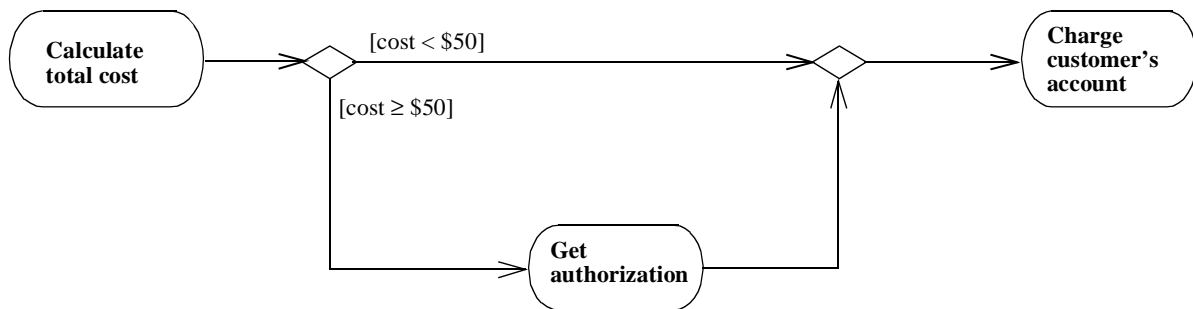

Figure 3-75 Decision and merge

3.87.4 Mapping

A decision symbol maps into a Pseudostate of kind *junction*. Each label on an outgoing arrow maps into a Guard on the corresponding Transition leaving the Pseudostate. A merge symbol maps also maps into a Pseudostate of kind *junction*.

3.88 Swimlanes

3.88.1 Semantics

Actions and subactivities may be organized into *swimlanes*. Swimlanes are used to organize responsibility for actions and subactivities according to class. They often correspond to organizational units in a business model.

3 UML Notation

3.88.2 Notation

An activity diagram may be divided visually into “swimlanes,” each separated from neighboring swimlanes by vertical solid lines on both sides. Each swimlane represents responsibility for part of the overall activity, and may eventually be implemented by one or more objects. The relative ordering of the swimlanes has no semantic significance, but might indicate some affinity. Each action is assigned to one swimlane. Transitions may cross lanes. There is no significance to the routing of a transition path.

3.88.3 Example

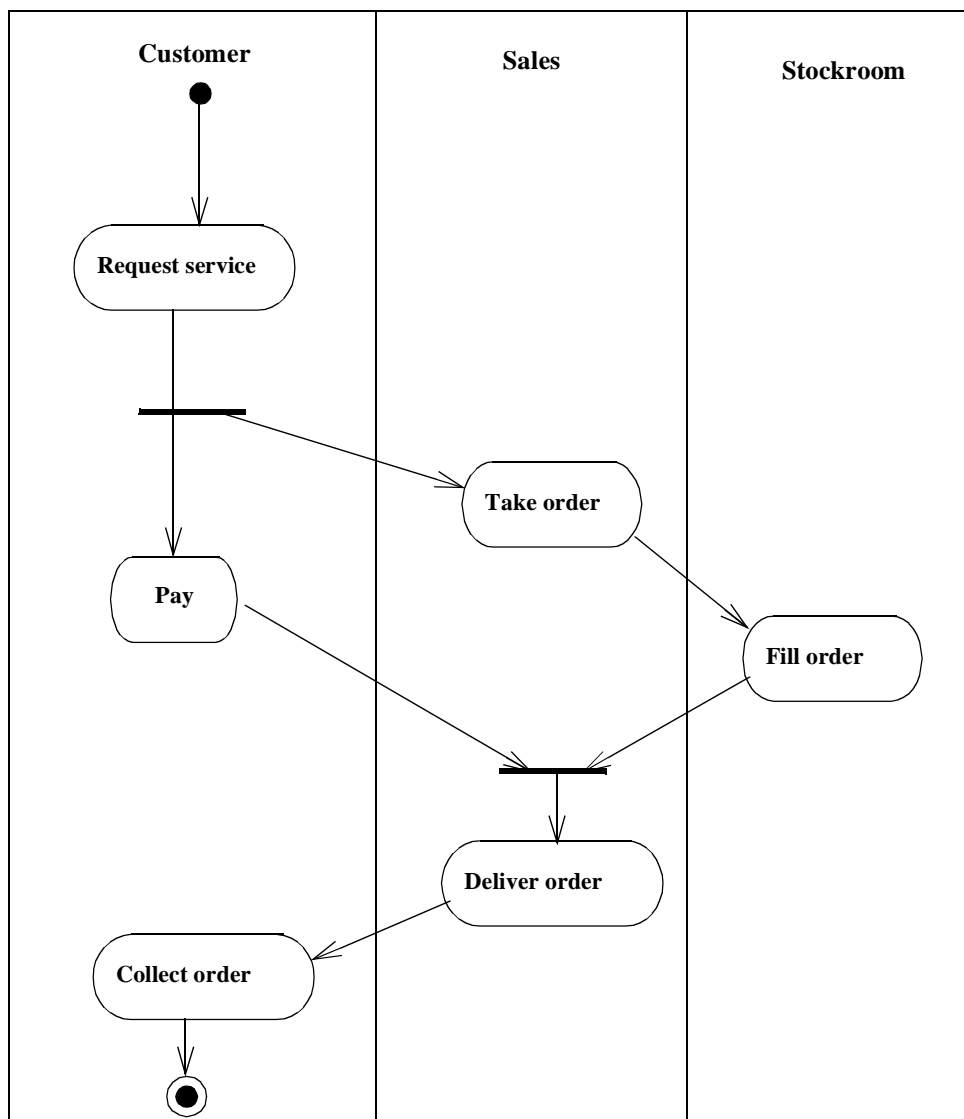

Figure 3-76 Swimlanes in Activity Diagram

3.89 Action-Object Flow Relationships

3.88.4 Mapping

A swimlane maps into a Partition of the States in the ActivityGraph. A state symbol in a swimlane causes the corresponding State to belong to the corresponding Partition.

3.89 Action-Object Flow Relationships

3.89.1 Semantics

Actions operate by and on objects. These objects either have primary responsibility for initiating an action, or are used or determined by the action. Actions usually specify calls sent between the object owning the activity graph, which initiates actions, and the objects that are the targets of the actions.

3.89.2 Notation

Object responsible for an action

In sequence diagrams, the object responsible for performing an action is shown by drawing a lifeline and placing actions on lifelines. See “Sequence Diagram” on page 3-98. Activity diagrams do not show the lifeline, but each action specifies which object performs its operation. These objects may also be related to the swimlane in some way. The actions within a swimlane can all be handled by the same object or by multiple objects.

Object flow

Objects that are input to or output from an action may be shown as object symbols. A dashed arrow is drawn from an action state to an output object, and a dashed arrow is drawn from an input object to an action state. The same object may be (and usually is) the output of one action and the input of one or more subsequent actions.

The control flow (solid) arrows must be omitted when the object flow (dashed) arrows supply a redundant constraint. In other words, when an state produces an output that is input to a subsequent state, that object flow relationship implies a control constraint.

Object in state

Frequently the same object is manipulated by a number of successive actions or subactivities. It is possible to show one object with arrows to and from all of the relevant actions and subactivities, but for greater clarity, the object may be displayed multiple times on a diagram. Each appearance denotes a different point during the object’s life. To distinguish the various appearances of the same object, the state of the object at each point may be placed in brackets and appended to the name of the object (for example, `PurchaseOrder[approved]`). This notation may also be used in collaboration and sequence diagrams.

3 UML Notation

3.89.3 Example

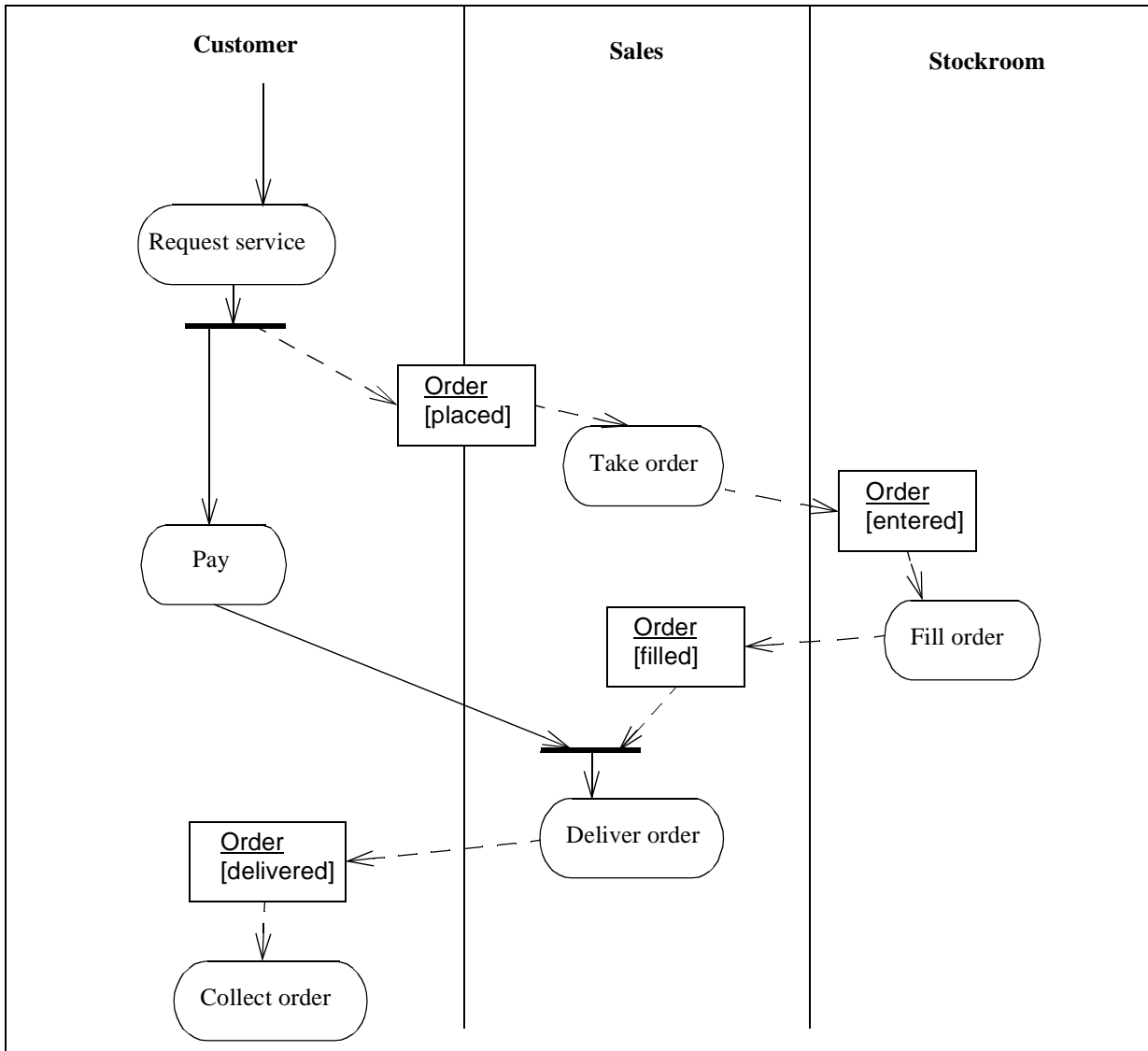

Figure 3-77 Actions and Object Flow

3.89.4 Mapping

An object flow symbol maps into an ObjectFlowState whose incoming and outgoing Transitions correspond to the incoming and outgoing arrows. The Transitions have no attachments. The class name and (optional) state name of the object flow symbol map into a Class or a ClassifierInState corresponding to the name(s). Solid and dashed arrows both map to transitions.

3.90 Control Icons

The following icons provide explicit symbols for certain kinds of information that can be specified on transitions. These icons are not necessary for constructing activity diagrams, but many users prefer the added impact that they provide.

3.90.1 Notation

Signal receipt

The receipt of a signal may be shown as a concave pentagon that looks like a rectangle with a triangular notch in its side (either side). The signature of the signal is shown inside the symbol. A unlabeled transition arrow is drawn from the previous action state to the pentagon and another unlabeled transition arrow is drawn from the pentagon to the next action state. A dashed arrow may be drawn from an object symbol to the notch on the pentagon to show the sender of the signal; this is optional.

Signal sending

The sending of a signal may be shown as a convex pentagon that looks like a rectangle with a triangular point on one side (either side). The signature of the signal is shown inside the symbol. A unlabeled transition arrow is drawn from the previous action state to the pentagon and another unlabeled transition arrow is drawn from the pentagon to the next action state. A dashed arrow may be drawn from the point on the pentagon to an object symbol to show the receiver of the signal, this is optional.

3 UML Notation

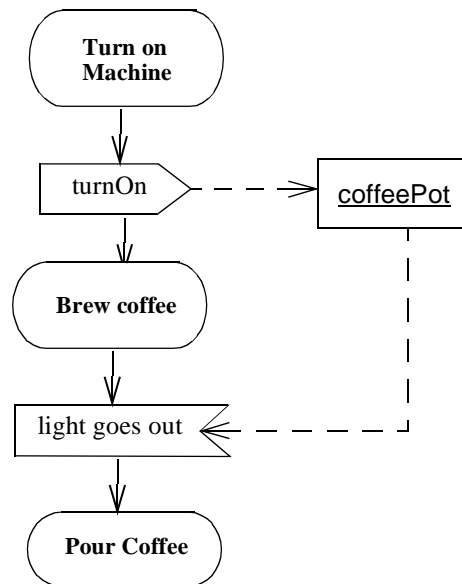

Figure 3-78 Symbols for Signal Receipt and Sending

Deferred events

A frequent situation is when an event that occurs must be “deferred” for later use while some other action or subactivity is underway. (Normally an event that is not handled immediately is lost.) This may be thought of as having an internal transition that handles the event and places it on an internal queue until it is needed or until it is discarded. Each state specifies a set of events that are deferred if they occur during the state and are not used to trigger a transition. If an event is not included in the set of deferrable events for a state, and it does not trigger a transition, then it is discarded from the queue even if it has already occurred. If a transition depends on an event, the transition fires immediately if the event is already on the internal queue. If several transitions are possible, the leading event in the queue takes precedence.

A deferrable event is shown by listing it within the state followed by a slash and the special operation *defer*. If the event occurs, it is saved and it recurs when the object transitions to another state, where it may be deferred again. When the object reaches a state in which the event is not deferred, it must be accepted or lost. The indication may be placed on a composite state or its equivalents, submachine and subactivity states, in which case it remains deferrable throughout the composite state. A contained transition may still be triggered by a deferrable event, whereupon it is removed from the queue.

It is not necessary to defer events on action states, because these states are not interruptible for event processing. In this case, both deferred and undeferred events that occur during the state are deferred until the state is completed. This means that the timing of the transition will be the same regardless of the relative order of the event and the state completion, and regardless of whether events are deferred.

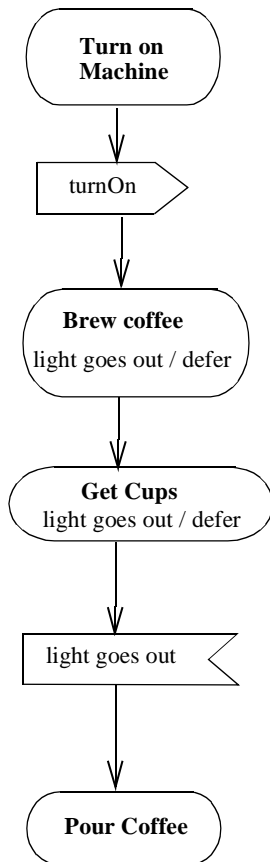

Figure 3-79 Deferred Event

3.90.2 Mapping

A signal receipt symbol maps into a state with no actions or internal transitions. Its specified event maps to a trigger event on the outgoing transition between it and the following state.

A signal send symbol maps into a `SendAction` on the incoming transition between it and the previous state.

A deferred event attached to a state maps into a `deferredEvent` association from the State to the Event.

3 UML Notation

3.91 Synch States

The SynchState notation may be omitted in Activity Diagrams when a SynchState has one incoming and one outgoing transition, and an unlimited bound. The semantics and mapping are the same as if the synch state circles were included, as defined for state machine notation.

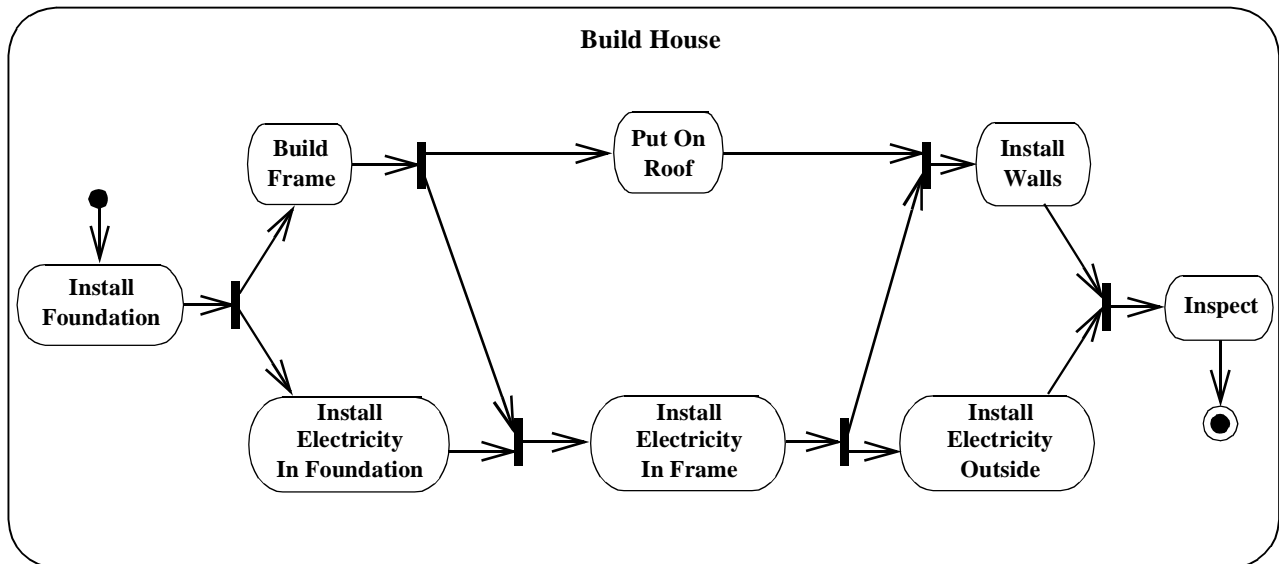

Figure 3-80 Synchronizing parallel activities

3.92 Dynamic Invocation

3.92.1 Semantics

The actions of an action state or the activity graph of a subactivity state may be executed more than once concurrently. The number of concurrent invocations is determined at runtime by a concurrency expression, which evaluates to a set of argument lists, one argument list for each invocation.

3.92.2 Notation

If the dynamic concurrency of an action or subactivity state is not always exactly one, its multiplicity is shown in the upper right corner of the state. Otherwise, nothing is shown.

3.92.3 Mapping

A multiplicity string in the upper right corner of an action or subactivity state maps to the same value in the dynamicMultiplicity attribute of the state. The presence of a multiplicity string also maps to a value of true for the isDynamic attribute of the state. If no multiplicity is present, the value of the isDynamic attribute is false.

3.93 *Conditional Forks*

In Activity Diagrams, transitions outgoing from forks may have guards. This means the region initiated by a fork transition might not start, and therefore is not required to complete at the corresponding join. The usual notation and mapping for guards may be used on the transition outgoing from a fork.

3 UML Notation

Part 11 - Implementation Diagrams

Implementation diagrams show aspects of implementation, including source code structure and run-time implementation structure. They come in two forms: 1) component diagrams show the structure of the code itself and 2) deployment diagrams show the structure of the run-time system. They can also be applied in a broader sense to business modeling in which the “code” components are the business procedures and documents and the “run-time structure” is the organization units and resources (human and other) of the business.

3.94 Component Diagram

3.94.1 Semantics

A component diagram shows the dependencies among software components, including source code components, binary code components, and executable components. For a business, “software” components are taken in the broad sense to include business procedures and documents. A software module may be represented as a component stereotype. Some components exist at compile time, some exist at link time, some exist at run time, and some exist at more than one time. A compile-only component is one that is only meaningful at compile time. The run-time component in this case would be an executable program.

A component diagram has only a type form, not an instance form. To show component instances, use a deployment diagram (possibly a degenerate one without nodes).

3.94.2 Notation

A component diagram is a graph of components connected by dependency relationships. Components may also be connected to components by physical containment representing composition relationships.

A diagram containing component types and node types may be used to show static dependencies, such as compiler dependencies between programs, which are shown as dashed arrows (dependencies) from a client component to a supplier component that it depends on in some way. The kinds of dependencies are implementation-specific and may be shown as stereotypes of the dependencies.

As a classifier, a component may have operations and may realize interfaces. The diagram may show these interfaces and calling dependencies among components, using dashed arrows from components to interfaces on other components.

3 UML Notation

3.94.3 Example

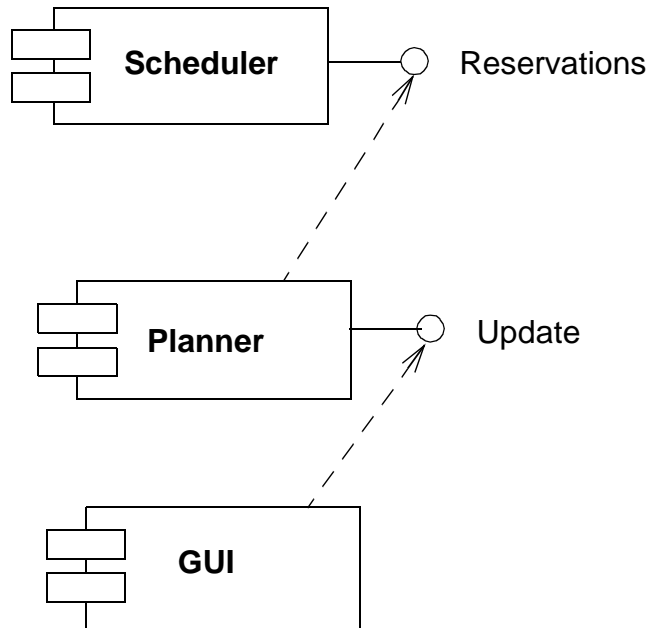

Figure 3-81 Component Diagram

3.94.4 Mapping

A component diagram maps to a static model whose elements include Components.

3.95 Deployment Diagram

3.95.1 Semantics

Deployment diagrams show the configuration of run-time processing elements and the software components, processes, and objects that live on them. Software component instances represent run-time manifestations of code units. Components that do not exist as run-time entities (because they have been compiled away) do not appear on these diagrams, they should be shown on component diagrams.

For business modeling, the run-time processing elements include workers and organizational units, and the software components include procedures and documents used by the workers and organizational units.

3.95.2 Notation

A deployment diagram is a graph of nodes connected by communication associations. Nodes may contain component instances. This indicates that the component lives or runs on the node. Components may contain objects, this indicates that the object resides on the component. Components are connected to other components by dashed-arrow dependencies (possibly through interfaces). This indicates that one component uses the services of another component. A stereotype may be used to indicate the precise dependency, if needed.

The deployment type diagram may also be used to show which components may reside on which nodes, by using dashed arrows with the stereotype «support» from the component symbol to the node symbol or by graphically nesting the component symbol within the node symbol.

Migration of component instances from node instance to node instance or objects from component instance to component instance may be shown using the «become» stereotype of the dependency relationship. In this case the component instance or object is resident on its node instance or component instance only part of the entire time.

Note that a process is just a special kind of object (see Active Object).

3 UML Notation

3.95.3 Example

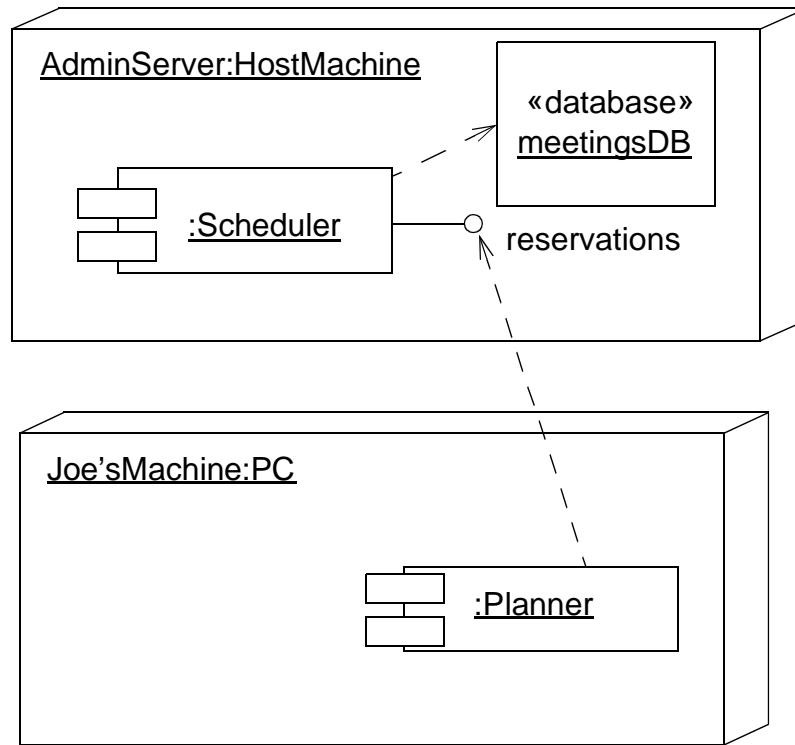

Figure 3-82 Nodes

3.95.4 Mapping

A deployment diagram maps to a static model whose elements include Nodes. It is not particularly distinguished in the model.

3.96 Node

3.96.1 Semantics

A node is a physical object that represents a processing resource, generally, having at least a memory and often processing capability as well. Nodes include computing devices but also human resources or mechanical processing resources. Nodes may be represented as type and as instances. Run time computational instances, both objects and component instances, may reside on node instances.

3.96.2 Notation

A node is shown as a figure that looks like a 3-dimensional view of a cube. A node type has a type name:

node-type

A node instance has a name and a type name. The node may have an underlined name string in it or below it. The name string has the syntax:

name ':' *node-type*

The name is the name of the individual node (if any). The node-type says what kind of a node it is. Either or both elements are optional; if the node-type is omitted, then so is the colon.

Dashed arrows with the keyword <<support>> show the capability of a node type to support a component type. Alternatively, this may be shown by nesting component symbols inside the node symbol.

Component instances and objects may be contained within node instance symbols. This indicates that the items reside on the node instances.

Nodes may be connected by associations to other nodes. An association between nodes indicates a communication path between the nodes. The association may have a stereotype to indicate the nature of the communication path (for example, the kind of channel or network).

3.96.3 Example

This example shows two nodes containing a component (cluster) that migrates from one node to another and a component (database) that remains in place.

3 UML Notation

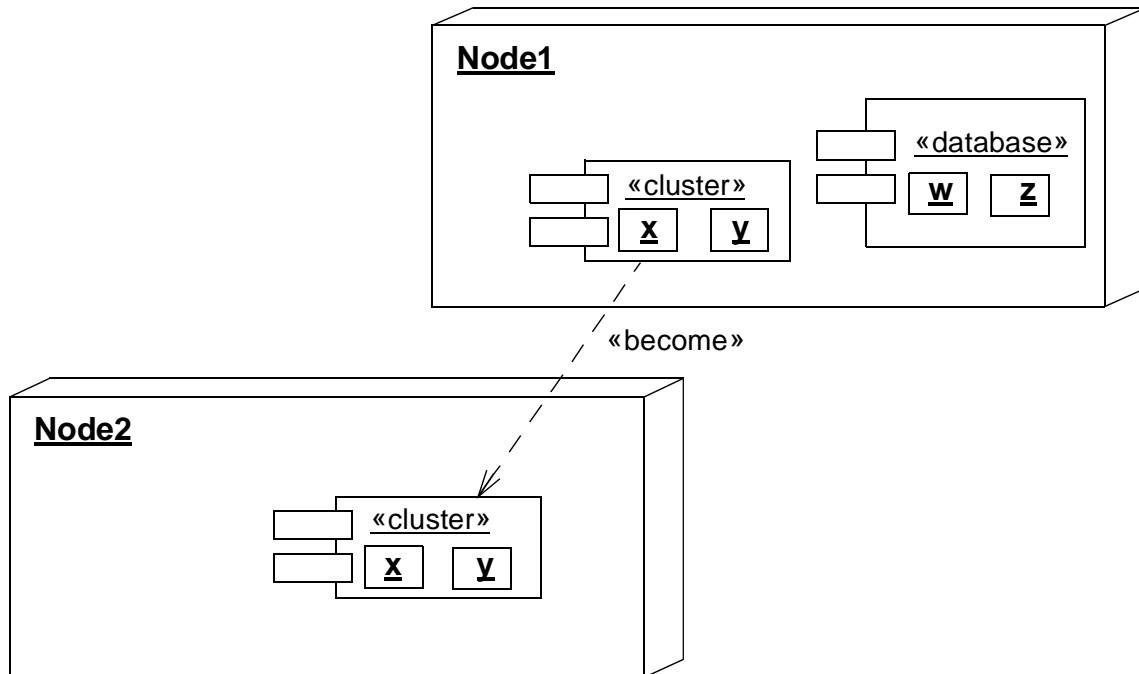

Figure 3-83 Use of Nodes to Hold Components

3.96.4 Mapping

A node maps to a Node.

A «support» arrow or the nesting of a component symbol within a node symbol maps into a residence metalink between the Component and the Node. The nesting of a component-instance symbol within a node-instance symbol maps to a residence metalink between the ComponentInstance and the NodeInstance.

3.97 Component

3.97.1 Semantics

A component type represents a distributable piece of implementation of a system, including software code (source, binary, or executable) but also including business documents, etc., in a human system. Components may be used to show dependencies, such as compiler and run-time dependencies or information dependencies in a human organization. A component instance represents a run-time implementation unit and may be used to show implementation units that have identity at run time, including their location on nodes.

3.97.2 Notation

A component is shown as a rectangle with two small rectangles protruding from its side. A component type has a type name:

component-type

A component instance has a name and a type. The name of the component and its type may be shown as an underlined string either within the component symbol or above or below it, with the syntax:

component-name ':' *component-type*

Either or both elements are optional. If the component-type is omitted, then so is the colon.

A property may be used to indicate the life-cycle stage that the component describes (source, binary, executable, or more than one of those). Components (including programs, DLLs, run-time linkable images, etc.) may be located on nodes.

Objects that reside on a component instance (that is, which are implemented by it) are shown as nested inside the component instance symbol. By analogy, classes that are implemented by a component may be shown as nested within it; this indicates implementation and not ownership.

Elements that reside in (i.e., are implemented by) a component are shown nested inside the component symbol. The visibility of a resident element to other components may be shown using the same notation as for the visibility of the contents of a package (prepending a visibility symbol to the name of the package). The meaning of the visibility depends on the nature of the component. For a source-language component (such as program text), it would control the accessibility of source-language constructs. For a run-time code component (such as executable code), it would control the ability of code in other components to call or otherwise access code in the component.

3 UML Notation

3.97.3 Example

The example shows a component with interfaces and also a component that contains objects at run time.

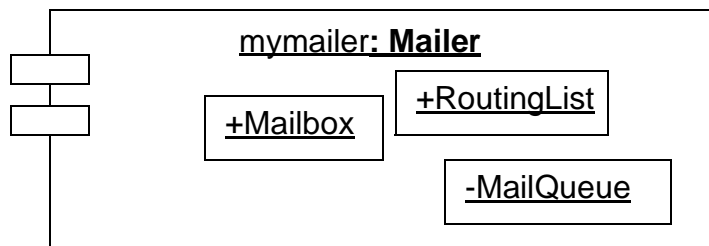
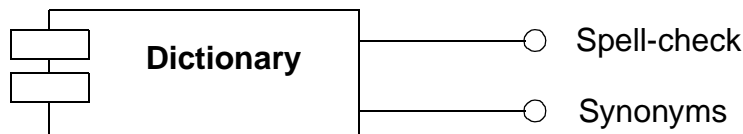

Figure 3-84 Components

3.97.4 Mapping

A component symbol maps to a Component.

The graphical nesting of an element (other than a component symbol) in a component symbol maps to an *ElementResidence* metalink between the *ModelElement* and the *Component*. Graphical nesting of a component symbol in another component symbol maps to a composition association. The graphical nesting of an instance symbol in a component instance symbol maps to a residence metalink between the *Instance* and the *ComponentInstance*.

Interface circles attached to the component symbol by solid lines map into *supports* Dependencies to Interfaces.

Index

Page numbers in italics indicate figures.

() *See* parentheses
{ } *See* braces
[] *See* square brackets
< > *See* angle brackets
« » *See* guillemets
: *See* colon
:: *See* double colon
. *See* dot
.. *See* double dot
... *See* ellipsis
+ *See* plus sign
- *See* minus sign
* *See* star
/ *See* slash
See pound sign
= *See* equal sign
> *See* right arrow

A

abstract 36
abstract class 37
abstract operation 44
access 18, 56, 57, 84
accessing a package 56
action expression 140
action state 153, 153
action-object flow relationships 157
activation 103, 104
active object 122, 123
activity diagram 151, 152, 156, 158
activity graph 151
activity state 153, 154, 158
actor 90, 92, 93
actor relationship 94, 94
addOnly (keyword) 67

adornment 68
 on association 62
 order 67
after (keyword) 138
aggregation 66
angle bracket
 for binding argument 52
argument list 127
arrow
 dashed
 for constraint 28
 for dependency 83
 for extend 93
 for flow relationship 59
 for include 93
 for instance of 87
 for object flow 157
 for realization 47
 for return 106
 solid
 for call 105
 for generalization 80
 for message 105
 for navigation 67
 for sending signal 105
 for transition 140
association 61, 64
association (keyword) 78
association class 62, 71, 72
association end 62, 65, 68
association name 62, 64
association role 109, 119
attribute 36, 37, 39, 40
 in object 58

3 UML Notation

B

- bar
 - for stub state 147
 - for stubbed transition 143
 - for synchronization, fork, join 141
- become (keyword) 59
- behavior
 - of operation as note 44
- binary association 61
- bind (keyword) 84
- binding 51, 51
- boldface
 - for class name 35
 - for compartment name 38
 - for special list element 35
- Boolean property 30
- bound element 51, 51
- braces
 - for constraint 27, 28
 - for property string 29, 37, 40
- branch 100, 152, 154, 155
- branch point 145
- bull's eye
 - for final state 135

C

- call 102
- call event 138
- chain of transitions 145
- changeability 67
- circle
 - bull's eye
 - for final state 135
 - filled
 - for initial state 135
 - for history state 143
 - for interface 48
 - for junction 145
 - for synch state 149
- class 34, 36
 - declared in another class 75
- class diagram 33
- class in state 58
- class scope 36
 - attribute 41
 - operation 43
- classifier 34
- classifier role 109, 119
- collaboration 109, 111, 116
 - specialization 115
- collaboration diagram 109, 111, 113, 113, 114
- collaboration role 118
- collaboration use 115
- colon
 - for return type 43
 - for sequence expression 125
 - for type 40, 43, 50, 55, 58, 66, 75, 119, 169, 171

- comment 27, 28
- communication association 92, 94
- compartment 37
 - name 38, 39
 - special 35
- complete (keyword) 80
- complex transition 141, 142
- component 166, 170, 172
 - on node 170
- component diagram 165, 166
- composite object 60, 61
- composite state 135, 149
- composition 60, 61, 74, 77
- concurrency
 - of operation 44
- concurrent lifelines 103
- concurrent substate 135
- concurrent substates 137
- concurrent thread 123
- concurrent transition 142
- condition event 138
- conditional fork 163
- conditional, *See* branch
- constant
 - enumeration 54
- constraint 27, 28, 87
 - as list element 27
- constraint language 27
- context 111
- control flow icon 124
- control flow type 128
- control icons 159
- copy (keyword) 59
- creation 100, 103, 112, 128
- cross
 - for destruction 103
- cube
 - for node 169

D

- decision, *See* branch
- decomposition indicator icon 136
- defer (keyword) 160
- deferred event 160, 161
- dependency 83, 85
 - package 85
 - subsystem 21
- deployment diagram 166, 168
- derivation 84
- derive (keyword) 84
- derived element 86, 87
- design pattern 114
- destination state 141
- destroyed (keyword) 112
- destruction 100, 103, 112, 128

diamond
 filled
 for composition 74
 for aggregation 66
 for branch or merge 155
 for merge 145
 for n-ary association 73
discriminator 80, 82
disjoint (keyword) 80
disjoint generalization 82
disjoint substate 135
do activity 133
dog-eared rectangle
 for note 14
dot
 for navigation 13
 for sequence expression 125
double colon
 for pathname 35, 55
double dot
 for integer range 69
dynamic choice point 145, 146
dynamic concurrency 162

E

elapsed-time event 138
element property 29
ellipse
 dashed
 for collaboration 115
 for use case 91
ellipsis
 for generalization 80, 83
 for missing element 37
else (keyword) 146
entry action 133
entry stub state 147
enumeration 54
enumeration literal 54
equal sign
 for attribute value 58
 for default value 43, 50
 for initial value 40
 for tagged value 30
event 137
event signature 140
examples section 5
exit action 133
exit stub state 147
expression 12
extend 92, 93
extensibility mechanism 29, 31
extension mechanisms 27
extension point 91
extension points compartment 91

F

facade (stereotype) 17

factored transition path 145
feature 37
final state 135
flow relationship 59
focus of control 100, 102, 104
font usage 9
fork of control 141
framework (stereotype) 17
frozen (keyword) 41, 67

G

generalization 79, 81, 82
 association 80
 constraints on 80
 use case 92
global (keyword) 79
graphic constructs 7
graphic marker 31
group property 38
guard condition 140
guillemets
 for keyword 12
 for stereotype 31, 37

H

hidden element 37
history indicator 144
history state 143
hyperlink 8

I

icon
 for stereotype 31, 32, 37
icons 7
implementation class 47
 and type 46
implementation diagram 165
import 18, 56, 84
imported element 17
importing a package 56
include 93, 133
 a use case 92
include (keyword) 147
incomplete (keyword) 80
incomplete generalization 82
initial state 135
initial value
 of attribute 41
input event icon 159
instance 15, 87
 of classifier 87
instance level collaboration 112, 114
instantiable subsystem 20
interaction 110, 117
interaction diagram 97, 109
interface 22, 23, 48, 49
 on subsystem 21

3 UML Notation

interface specifier 66
internal transition compartment 133
invisible hyperlink 8
italics
 for abstract class 37
 for abstract operation 44
iteration indicator 126

J

join of control 141
junction 145
junction point 146

K

keyword 12

L

label 11
lifeline 98, 99, 100, 103
line 62
 dashed
 for association class 71
 for lifeline 103
 solid
 for actor-use case 93
 for association 62
 for association class 71
 for communication association 94
link 78, 79, 113
list compartment 37, 39
literal
 of enumeration type 54
local (keyword) 79

M

many 69
mapping section 6
merge 155
message 99, 105, 113, 124
message label 125
message name 126
Message Sequence Chart notation 98
metaclass 53
method 45
minus sign
 for private visibility 40
model 24, 25
model management 17
model organization 17
model tree 25
multiobject 121, 122

multiplicity 68
 of association 68
 of association end 65
 of attribute 41
 of qualified association 70
 on dynamic concurrency 162

N

name 10
name compartment 36, 37, 133
named compartment 38, 39
n-ary association 73
navigability 66
navigation arrow 67
nested state 135
nesting
 for composition 75, 77
new (keyword) 112
node 168, 168, 170
notation section 5
note 14, 28

O

object 58, 60, 99, 100, 118, 157
 lifeline 103
 playing role 119
object diagram 34
object flow 157, 158
object in state 157
Object Message Sequence Chart notation 98
object name syntax 120
object role 113
OCL 27
OCL expression 13
operation 36, 37, 39, 42, 45
ordered (keyword) 65
ordering 65
output event icon 159
overlapping (keyword) 80, 82

P

package 17, 18, 57
package tree 19
parameter (keyword) 78
parameter list 43
parameterized class 49
parentheses
 for argument list 13
 for parameter list 43, 134, 140
participation (in a use case) 92, 94
path 8, 55
 for association 62
path (symbol) 7, 8
pathname 55, 56
pattern 114, 115

pentagon
 for signal receipt 159
 for signal sending 159
plus sign
 for containment tree 17
 for public visibility 40
pound sign
 for protected visibility 40
powertype 55
predecessor 103, 125
presentation options 5, 8
private (keyword) 40
procedural sequence diagram 102
pronged rectangle
 for component 171
property 29
property string 30, 38
protected (keyword) 40
public (keyword) 40

Q

qualified association 71
qualifier 66, 70, 71
query 43

R

range 69
realization 22, 23, 49, 116
 of interface by classifier 48
realization element 20, 23
realization relationship 47
rectangle
 dashed
 for template parameters 50
 dog-eared
 for note 14
 pronged
 for component 171
 rounded ends
 for action state 153
 for state 133
 for subactivity state 154
 solid
 for active class 122
 for association class 71
 for class 34
 for object 58
 for qualifier 70
 stacked
 for multiobject 121
 tabbed
 for package 17
 thin
 for activation lifeline 104
recurrence 126
recursion 100
reference to another package 35
refine (keyword) 84

refinement 84
return type expression 43
return value 126
right arrow
 for special operation 13
role 15
role name syntax 120
rolename 64, 66

S

self (keyword) 79
semantics section 5
sequence diagram 97, 98, 99, 100, 101
sequence expression 125
sequence number 111, 113, 125
sequential substate 135, 136
signal 138
 declaration 138, 139
 signal receipt icon 159, 160
 signal sending icon 159, 160
 signature 126
 simple transition 140
slash
 for action expression 133, 140
 for derived element 86
 for predecessor 125
 for role 119
sorted (keyword) 65
source state 141
specification element 20, 22, 23
specification level collaboration 112, 113
square brackets
 for attribute multiplicity 40, 41
 for condition clause 126
 for guard condition 134, 140
 for selection 13
 for state 58, 157
star
 for iteration indicator 126
 for multiplicity 69
 for synchronization bound 149
state 132, 134
 composite 149
 of object 58
state diagram 132
statechart diagram 131
static structure diagrams 33
stereotype 30, 32, 54
 as list element 39
 class 36
 object 58
stick arrowhead
 for control flow 105
stick man figure
 for use case 92
stimulus 105, 124
string 7, 9, 11
stub (stereotype) 17
stub state 147

3 UML Notation

stubbed transition 143, 144
style guidelines 5
subactivity state 154, 154
submachine invocation 133
submachine state 147, 148
substate 135
subsystem 19, 20, 21, 22, 23
 tree 25
support (keyword) 169
suppressed element 37
swimlane 155, 156
synch state 149, 149, 162, 162
synchronization 149
synchronization bar 141, 152
system boundary 89
systemModel (stereotype) 24, 25

T

tabbed rectangle
 for package 17
tagged value 29
taxonomic relationship 79
template 49, 51
tiling (a state) 135
time dimension 98
time event 138
time expression 107, 140
time interval 98, 99
timing constraint 98, 99, 107
tools, interactive 8
topLevel (stereotype) 17
trace (keyword) 84
transient (keyword) 112
transition 140
 chain 145
 complex 141, 142
 constraint 140
 name 107
 simple 140
 string 140
 stubbed 143
 time 107
 to composite state 142

triangle
 for generalization 80
 for realization 47
two-dimensional symbols 7
type 47
 and implementation class 46
type expression 41
type-instance correspondence 15

U

underlining
 for class scope 41, 43
 for instances 15
 for object 58, 119
unlimited multiplicity 69
unordered (keyword) 65
usage dependency 49, 84
use (keyword) 49, 84
use case 90, 91, 93
use case diagram 89, 90
use case relationship 92, 93
utility (keyword) 53, 53

V

visibility
 of association 67
 of attribute 40
 of operation 43
 of package element 17

W

when (keyword) 138

X

X
 for destruction 103
xor association 63, 64

This chapter includes the *UML Profile for Software Development Processes* and *UML Profile for Business Modeling*.

Contents

Part 1 - UML Profile for Software Development Processes	4-3
4.1 Overview	4-3
4.2 Introduction	4-3
4.3 Summary of Profile	4-3
4.4 Stereotypes and Notation	4-5
4.5 Well-Formedness Rules	4-8
Part 2 - UML Profile for Business Modeling	4-9
4.6 Introduction	4-9
4.7 Summary of Profile	4-9
4.8 Stereotypes and Notation	4-10
4.9 Well-Formedness Rules	4-13

4 UML Standard Profiles

Part 1 - UML Profile for Software Development Processes

4.1 Overview

UML is broadly applicable without extension, so extensions should be considered only as a last resort. Extensions will not be universally understood, supported, and agreed upon. Instead, UML profiles provide a standard way to use UML in a particular area without having to extend or modify UML.

A *UML Profile* is a predefined set of Stereotypes, TaggedValues, Constraints, and notation icons that collectively specialize and tailor the UML for a specific domain or process (e.g., Unified Process profile). A profile does not extend UML by adding any new basic concepts. Instead, it provides conventions for applying and specializing standard UML to a particular environment or domain.

User-defined profiles of the UML are enabled through the use of stereotypes, tagged values, and constraints. Two profiles are defined currently: 1) Unified Process and 2) Business Modeling.

4.2 Introduction

This section defines the UML Profile for the Unified Process for software engineering, defined in terms of the UML's extensibility mechanisms, namely Stereotypes, TaggedValues, and Constraints.

See the UML Semantics chapter for a full description of the UML extensibility mechanisms.

This chapter is not meant to be a complete definition of the Unified Process and how to apply it, but it serves the purpose of defining this profile, including its icons.

4.3 Summary of Profile

Table Table 4-1 lists the stereotypes defined by this profile.

4 UML Standard Profiles

Table 4-1 Stereotypes

Metamodel Class	Stereotype Name
Model	use-case model
Model	analysis model
Model	design model
Model	implementation model
Package	use-case system
Package	analysis system
Subsystem	design system
Subsystem	implementation system
Package	analysis package
Subsystem	design subsystem
Subsystem	implementation subsystem
Package	use-case package
Package	analysis service package
Subsystem	design service subsystem
Class	boundary
Class	entity
Class	control
Association	communicate
Association	subscribe
Collaboration	use-case realization

4.3.1 TaggedValues

Currently, this profile does not introduce any new TaggedValues.

4.3.2 Constraints

Currently, this profile does not introduce any new Constraints, other than those associated with the well-formedness semantics of the stereotypes introduced.

4.3.3 Prerequisite Profiles

This profile requires no other profiles to the UML for its definition.

4.4 Stereotypes and Notation

4.4.1 Model, Package, and Subsystem Stereotypes

A system modeled by the Unified Process comprises several different, but related models. These models are characterized by the lifecycle stage that they represent. Each model makes use of one specific stereotype. The different models are:

- Use Case
- Analysis
- Design
- Implementation

Use Case

A Use Case Model specifies the services a system provides to its users, i.e. the different ways of using the system.

A Use Case System is a top-level package. A use case system contains use case packages and/or use cases and relationships.

A Use Case Package is a package containing use cases and relationships. A use case is not partitioned over several use case packages.

Analysis

An Analysis Model is a model whose top-level package is an analysis system.

An Analysis System is a top-level package. An analysis system contains analysis packages, and/or analysis service packages, and/or analysis classes (i.e., entity, boundary, and control), and relationships.

An Analysis Package is a package containing other analysis packages, analysis service packages, analysis classes (i.e., entity, boundary, and control), and relationships.

An Analysis Service Package is a package containing analysis classes (i.e., entity, boundary, and control) and relationships.

Design

A Design Model is a model whose top-level package is a design system.

A Design System is a top-level subsystem. A design system contains design subsystems, and/or design service subsystems, and/or design classes, and relationships.

A Design Subsystem is a subsystem containing other design subsystems, design service subsystems, design classes, and relationships.

A Design Service Subsystem is a subsystem containing design classes and relationships.

4 UML Standard Profiles

Implementation

An Implementation Model is a model whose top-level package is an implementation system.

An Implementation System is a top-level subsystem. An implementation system contains implementation subsystems, and/or components, and relationships.

An Implementation Subsystem is a subsystem containing implementation subsystems, and/or components, and relationships.

Notation

Package, subsystem, and model stereotypes are indicated with stereotype keywords in guillemets («stereotype name»). There are no special icons for these stereotypes, but the icon for a model or a subsystem may be used in the upper right of the package symbol in conjunction with the stereotype keyword for stereotypes of the corresponding kind. Use of these icons is not mandatory, because the stereotype keyword is unambiguous.

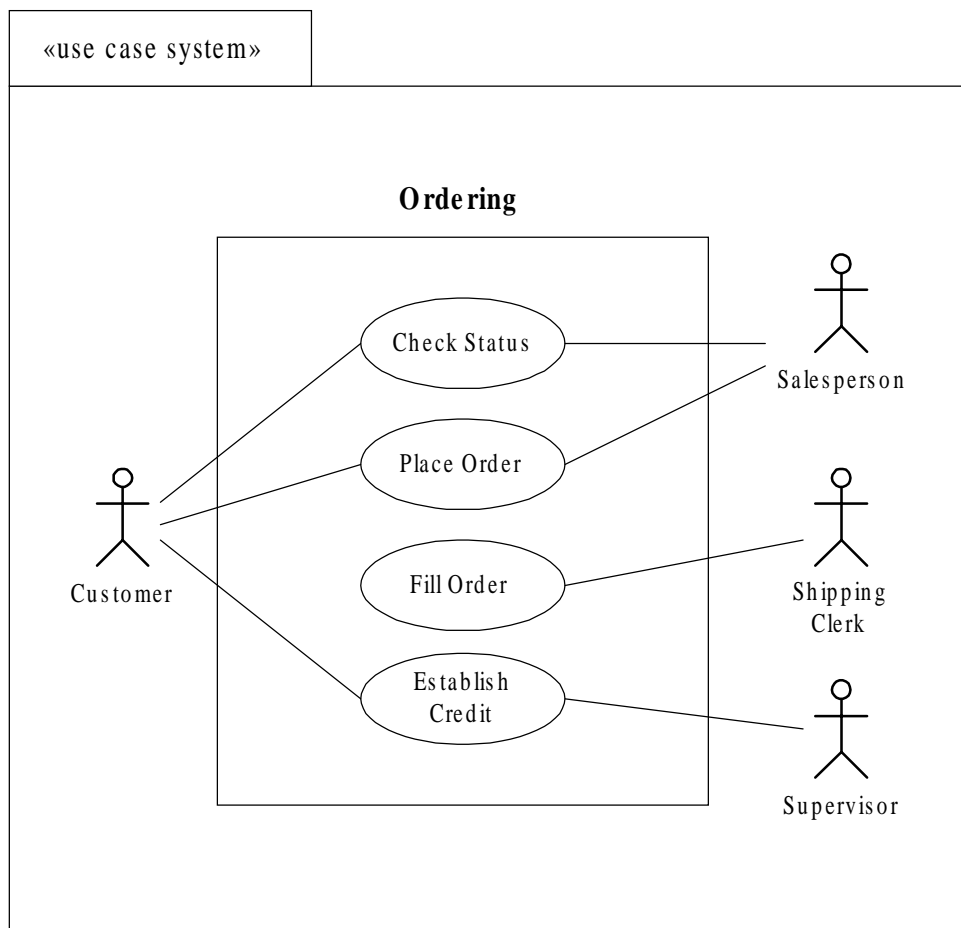

Figure 4-1 Packages in the Unified Process

4.4.2 Class Stereotypes

Analysis classes come in the following three kinds: 1) entity, 2) control, and 3) boundary. Design classes are not by default stereotyped in the Unified Process.

Entity

An Entity is a class that is passive; that is, its objects do not initiate interactions on their own. An entity object may participate in many different use case realizations and usually outlives any single interaction.

Control

A Control is a class, whose objects control interactions between collections of objects. A control class usually has behavior specific for one use case and a control object usually does not outlive the use case realizations in which it participates.

Boundary

A Boundary is a class that lies on the periphery of a system, but within it. It interacts with actors outside the system as well as objects of all three kinds of analysis classes within the system.

Notation

Class stereotypes can be shown with keywords in guillemets. They can also be shown with the following special icons.

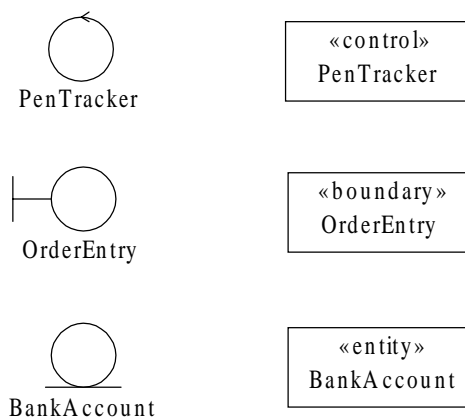

Figure 4-2 Class Stereotypes

4.4.3 Association Stereotypes

The following are special Unified Process associations between classes.

4 UML Standard Profiles

Communicate

Communicate is an association between actors and use cases denoting that the actor sends messages to the use case and/or the use case sends messages to the actor. It may also be used between boundary, control, and entity, and between actor and boundary. The communication may be one-way or two-way navigation. The direction of communication is indicated by the navigability of the association.

Subscribe

A subscribe association between two classes states that objects of the source class (called the subscriber) will be notified when a particular event has occurred in objects of the target class (called the publisher). The association includes a specification of a set of event defining the events that causes the subscriber to be notified.

Notation

Association stereotypes are indicated by keywords in guillemets. There are no special stereotype icons. The stereotype «communicate» on actor-use case associations may be omitted, since it is the only kind of relationships between actors and use cases.

4.5 Well-Formedness Rules

Stereotyped model elements are subject to certain constraints, in addition to the constraints imposed on all elements of their kind.

4.5.1 Generalization

All the modeling elements in a generalization must be of the same stereotype.

4.5.2 Association

Apart from standard UML combinations, the combinations of stereotypes shown in Table 4-2 may also be used.

Table 4-2 Valid Association Stereotype Combinations

From:	To:	actor	boundary	entity	control
actor			communicate		
boundary		communicate	communicate	communicate subscribe	communicate
entity				communicate subscribe	
control			communicate	communicate subscribe	communicate

4.5.3 Model, Package, and Subsystem Containment

A model being stereotyped use case, analysis, design, or implementation may not contain elements that are stereotyped with one of the other three stereotypes. For example, a use-case model may not contain analysis subsystems.

Part 2 - UML Profile for Business Modeling

4.6 Introduction

The UML Profile for Business Modeling is defined in terms of the UML’s extensibility mechanisms, namely Stereotypes, TaggedValues, and Constraints. See the UML Semantics chapter for a full description of the UML extensibility mechanisms.

This section describes stereotypes that can be used to tailor the use of UML for business modeling. All of the UML concepts can be used for business modeling, but providing business stereotypes for some common situations provides a common terminology for this domain. Note that UML can be used to model different kinds of systems (software systems, hardware systems, and real-world organizations). Business modeling models real-world organizations.

This section is not meant to be a complete definition of business modeling concepts and how to apply them, but it serves the purpose of defining this profile, including its icons.

4.7 Summary of Profile

Stereotypes for this profile are shown in Table 4-3.

Table 4-3 Metamodel Class Stereotypes

Metamodel Class	Stereotype Name
Model	use-case model
Package	use-case system
Package	use-case package
Model	object model
Subsystem	object system
Subsystem	organization unit
Subsystem	work unit
Class	worker
Class	case worker
Class	internal worker
Class	entity
Collaboration	use-case realization
Association	subscribe

4 UML Standard Profiles

4.7.1 Tagged Values

This profile does not currently introduce any new TaggedValues.

4.7.2 Constraints

This profile does not currently introduce any new Constraints, other than those associated with the well-formedness semantics of the stereotypes introduced.

4.7.3 Prerequisite Profiles

This profile requires no other profiles to the UML for its definition.

4.8 Stereotypes and Notation

4.8.1 Model, Package, and Subsystem Stereotypes

A business system comprises several different, but related, models. The models are characterized by being exterior or interior to the business system they represent. Exterior models are use case models and interior models are object models. A large business system may be partitioned into subordinate business systems. The following are the model stereotypes.

Use Case

A Use Case Model is a model that describes the business processes of a business and their interactions with external parties such as customers and partners.

A use case model describes:

- the businesses modeled as use cases.
- parties exterior to the business (e.g., customers and other businesses) modeled as actors.
- the relationships between the external parties and the business processes.

A Use Case System is the top-level package in a use case model. A use case system contains use case packages, use cases, and relationships.

A Use Case Package is a package containing use cases and relationships. A use case is not partitioned over several use case packages.

Object

An Object Model is a model in which the top-level package is an object system. These models describe the things interior to the business system itself.

An Object System is the top-level subsystem in an object model. An object system contains organization units, classes (workers, work units, and entities), and relationships.

Organization Unit

Organization Unit is a subsystem corresponding to an organization unit of the actual business. An organization unit subsystem contains organization units, work units, classes (workers and entities), and relationships.

Work Unit

A Work Unit is a subsystem that contains one or more entities.

A work unit is a task-oriented set of objects that form a recognizable whole to the end user. It may have a facade defining the view of the work unit's entities relevant to the task.

Notation

Package stereotypes are indicated with stereotype keywords in guillemets («stereotype name»). There are no special icons for these stereotypes, but the icon for a model or a subsystem may be used in the upper right of the package symbol in conjunction with the stereotype keyword for stereotypes of the corresponding kind. Use of these icons is not mandatory, because the stereotype keyword is unambiguous.

4.8.2 *Class Stereotypes*

Business objects come in the following kinds:

- Actor (defined in the UML)
- Worker
- Case Worker
- Internal Worker
- Entity

Worker

A Worker is a class that represents an abstraction of a human that acts within the system. A worker interacts with other workers and manipulates entities while participating in use case realizations.

Case Worker

A Case Worker is a worker who interacts directly with actors outside the system.

Internal Worker

An Internal Worker is a worker that interacts with other workers and entities inside the system.

4 UML Standard Profiles

Entity

An Entity is a class that is passive; that is, it does not initiate interactions on its own. An entity object may participate in many different use case realizations and usually outlives any single interaction. In business modeling, entities represent objects that workers access, inspect, manipulate, produce, and so on. Entity objects provide the basis for sharing among workers participating in different use case realizations.

Notation

Class stereotypes can be shown with keywords in guillemets within the normal class symbol. They can also be shown with the following special icons.

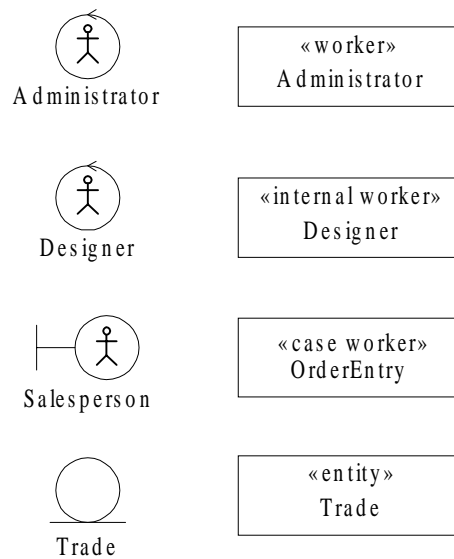

Figure 4-3 Class Stereotypes

The preceding icons represent common concepts useful in most business models.

Example of Alternate Notations

Tools and users are free to add additional icons to represent more specific concepts. Examples of such icons include icons for documents and actions, as shown in Figure 4-4.

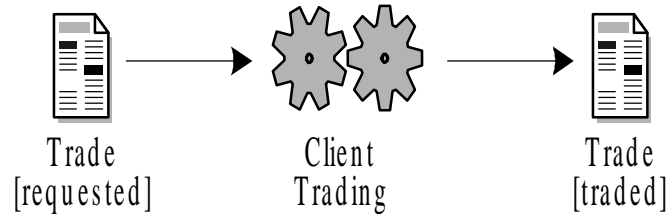

Figure 4-4 Example of Special Icons for Entities and Actions

In this example, "Trade [requested]" and "Trade [traded]" represent an entity in two states, where the Trade is the dominant entity of a Trade Document work unit. Client Trading is an action. The icons are designed to be meaningful in the particular problem domain.

4.8.3 Association Stereotypes

The following are special business modeling associations between classes:

Communicate

Communicate is an association used for defining that instances of the associated classifiers interact. This may be one-way or two-way navigation. The direction of communication is the same as the navigability of the association.

Subscribe

A subscribe association between two classes states that objects of the source class (called the subscriber) will be notified when a particular event has occurred in objects of the target class (called the publisher). The association includes a specification of a set of event defining the events that causes the subscriber to be notified.

Notation

Association stereotypes are indicated by keywords in guillemets. There are no special stereotype icons.

4.9 Well-Formedness Rules

Stereotyped model elements are subject to certain constraints in addition to the constraints imposed on all elements of their kind.

4 UML Standard Profiles

4.9.1 Generalization

All the modeling elements in a generalization must be of the same stereotype.

4.9.2 Association

Apart from standard UML combinations, the combinations of stereotypes shown in Table 4-4 may also be used.

Table 4-4 Valid Association Stereotype Combinations

From:	To:	actor	case worker	entity	work unit	internal worker
actor			communicate		communicate subscribe	
case worker	communicate	communicate	communicate	communicate subscribe	communicate subscribe	communicate
entity				communicate subscribe	communicate	
work unit	communicate	communicate	communicate	communicate subscribe	communicate subscribe	communicate
internal worker			communicate	communicate subscribe	communicate subscribe	communicate

UML CORBAfacility Interface Definition 5

This chapter specifies the interfaces for a CORBAfacility for the Unified Modeling Language, version 1.3. The UML CORBAfacility (or UML Facility for short) is a repository for models expressed in the UML. The facility enables the creation, storage, and manipulation of UML models. The facility enables clients to be developed that provide a wide variety of model-based development capabilities, including:

- Drawing and animation of UML models in UML and other notations
- Enforcement of process and method style guidelines
- Metrics, queries, and reports
- Automation of certain development lifecycle activities (e.g., through design wizards and code generation).

Contents

5.1 Overview	5-3
5.2 Mapping of UML Semantics to Facility Interfaces	5-4
5.3 Facility Implementation Requirements	5-6
5.4 IDL Modules	5-7

5 UML CORBAfacility Interface Definition

5.1 Overview

There are two sets of interfaces provided: 1) generic and 2) tailored. Both sets of interfaces enable the creation and traversal of UML model elements.

The generic interfaces are included in the Reflective module. This is a set of general-purpose interfaces that provide utility for browser type functionality and as a base for the tailored interfaces. They are more fully described in the Meta-Object Facility (MOF) Specification.

A set of tailored interfaces that are specifically typed to the UML metamodel elements is defined. The tailored interfaces inherit from the generic interfaces. The tailored interfaces provide capabilities necessary to instantiate, traverse, and modify UML model elements in the facility, directly in terms of the UML metamodel, with type safety. The specifications of the tailored interfaces were generated by applying a set of transformations to the UML semantic metamodel. Because the tailored interfaces were generated consistently from a set of patterns (described more fully in the MOF Specification), they are easy to understand and program against. It is feasible to generate automatically the implementation for the UML Facility, for the most part, because of these patterns and because the UML metamodel is strictly structural.

The UML is designed with a layered architecture. Implementors can choose which layers to implement, and whether to implement only the generic interfaces or the generic and tailored interfaces.

One of the primary goals was to advance the state of the industry by enabling OO modeling tool interoperability. This UML Facility defines a set of interfaces to provide that tool interoperability. However, enabling meaningful exchange of model information between tools requires agreement on semantics and their visualization. The metamodel documenting the UML semantics is defined in the UML Semantics chapter. Most of the IDL defined in this document is a direct mapping of the UML version 1.3 metamodel, based on the IDL mapping defined in the MOF specification. Because the UML semantics are sufficiently complex, they are documented separately in the UML Semantics chapter, whereas this chapter is void of explanations of semantics.

5.1.1 Tool Sharing Options

A major goal is to achieve semantic interoperability between UML tools. Three options are explained below: model transfer, a general-purpose repository, and a UML facility.

Model Transfer

Two tools could understand the same stream format and exchange models via that stream, which could be a file. This is referred to as an “import facility.” A stream interface provides a sharing between tools that are not implemented in an API (CORBA or non-CORBA) or repository environment. XML Metadata Interchange (XMI) is an example of a stream format.

5 UML CORBA facility Interface Definition

General-purpose Repository

Two tools could interface to the same repository and access a model there. A MetaObject Facility (MOF) could provide this repository. The MOF Specification defines a generic interface to repository objects.

UML Facility

Two tools could exchange models on a detail-by-detail basis. This is referred to as a “connection facility.” Although this would not be the most efficient method for sharing an entire model, this type of access enables semantic interoperability to the greatest degree and is extremely useful for client applications. This is also a repository, but its interfaces are specific to UML tools. A set of IDL interfaces is defined in this document to provide model access.

In summary, the UML Facility defines IDL interfaces for clients to use for model access.

5.2 Mapping of UML Semantics to Facility Interfaces

Understanding the process used to generate the IDL for this facility is helpful in understanding the resulting IDL. The process was as follows:

1. Converted the UML Semantics Metamodel into an interface metamodel, making necessary refinements for CORBA interfaces.
2. Put the interface metamodel into a MetaObject Facility as a MOF Package.
3. Generated IDL from the MOF, based on the mapping defined in the MOF Specification.

5.2.1 Transformation of UML Semantics Metamodel into Interfaces Metamodel

A model was created representing the interfaces required on the UML Facility. This interface metamodel is nearly identical to the UML Semantics metamodel, so it is not documented explicitly. The following list summarizes the conversions made from the UML Semantics metamodel:

- Mapped all UML data types and select classes to CORBA data types. Put all CORBA data types in Foundation where they are visible to Core. The data types appear at the beginning of the Foundation module below.
- Named associations and their ends, where names were missing. The name given to each unnamed AssociationEnd is its type’s name with the first letter downcased. The name given to each unnamed Association is “A” followed by the first end’s name with the first letter upcased followed by the second end’s name with the first letter upcased.
- Prefixed the names of certain classifiers, association ends, and attributes with “Uml” to avoid conflicts with words reserved in Reflective interfaces, CORBA, and MOF.
- Deleted derived associations, since they would have resulted in redundant interfaces.
- Transformed association classes into more fundamental structures. The transformation is explained below.

5.2 Mapping of UML Semantics to Facility Interfaces

- For each navigable AssociationEnd, created a Reference in the Class that is the end's type if the Class's owning Package is the same as the Association's owning Package. Named the Reference the same as the AssociationEnd.
- Appended numbers to names as needed to avoid name duplication errors.
- Renamed enumeration literal names so they would be unique within the resulting IDL modules.

The IDL generation from the MOF assures that all classes in the interface metamodel are specializations of `Reflective::RefObject`, so this relationship is assumed to be present in the interface metamodel.

Transformation for Association Classes

Since the MOF does not represent the semantics of association classes directly, we needed to convert Each Association Class into something else. In the case of `ElementOwnership`, which is single-valued on one end, we moved the attributes into the other end, `ModelElement`. We converted every other Association Class into a simple class and added necessary relationships to enable complete navigation (in the resulting facility IDL). Figure 5-1 shows an example Association Class as it would appear in the semantic metamodel.

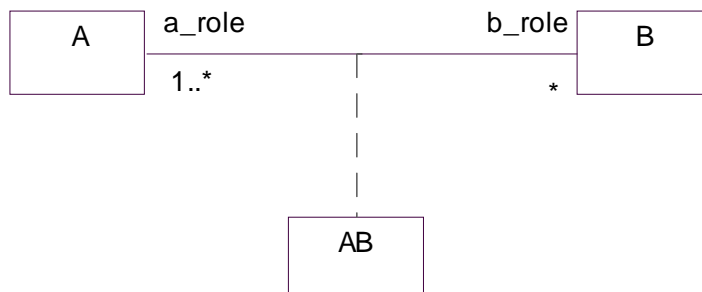

Figure 5-1 An Association Class in a Semantic metamodel

Figure 5-2 shows the corresponding transformed structure in the interface model.

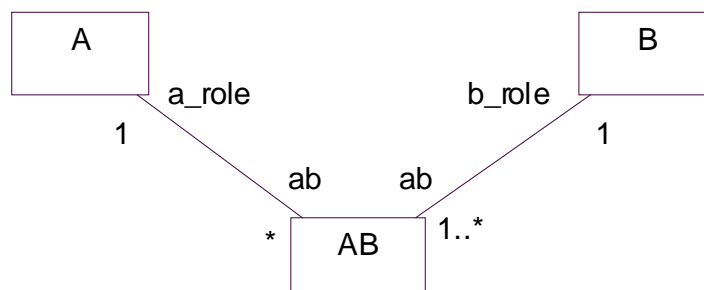

Figure 5-2 Corresponding Association Class in an interface metamodel

5 UML CORBAfacility InterfaceDefinition

5.2.2 Mapping from MOF to IDL

The description for the mapping from instances of models stored in the MOF is described in detail in the MOF Specification. The result of this mapping is the generated IDL in this specification.

5.2.3 MOF Generic Interfaces

The MOF Specification fully describes the generic interfaces. As a summary, the generic interfaces in the Reflective module provide the following:

- consistent treatment of type information,
- exception handling (including constraint violations, missing parameters, etc.), and
- generic creation and traversal of objects.

Note – The MOF Specification replaces the definition of the Reflective module contained in this specification.

5.3 Facility Implementation Requirements

Although this chapter focuses on defining the interfaces for the facility and leaves implementation decisions up to the creativity of vendors, there are some implementation requirements.

The UML Standard Elements (stereotypes, constraints, and tags) must be known to a facility implementation, or provided via a load. This is necessary so that the interoperability of these elements can be achieved. The semantics of the standard elements (e.g., containment restrictions) must be enforced. The Standard Elements are documented in the UML Semantics chapter.

5.4 IDL Modules

5.4.1 Reflective

```

#ifndef REFLECTIVE_IDL
#define REFLECTIVE_IDL
#pragma prefix "org.omg.Uml"

module Reflective
{
  interface RefBaseObject;
  interface RefObject;
  typedef sequence<RefObject> RefObjectUList;
  typedef sequence<RefObject> RefObjectSet;
  interface RefAssociation;
  interface RefPackage;
  typedef RefObject DesignatorType;
  typedef any ValueType;
  typedef sequence<ValueType> ValueTypeList;
  typedef sequence<RefObject, 2> Link;
  typedef sequence<Link> LinkSet;

  // MOF error kinds
  const string UNDERFLOW_VIOLATION = "org.omg.mof:structural.underflow";
  const string OVERFLOW_VIOLATION = "org.omg.mof:structural.overflow";
  const string DUPLICATE_VIOLATION = "org.omg.mof:structural.duplicate";
  const string REFERENCE_CLOSURE_VIOLATION =
    "org.omg.mof:structural.reference_closure";
  const string SUPERTYPE_CLOSURE_VIOLATION =
    "org.omg.mof:structural.supertype_closure";
  const string COMPOSITION_CYCLE_VIOLATION =
    "org.omg.mof:structural.composition_cycle";
  const string COMPOSITION_CLOSURE_VIOLATION =
    "org.omg.mof:structural.composition_closure";
  const string INVALID_OBJECT_VIOLATION = "org.omg.mof:structural.invalid_object";
  const string ALREADY_EXISTS_VIOLATION = "org.omg.mof:structural.already_exists";
  const string INVALID_DESIGNATOR_VIOLATION =
    "org.omg.mof:reflective.invalid_designator";
  const string WRONG_DESIGNATOR_DESIGNATOR_VIOLATION =
    "org.omg.mof:reflective.wrong_designator_kind";
  const string UNKNOWN_DESIGNATOR_VIOLATION =
    "org.omg.mof:reflective.unknown_designator";
  const string ABSTRACT_CLASS_VIOLATION = "org.omg.mof:reflective.abstract_class";
  const string NOT_CHANGEABLE_VIOLATION = "org.omg.mof:reflective.not_changeable";
  const string NOT_PUBLIC_VIOLATION = "org.omg.mof:reflective.not_public";
  const string WRONG_SCOPE_VIOLATION = "org.omg.mof:reflective.wrong_scope";
}

```

5 UML CORBAfacility InterfaceDefinition

```
const string WRONG_MULTPLICITY_VIOLATION =
    "org.omg.mof:reflective.wrong_multiplicity";
const string WRONG_TYPE_VIOLATION = "org.omg.mof:reflective.wrong_type";
const string WRONG_NUMBER_PARAMETERS_VIOLATION =
    "org.omg.mof:reflective.wrong_number_parameters";
const string INVALID_DELETION_VIOLATION = "org.omg.mof:reflective.invalid_deletion";

struct NamedValueType
{
    string name;
    ValueType value;
};
typedef sequence<NamedValueType> NamedValueList;

exception MofError
{
    string error_kind;
    RefBaseObject object_in_error;
    NamedValueList extra_info;
    string error_description;
};
exception NotFound {};
exception NotSet {};
exception BadPosition
{
    unsigned long current_size;
};
exception OtherError
{
    DesignatorType exception_designator;
    ValueTypeList exception_values;
};

interface RefBaseObject
{
    string ref_mof_id ();
    DesignatorType ref_meta_object ();
    boolean ref_itself (in RefBaseObject other_object);
    RefPackage ref_immediate_package ();
    RefPackage ref_outermost_package ();
    void ref_delete () raises (MofError);
}; // end of interface RefBaseObject

interface RefObject : RefBaseObject
{
    boolean ref_is_instance_of (
        in DesignatorType some_class,
        in boolean consider_subtypes)
        raises (MofError);
    RefObject ref_create_instance (in ValueTypeList args)
        raises (MofError);
};
```

```

RefObjectSet ref_all_objects (in boolean include_subtypes);
ValueType ref_value (in DesignatorType feature)
    raises (NotSet, MofError);
void ref_set_value (
    in DesignatorType feature,
    in ValueType new_value)
    raises (MofError);
void ref_unset_value (in DesignatorType feature)
    raises (MofError);
void ref_add_value (
    in DesignatorType feature,
    in ValueType new_element)
    raises (MofError);
void ref_add_value_before (
    in DesignatorType feature,
    in ValueType new_element,
    in ValueType before_element)
    raises (NotFound, MofError);
void ref_add_value_at (
    in DesignatorType feature,
    in ValueType new_element,
    in unsigned long position)
    raises (BadPosition, MofError);
void ref_modify_value (
    in DesignatorType feature,
    in ValueType old_element,
    in ValueType new_element)
    raises (NotFound, MofError);
void ref_modify_value_at (
    in DesignatorType feature,
    in ValueType new_element,
    in unsigned long position)
    raises (BadPosition, MofError);
void ref_remove_value (
    in DesignatorType feature,
    in ValueType old_element)
    raises (NotFound, MofError);
void ref_remove_value_at (
    in DesignatorType feature,
    in unsigned long position)
    raises (BadPosition, MofError);
RefObject ref_immediate_composite ();
RefObject ref_outermost_composite ();
ValueTypeList ref_invoke_operation (
    in DesignatorType requested_operation,
    inout ValueTypeList args)
    raises (OtherError, MofError);
}; // end of interface RefObject

interface RefAssociation : RefBaseObject
{

```

5 UML CORBAfacility InterfaceDefinition

```
LinkSet ref_all_links ();
boolean ref_link_exists (in Link some_link)
    raises (MofError);
RefObjectUList ref_query (
    in DesignatorType query_end,
    in RefObject query_object)
    raises (MofError);
void ref_add_link (in Link new_link)
    raises (MofError);
void ref_add_link_before (
    in Link new_link,
    in DesignatorType position_end,
    in RefObject before)
    raises (NotFound, MofError);
void ref_modify_link (
    in Link old_link,
    in DesignatorType position_end,
    in RefObject new_object)
    raises (NotFound, MofError);
void ref_remove_link (in Link old_link)
    raises (NotFound, MofError);
}; // end of interface RefAssociation

interface RefPackage : RefBaseObject
{
    RefObject ref_class_ref (in DesignatorType class)
        raises (MofError);
    RefAssociation ref_association_ref (in DesignatorType association)
        raises (MofError);
    RefPackage ref_package_ref (in DesignatorType package)
        raises (MofError);
}; // end of interface RefPackage

}; // end of module Reflective

#endif
```

5.4.2 Foundation

```

#pragma prefix "org.omg.Uml"
#include "Reflective.idl"

module Foundation
{
  interface FoundationPackage;

  module DataTypes
  {
    typedef long Integer;
    typedef long UnlimitedInteger; // -1 means infinity
    typedef float UmlTime;
    enum AggregationKind {ak_none, ak_aggregate, ak_composite};
    enum CallConcurrencyKind {cck_sequential, cck_guarded, cck_concurrent};
    enum ChangeableKind {ck_changeable, ck_frozen, ck_addOnly};
    enum MessageDirectionKind {mdk_activation, mdk_return};
    enum OperationDirectionKind {odk_provide, odk_require};
    enum OrderingKind {ok_unordered, ok_ordered, ok_sorted};
    enum ParameterDirectionKind {pdk_in, pdk_inout, pdk_out, pdk_return};
    enum PseudostateKind {pk_initial, pk_deepHistory, pk_shallowHistory, pk_join, pk_fork,
                          pk_branch, pk_junction, pk_final};

    enum ScopeKind {sk_classifier, sk_instance};
    enum VisibilityKind {vk_public, vk_private, vk_protected};
    typedef string Geometry;
    typedef string LocationReference;
    typedef string Mapping;
    struct MultiplicityRange {Integer lower; UnlimitedInteger upper;};
    typedef sequence<MultiplicityRange> Multiplicity;
    typedef string Name;
    struct Expression {Name language; string body;};
    typedef Expression ActionExpression;
    typedef Expression ArgListsExpression;
    typedef Expression BooleanExpression;
    typedef Expression IterationExpression;
    typedef Expression MappingExpression;
    typedef Expression ObjectSetExpression;
    typedef Expression ProcedureExpression;
    typedef Expression TimeExpression;
    typedef Expression TypeExpression;

    interface DataTypesPackage : Reflective::RefPackage
    {
    };
  }; // end of module DataTypes

  module Core
  {
    interface ClassifierClass;
  }
}

```

5 UML CORBAfacility InterfaceDefinition

```
interface Classifier;
typedef sequence<Classifier> ClassifierSet;
interface ClassClass;
interface Class;
typedef sequence<Class> ClassSet;
interface DataTypeClass;
interface DataType;
typedef sequence<DataType> DataTypeSet;
interface StructuralFeatureClass;
interface StructuralFeature;
typedef sequence<StructuralFeature> StructuralFeatureSet;
interface NamespaceClass;
interface Namespace;
typedef sequence<Namespace> NamespaceSet;
interface AssociationEndClass;
interface AssociationEnd;
typedef sequence<AssociationEnd> AssociationEndSet;
interface UmlInterfaceClass;
interface UmlInterface;
typedef sequence<UmlInterface> UmlInterfaceSet;
interface UmlConstraintClass;
interface UmlConstraint;
typedef sequence<UmlConstraint> UmlConstraintSet;
interface AssociationClass;
interface Association;
typedef sequence<Association> AssociationSet;
interface ElementClass;
interface Element;
typedef sequence<Element> ElementSet;
interface GeneralizableElementClass;
interface GeneralizableElement;
typedef sequence<GeneralizableElement> GeneralizableElementSet;
interface UmlAttributeClass;
interface UmlAttribute;
typedef sequence<UmlAttribute> UmlAttributeSet;
typedef sequence<UmlAttribute> UmlAttributeUList;
interface OperationClass;
interface Operation;
typedef sequence<Operation> OperationSet;
interface ParameterClass;
interface Parameter;
typedef sequence<Parameter> ParameterSet;
typedef sequence<Parameter> ParameterUList;
interface MethodClass;
interface Method;
typedef sequence<Method> MethodSet;
interface GeneralizationClass;
interface Generalization;
typedef sequence<Generalization> GeneralizationSet;
interface UmlAssociationClassClass;
interface UmlAssociationClass;
```

```
typedef sequence<UmlAssociationClass> UmlAssociationClassSet;
interface FeatureClass;
interface Feature;
typedef sequence<Feature> FeatureSet;
typedef sequence<Feature> FeatureUList;
interface BehavioralFeatureClass;
interface BehavioralFeature;
typedef sequence<BehavioralFeature> BehavioralFeatureSet;
interface ModelElementClass;
interface ModelElement;
typedef sequence<ModelElement> ModelElementSet;
typedef sequence<ModelElement> ModelElementUList;
interface DependencyClass;
interface Dependency;
typedef sequence<Dependency> DependencySet;
interface AbstractionClass;
interface Abstraction;
typedef sequence<Abstraction> AbstractionSet;
interface PresentationElementClass;
interface PresentationElement;
typedef sequence<PresentationElement> PresentationElementSet;
interface UsageClass;
interface Usage;
typedef sequence<Usage> UsageSet;
interface BindingClass;
interface Binding;
typedef sequence<Binding> BindingSet;
interface ComponentClass;
interface Component;
typedef sequence<Component> ComponentSet;
interface NodeClass;
interface Node;
typedef sequence<Node> NodeSet;
interface PermissionClass;
interface Permission;
typedef sequence<Permission> PermissionSet;
interface CommentClass;
interface Comment;
typedef sequence<Comment> CommentSet;
interface FlowClass;
interface Flow;
typedef sequence<Flow> FlowSet;
interface RelationshipClass;
interface Relationship;
typedef sequence<Relationship> RelationshipSet;
interface ElementResidenceClass;
interface ElementResidence;
typedef sequence<ElementResidence> ElementResidenceSet;
interface TemplateParameterClass;
interface TemplateParameter;
typedef sequence<TemplateParameter> TemplateParameterSet;
```

5 UML CORBAfacility InterfaceDefinition

```
typedef sequence<TemplateParameter> TemplateParameterUList;
interface CorePackage;

interface ElementClass : Reflective::RefObject
{
    readonly attribute ElementSet all_of_type_element;
};

interface Element : ElementClass
{
}; // end of interface Element

interface ModelElementClass : ElementClass
{
    readonly attribute ModelElementSet all_of_type_model_element;
};

interface ModelElement : ModelElementClass, Element
{
    DataTypes::Name name ()
        raises (Reflective::MofError);
    void set_name (in DataTypes::Name new_value)
        raises (Reflective::MofError);
    DataTypes::VisibilityKind visibility ()
        raises (Reflective::MofError);
    void set_visibility (in DataTypes::VisibilityKind new_value)
        raises (Reflective::MofError);
    boolean is_specification ()
        raises (Reflective::MofError);
    void set_is_specification (in boolean new_value)
        raises (Reflective::MofError);
    Core::Namespace namespace ()
        raises (Reflective::NotSet, Reflective::MofError);
    void set_namespace (in Core::Namespace new_value)
        raises (Reflective::MofError);
    void unset_namespace ()
        raises (Reflective::MofError);
    DependencySet client_dependency ()
        raises (Reflective::MofError);
    void set_client_dependency (in DependencySet new_value)
        raises (Reflective::MofError);
    void add_client_dependency (in Dependency new_element)
        raises (Reflective::MofError);
    void modify_client_dependency (
        in Dependency old_element,
        in Dependency new_element)
        raises (Reflective::NotFound, Reflective::MofError);
    void remove_client_dependency (in Dependency old_element)
        raises (Reflective::NotFound, Reflective::MofError);
    UmlConstraintSet uml_constraint ()
        raises (Reflective::MofError);
};
```



```
void set_uml_constraint (in UmlConstraintSet new_value)
    raises (Reflective::MofError);
void add_uml_constraint (in UmlConstraint new_element)
    raises (Reflective::MofError);
void modify_uml_constraint (
    in UmlConstraint old_element,
    in UmlConstraint new_element)
    raises (Reflective::NotFound, Reflective::MofError);
void remove_uml_constraint (in UmlConstraint old_element)
    raises (Reflective::NotFound, Reflective::MofError);
DependencySet supplier_dependency ()
    raises (Reflective::MofError);
void set_supplier_dependency (in DependencySet new_value)
    raises (Reflective::MofError);
void add_supplier_dependency (in Dependency new_element)
    raises (Reflective::MofError);
void modify_supplier_dependency (
    in Dependency old_element,
    in Dependency new_element)
    raises (Reflective::NotFound, Reflective::MofError);
void remove_supplier_dependency (in Dependency old_element)
    raises (Reflective::NotFound, Reflective::MofError);
PresentationElementSet presentation ()
    raises (Reflective::MofError);
void set_presentation (in PresentationElementSet new_value)
    raises (Reflective::MofError);
void add_presentation (in PresentationElement new_element)
    raises (Reflective::MofError);
void modify_presentation (
    in PresentationElement old_element,
    in PresentationElement new_element)
    raises (Reflective::NotFound, Reflective::MofError);
void remove_presentation (in PresentationElement old_element)
    raises (Reflective::NotFound, Reflective::MofError);
FlowSet target_flow ()
    raises (Reflective::MofError);
void set_target_flow (in FlowSet new_value)
    raises (Reflective::MofError);
void add_target_flow (in Flow new_element)
    raises (Reflective::MofError);
void modify_target_flow (
    in Flow old_element,
    in Flow new_element)
    raises (Reflective::NotFound, Reflective::MofError);
void remove_target_flow (in Flow old_element)
    raises (Reflective::NotFound, Reflective::MofError);
FlowSet source_flow ()
    raises (Reflective::MofError);
void set_source_flow (in FlowSet new_value)
    raises (Reflective::MofError);
void add_source_flow (in Flow new_element)
```

5 UML CORBAfacility InterfaceDefinition

```
    raises (Reflective::MofError);
void modify_source_flow (
    in Flow old_element,
    in Flow new_element)
    raises (Reflective::NotFound, Reflective::MofError);
void remove_source_flow (in Flow old_element)
    raises (Reflective::NotFound, Reflective::MofError);
TemplateParameterSet template_parameter3 ()
    raises (Reflective::MofError);
void set_template_parameter3 (in TemplateParameterSet new_value)
    raises (Reflective::MofError);
void add_template_parameter3 (in TemplateParameter new_element)
    raises (Reflective::MofError);
void modify_template_parameter3 (
    in TemplateParameter old_element,
    in TemplateParameter new_element)
    raises (Reflective::NotFound, Reflective::MofError);
void remove_template_parameter3 (in TemplateParameter old_element)
    raises (Reflective::NotFound, Reflective::MofError);
Core::Binding binding ()
    raises (Reflective::NotSet, Reflective::MofError);
void set_binding (in Core::Binding new_value)
    raises (Reflective::MofError);
void unset_binding ()
    raises (Reflective::MofError);
CommentSet comment ()
    raises (Reflective::MofError);
void set_comment (in CommentSet new_value)
    raises (Reflective::MofError);
void add_comment (in Core::Comment new_element)
    raises (Reflective::MofError);
void modify_comment (
    in Core::Comment old_element,
    in Core::Comment new_element)
    raises (Reflective::NotFound, Reflective::MofError);
void remove_comment (in Core::Comment old_element)
    raises (Reflective::NotFound, Reflective::MofError);
ElementResidenceSet element_residence ()
    raises (Reflective::MofError);
void set_element_residence (in ElementResidenceSet new_value)
    raises (Reflective::MofError);
void add_element_residence (in ElementResidence new_element)
    raises (Reflective::MofError);
void modify_element_residence (
    in ElementResidence old_element,
    in ElementResidence new_element)
    raises (Reflective::NotFound, Reflective::MofError);
void remove_element_residence (in ElementResidence old_element)
    raises (Reflective::NotFound, Reflective::MofError);
TemplateParameterUList template_parameter ()
    raises (Reflective::MofError);
```

```

void set_template_parameter (in TemplateParameterUList new_value)
  raises (Reflective::MofError);
void add_template_parameter (in TemplateParameter new_element)
  raises (Reflective::MofError);
void add_template_parameter_before (
  in TemplateParameter new_element,
  in TemplateParameter before_element)
  raises (Reflective::NotFound, Reflective::MofError);
void modify_template_parameter (
  in TemplateParameter old_element,
  in TemplateParameter new_element)
  raises (Reflective::NotFound, Reflective::MofError);
void remove_template_parameter (in TemplateParameter old_element)
  raises (Reflective::NotFound, Reflective::MofError);
TemplateParameterSet template_parameter2 ()
  raises (Reflective::MofError);
void set_template_parameter2 (in TemplateParameterSet new_value)
  raises (Reflective::MofError);
void add_template_parameter2 (in TemplateParameter new_element)
  raises (Reflective::MofError);
void modify_template_parameter2 (
  in TemplateParameter old_element,
  in TemplateParameter new_element)
  raises (Reflective::NotFound, Reflective::MofError);
void remove_template_parameter2 (in TemplateParameter old_element)
  raises (Reflective::NotFound, Reflective::MofError);
}; // end of interface ModelElement

```

```

interface NamespaceClass : ModelElementClass
{
  readonly attribute Core::NamespaceSet all_of_type_namespace;
  readonly attribute Core::NamespaceSet all_of_class_namespace;
  Core::Namespace create_namespace (
    in DataTypes::Name name,
    in DataTypes::VisibilityKind visibility,
    in boolean is_specification)
    raises (Reflective::MofError);
};

```

```

interface Namespace : NamespaceClass, ModelElement
{
  ModelElementSet owned_element ()
    raises (Reflective::MofError);
void set_owned_element (in ModelElementSet new_value)
  raises (Reflective::MofError);
void add_owned_element (in ModelElement new_element)
  raises (Reflective::MofError);
void modify_owned_element (
  in ModelElement old_element,
  in ModelElement new_element)
  raises (Reflective::NotFound, Reflective::MofError);
}

```

5 UML CORBAfacility InterfaceDefinition

```
void remove_owned_element (in ModelElement old_element)
    raises (Reflective::NotFound, Reflective::MofError);
}; // end of interface Namespace

interface GeneralizableElementClass : ModelElementClass
{
    readonly attribute GeneralizableElementSet all_of_type_generalizable_element;
};

interface GeneralizableElement : GeneralizableElementClass, ModelElement
{
    boolean is_root ()
        raises (Reflective::MofError);
    void set_is_root (in boolean new_value)
        raises (Reflective::MofError);
    boolean is_leaf ()
        raises (Reflective::MofError);
    void set_is_leaf (in boolean new_value)
        raises (Reflective::MofError);
    boolean is_abstract ()
        raises (Reflective::MofError);
    void set_is_abstract (in boolean new_value)
        raises (Reflective::MofError);
    GeneralizationSet generalization ()
        raises (Reflective::MofError);
    void set_generalization (in GeneralizationSet new_value)
        raises (Reflective::MofError);
    void add_generalization (in Core::Generalization new_element)
        raises (Reflective::MofError);
    void modify_generalization (
        in Core::Generalization old_element,
        in Core::Generalization new_element)
        raises (Reflective::NotFound, Reflective::MofError);
    void remove_generalization (in Core::Generalization old_element)
        raises (Reflective::NotFound, Reflective::MofError);
    GeneralizationSet specialization ()
        raises (Reflective::MofError);
    void set_specialization (in GeneralizationSet new_value)
        raises (Reflective::MofError);
    void add_specialization (in Core::Generalization new_element)
        raises (Reflective::MofError);
    void modify_specialization (
        in Core::Generalization old_element,
        in Core::Generalization new_element)
        raises (Reflective::NotFound, Reflective::MofError);
    void remove_specialization (in Core::Generalization old_element)
        raises (Reflective::NotFound, Reflective::MofError);
}; // end of interface GeneralizableElement

interface ClassifierClass : Core::NamespaceClass, GeneralizableElementClass
{
```

```

    readonly attribute ClassifierSet all_of_type_classifier;
};

interface Classifier : ClassifierClass, Core::Namespace, GeneralizableElement
{
    FeatureUList feature ()
        raises (Reflective::MofError);
    void set_feature (in FeatureUList new_value)
        raises (Reflective::MofError);
    void add_feature (in Core::Feature new_element)
        raises (Reflective::MofError);
    void add_feature_before (
        in Core::Feature new_element,
        in Core::Feature before_element)
        raises (Reflective::NotFound, Reflective::MofError);
    void modify_feature (
        in Core::Feature old_element,
        in Core::Feature new_element)
        raises (Reflective::NotFound, Reflective::MofError);
    void remove_feature (in Core::Feature old_element)
        raises (Reflective::NotFound, Reflective::MofError);
    AssociationEndSet participant ()
        raises (Reflective::MofError);
    void set_participant (in AssociationEndSet new_value)
        raises (Reflective::MofError);
    void add_participant (in AssociationEnd new_element)
        raises (Reflective::MofError);
    void modify_participant (
        in AssociationEnd old_element,
        in AssociationEnd new_element)
        raises (Reflective::NotFound, Reflective::MofError);
    void remove_participant (in AssociationEnd old_element)
        raises (Reflective::NotFound, Reflective::MofError);
    GeneralizationSet powertype_range ()
        raises (Reflective::MofError);
    void set_powertype_range (in GeneralizationSet new_value)
        raises (Reflective::MofError);
    void add_powertype_range (in Core::Generalization new_element)
        raises (Reflective::MofError);
    void modify_powertype_range (
        in Core::Generalization old_element,
        in Core::Generalization new_element)
        raises (Reflective::NotFound, Reflective::MofError);
    void remove_powertype_range (in Core::Generalization old_element)
        raises (Reflective::NotFound, Reflective::MofError);
}; // end of interface Classifier

interface ClassClass : ClassifierClass
{
    readonly attribute ClassSet all_of_type_class;
    readonly attribute ClassSet all_of_class_class;
};

```

5 UML CORBAfacility InterfaceDefinition

```
Class create_class (  
    in DataTypes::Name name,  
    in DataTypes::VisibilityKind visibility,  
    in boolean is_specification,  
    in boolean is_root,  
    in boolean is_leaf,  
    in boolean is_abstract,  
    in boolean is_active)  
    raises (Reflective::MofError);  
};  
  
interface Class : ClassClass, Classifier  
{  
    boolean is_active ()  
        raises (Reflective::MofError);  
    void set_is_active (in boolean new_value)  
        raises (Reflective::MofError);  
}; // end of interface Class  
  
interface DataTypeClass : ClassifierClass  
{  
    readonly attribute DataTypeSet all_of_type_data_type;  
    readonly attribute DataTypeSet all_of_class_data_type;  
    DataType create_data_type (  
        in DataTypes::Name name,  
        in DataTypes::VisibilityKind visibility,  
        in boolean is_specification,  
        in boolean is_root,  
        in boolean is_leaf,  
        in boolean is_abstract)  
        raises (Reflective::MofError);  
};  
  
interface DataType : DataTypeClass, Classifier  
{  
}; // end of interface DataType  
  
interface FeatureClass : ModelElementClass  
{  
    readonly attribute FeatureSet all_of_type_feature;  
};  
  
interface Feature : FeatureClass, ModelElement  
{  
    DataTypes::ScopeKind owner_scope ()  
        raises (Reflective::MofError);  
    void set_owner_scope (in DataTypes::ScopeKind new_value)  
        raises (Reflective::MofError);  
    Classifier owner ()  
        raises (Reflective::NotSet, Reflective::MofError);  
    void set_owner (in Classifier new_value)
```

```

    raises (Reflective::MofError);
    void unset_owner ()
        raises (Reflective::MofError);
}; // end of interface Feature

interface StructuralFeatureClass : FeatureClass
{
    readonly attribute StructuralFeatureSet all_of_type_structural_feature;
};

interface StructuralFeature : StructuralFeatureClass, Feature
{
    DataTypes::Multiplicity multiplicity ()
        raises (Reflective::MofError);
    void set_multiplicity (in DataTypes::Multiplicity new_value)
        raises (Reflective::MofError);
    DataTypes::ChangeableKind changeability ()
        raises (Reflective::MofError);
    void set_changeability (in DataTypes::ChangeableKind new_value)
        raises (Reflective::MofError);
    DataTypes::ScopeKind target_scope ()
        raises (Reflective::MofError);
    void set_target_scope (in DataTypes::ScopeKind new_value)
        raises (Reflective::MofError);
    Classifier type ()
        raises (Reflective::MofError);
    void set_type (in Classifier new_value)
        raises (Reflective::MofError);
}; // end of interface StructuralFeature

interface AssociationEndClass : ModelElementClass
{
    readonly attribute AssociationEndSet all_of_type_association_end;
    readonly attribute AssociationEndSet all_of_class_association_end;
    AssociationEnd create_association_end (
        in DataTypes::Name name,
        in DataTypes::VisibilityKind visibility,
        in boolean is_specification,
        in boolean is_navigable,
        in DataTypes::OrderingKind ordering,
        in DataTypes::AggregationKind aggregation,
        in DataTypes::ScopeKind target_scope,
        in DataTypes::Multiplicity multiplicity,
        in DataTypes::ChangeableKind changeability)
        raises (Reflective::MofError);
};

interface AssociationEnd : AssociationEndClass, ModelElement
{
    boolean is_navigable ()
        raises (Reflective::MofError);
};

```

5 UML CORBAfacility InterfaceDefinition

```
void set_is_navigable (in boolean new_value)
    raises (Reflective::MofError);
DataTypes::OrderingKind ordering ()
    raises (Reflective::MofError);
void set_ordering (in DataTypes::OrderingKind new_value)
    raises (Reflective::MofError);
DataTypes::AggregationKind aggregation ()
    raises (Reflective::MofError);
void set_aggregation (in DataTypes::AggregationKind new_value)
    raises (Reflective::MofError);
DataTypes::ScopeKind target_scope ()
    raises (Reflective::MofError);
void set_target_scope (in DataTypes::ScopeKind new_value)
    raises (Reflective::MofError);
DataTypes::Multiplicity multiplicity ()
    raises (Reflective::MofError);
void set_multiplicity (in DataTypes::Multiplicity new_value)
    raises (Reflective::MofError);
DataTypes::ChangeableKind changeability ()
    raises (Reflective::MofError);
void set_changeability (in DataTypes::ChangeableKind new_value)
    raises (Reflective::MofError);
Core::Association association ()
    raises (Reflective::MofError);
void set_association (in Core::Association new_value)
    raises (Reflective::MofError);
UmlAttributeUList qualifier ()
    raises (Reflective::MofError);
void set_qualifier (in UmlAttributeUList new_value)
    raises (Reflective::MofError);
void add_qualifier (in UmlAttribute new_element)
    raises (Reflective::MofError);
void add_qualifier_before (
    in UmlAttribute new_element,
    in UmlAttribute before_element)
    raises (Reflective::NotFound, Reflective::MofError);
void modify_qualifier (
    in UmlAttribute old_element,
    in UmlAttribute new_element)
    raises (Reflective::NotFound, Reflective::MofError);
void remove_qualifier (in UmlAttribute old_element)
    raises (Reflective::NotFound, Reflective::MofError);
Classifier type ()
    raises (Reflective::MofError);
void set_type (in Classifier new_value)
    raises (Reflective::MofError);
ClassifierSet specification ()
    raises (Reflective::MofError);
void set_specification (in ClassifierSet new_value)
    raises (Reflective::MofError);
void add_specification (in Classifier new_element)
```



```

        raises (Reflective::MofError);
void modify_specification (
    in Classifier old_element,
    in Classifier new_element)
    raises (Reflective::NotFound, Reflective::MofError);
void remove_specification (in Classifier old_element)
    raises (Reflective::NotFound, Reflective::MofError);
}; // end of interface AssociationEnd

interface UmlInterfaceClass : ClassifierClass
{
    readonly attribute UmlInterfaceSet all_of_type_uml_interface;
    readonly attribute UmlInterfaceSet all_of_class_uml_interface;
    UmlInterface create_uml_interface (
        in DataTypes::Name name,
        in DataTypes::VisibilityKind visibility,
        in boolean is_specification,
        in boolean is_root,
        in boolean is_leaf,
        in boolean is_abstract)
        raises (Reflective::MofError);
};

interface UmlInterface : UmlInterfaceClass, Classifier
{
}; // end of interface UmlInterface

interface UmlConstraintClass : ModelElementClass
{
    readonly attribute UmlConstraintSet all_of_type_uml_constraint;
    readonly attribute UmlConstraintSet all_of_class_uml_constraint;
    UmlConstraint create_uml_constraint (
        in DataTypes::Name name,
        in DataTypes::VisibilityKind visibility,
        in boolean is_specification,
        in DataTypes::BooleanExpression body)
        raises (Reflective::MofError);
};

interface UmlConstraint : UmlConstraintClass, ModelElement
{
    DataTypes::BooleanExpression body ()
        raises (Reflective::MofError);
    void set_body (in DataTypes::BooleanExpression new_value)
        raises (Reflective::MofError);
    ModelElementUList constrained_element ()
        raises (Reflective::MofError);
    void set_constrained_element (in ModelElementUList new_value)
        raises (Reflective::MofError);
    void unset_constrained_element ()
        raises (Reflective::MofError);
};

```

5 UML CORBAfacility InterfaceDefinition

```
void add_constrained_element (in ModelElement new_element)
    raises (Reflective::MofError);
void add_constrained_element_before (
    in ModelElement new_element,
    in ModelElement before_element)
    raises (Reflective::NotFound, Reflective::MofError);
void modify_constrained_element (
    in ModelElement old_element,
    in ModelElement new_element)
    raises (Reflective::NotFound, Reflective::MofError);
void remove_constrained_element (in ModelElement old_element)
    raises (Reflective::NotFound, Reflective::MofError);
}; // end of interface UmlConstraint

interface RelationshipClass : ModelElementClass
{
    readonly attribute RelationshipSet all_of_type_relationship;
};

interface Relationship : RelationshipClass, ModelElement
{
}; // end of interface Relationship

interface AssociationClass : GeneralizableElementClass, RelationshipClass
{
    readonly attribute AssociationSet all_of_type_association;
    readonly attribute AssociationSet all_of_class_association;
    Association create_association (
        in DataTypes::Name name,
        in DataTypes::VisibilityKind visibility,
        in boolean is_specification,
        in boolean is_root,
        in boolean is_leaf,
        in boolean is_abstract)
        raises (Reflective::MofError);
};

interface Association : AssociationClass, GeneralizableElement, Relationship
{
    AssociationEndSet connection ()
        raises (Reflective::MofError);
    void set_connection (in AssociationEndSet new_value)
        raises (Reflective::MofError);
    void add_connection (in AssociationEnd new_element)
        raises (Reflective::MofError);
    void modify_connection (
        in AssociationEnd old_element,
        in AssociationEnd new_element)
        raises (Reflective::NotFound, Reflective::MofError);
    void remove_connection (in AssociationEnd old_element)
        raises (Reflective::NotFound, Reflective::MofError);
};
```

```

}; // end of interface Association

interface UmlAttributeClass : StructuralFeatureClass
{
    readonly attribute UmlAttributeSet all_of_type_uml_attribute;
    readonly attribute UmlAttributeSet all_of_class_uml_attribute;
    UmlAttribute create_uml_attribute (
        in DataTypes::Name name,
        in DataTypes::VisibilityKind visibility,
        in boolean is_specification,
        in DataTypes::ScopeKind owner_scope,
        in DataTypes::Multiplicity multiplicity,
        in DataTypes::ChangeableKind changeability,
        in DataTypes::ScopeKind target_scope,
        in DataTypes::Expression initial_value)
        raises (Reflective::MofError);
};

interface UmlAttribute : UmlAttributeClass, StructuralFeature
{
    DataTypes::Expression initial_value ()
        raises (Reflective::MofError);
    void set_initial_value (in DataTypes::Expression new_value)
        raises (Reflective::MofError);
    AssociationEnd association_end ()
        raises (Reflective::NotSet, Reflective::MofError);
    void set_association_end (in AssociationEnd new_value)
        raises (Reflective::MofError);
    void unset_association_end ()
        raises (Reflective::MofError);
}; // end of interface UmlAttribute

interface BehavioralFeatureClass : FeatureClass
{
    readonly attribute BehavioralFeatureSet all_of_type_behavioral_feature;
};

interface BehavioralFeature : BehavioralFeatureClass, Feature
{
    boolean is_query ()
        raises (Reflective::MofError);
    void set_is_query (in boolean new_value)
        raises (Reflective::MofError);
    ParameterUList parameter ()
        raises (Reflective::MofError);
    void set_parameter (in ParameterUList new_value)
        raises (Reflective::MofError);
    void add_parameter (in Core::Parameter new_element)
        raises (Reflective::MofError);
    void add_parameter_before (
        in Core::Parameter new_element,

```

5 UML CORBAfacility InterfaceDefinition

```
    in Core::Parameter before_element)
    raises (Reflective::NotFound, Reflective::MofError);
void modify_parameter (
    in Core::Parameter old_element,
    in Core::Parameter new_element)
    raises (Reflective::NotFound, Reflective::MofError);
void remove_parameter (in Core::Parameter old_element)
    raises (Reflective::NotFound, Reflective::MofError);
}; // end of interface BehavioralFeature

interface OperationClass : BehavioralFeatureClass
{
    readonly attribute OperationSet all_of_type_operation;
    readonly attribute OperationSet all_of_class_operation;
    Operation create_operation (
        in DataTypes::Name name,
        in DataTypes::VisibilityKind visibility,
        in boolean is_specification,
        in DataTypes::ScopeKind owner_scope,
        in boolean is_query,
        in DataTypes::CallConcurrencyKind concurrency,
        in boolean is_root,
        in boolean is_leaf,
        in boolean is_abstract,
        in string specification)
        raises (Reflective::MofError);
};

interface Operation : OperationClass, BehavioralFeature
{
    DataTypes::CallConcurrencyKind concurrency ()
        raises (Reflective::MofError);
    void set_concurrency (in DataTypes::CallConcurrencyKind new_value)
        raises (Reflective::MofError);
    boolean is_root ()
        raises (Reflective::MofError);
    void set_is_root (in boolean new_value)
        raises (Reflective::MofError);
    boolean is_leaf ()
        raises (Reflective::MofError);
    void set_is_leaf (in boolean new_value)
        raises (Reflective::MofError);
    boolean is_abstract ()
        raises (Reflective::MofError);
    void set_is_abstract (in boolean new_value)
        raises (Reflective::MofError);
    string specification ()
        raises (Reflective::MofError);
    void set_specification (in string new_value)
        raises (Reflective::MofError);
    MethodSet method ()
```

```

    raises (Reflective::MofError);
void set_method (in MethodSet new_value)
    raises (Reflective::MofError);
void add_method (in Core::Method new_element)
    raises (Reflective::MofError);
void modify_method (
    in Core::Method old_element,
    in Core::Method new_element)
    raises (Reflective::NotFound, Reflective::MofError);
void remove_method (in Core::Method old_element)
    raises (Reflective::NotFound, Reflective::MofError);
}; // end of interface Operation

interface ParameterClass : ModelElementClass
{
    readonly attribute ParameterSet all_of_type_parameter;
    readonly attribute ParameterSet all_of_class_parameter;
    Parameter create_parameter (
        in DataTypes::Name name,
        in DataTypes::VisibilityKind visibility,
        in boolean is_specification,
        in DataTypes::Expression default_value,
        in DataTypes::ParameterDirectionKind kind)
        raises (Reflective::MofError);
};

interface Parameter : ParameterClass, ModelElement
{
    DataTypes::Expression default_value ()
        raises (Reflective::MofError);
    void set_default_value (in DataTypes::Expression new_value)
        raises (Reflective::MofError);
    DataTypes::ParameterDirectionKind kind ()
        raises (Reflective::MofError);
    void set_kind (in DataTypes::ParameterDirectionKind new_value)
        raises (Reflective::MofError);
    BehavioralFeature behavioral_feature ()
        raises (Reflective::NotSet, Reflective::MofError);
    void set_behavioral_feature (in BehavioralFeature new_value)
        raises (Reflective::MofError);
    void unset_behavioral_feature ()
        raises (Reflective::MofError);
    Classifier type ()
        raises (Reflective::MofError);
    void set_type (in Classifier new_value)
        raises (Reflective::MofError);
}; // end of interface Parameter

interface MethodClass : BehavioralFeatureClass
{
    readonly attribute MethodSet all_of_type_method;

```

5 UML CORBAfacility InterfaceDefinition

```
readonly attribute MethodSet all_of_class_method;
Method create_method (
  in DataTypes::Name name,
  in DataTypes::VisibilityKind visibility,
  in boolean is_specification,
  in DataTypes::ScopeKind owner_scope,
  in boolean is_query,
  in DataTypes::ProcedureExpression body)
  raises (Reflective::MofError);
};

interface Method : MethodClass, BehavioralFeature
{
  DataTypes::ProcedureExpression body ()
    raises (Reflective::MofError);
  void set_body (in DataTypes::ProcedureExpression new_value)
    raises (Reflective::MofError);
  Operation specification ()
    raises (Reflective::MofError);
  void set_specification (in Operation new_value)
    raises (Reflective::MofError);
}; // end of interface Method

interface GeneralizationClass : RelationshipClass
{
  readonly attribute GeneralizationSet all_of_type_generalization;
  readonly attribute GeneralizationSet all_of_class_generalization;
  Generalization create_generalization (
    in DataTypes::Name name,
    in DataTypes::VisibilityKind visibility,
    in boolean is_specification,
    in DataTypes::Name discriminator)
    raises (Reflective::MofError);
};

interface Generalization : GeneralizationClass, Relationship
{
  DataTypes::Name discriminator ()
    raises (Reflective::MofError);
  void set_discriminator (in DataTypes::Name new_value)
    raises (Reflective::MofError);
  GeneralizableElement child ()
    raises (Reflective::MofError);
  void set_child (in GeneralizableElement new_value)
    raises (Reflective::MofError);
  GeneralizableElement parent ()
    raises (Reflective::MofError);
  void set_parent (in GeneralizableElement new_value)
    raises (Reflective::MofError);
  Classifier powertype ()
    raises (Reflective::NotSet, Reflective::MofError);
};
```

```

void set_powertype (in Classifier new_value)
  raises (Reflective::MofError);
void unset_powertype ()
  raises (Reflective::MofError);
}; // end of interface Generalization

interface UmlAssociationClassClass : ClassClass, AssociationClass
{
  readonly attribute UmlAssociationClassSet all_of_type_uml_association_class;
  readonly attribute UmlAssociationClassSet all_of_class_uml_association_class;
  UmlAssociationClass create_uml_association_class (
    in DataTypes::Name name,
    in DataTypes::VisibilityKind visibility,
    in boolean is_specification,
    in boolean is_root,
    in boolean is_leaf,
    in boolean is_abstract,
    in boolean is_active)
    raises (Reflective::MofError);
};

interface UmlAssociationClass : UmlAssociationClassClass, Class, Association
{
}; // end of interface UmlAssociationClass

interface DependencyClass : RelationshipClass
{
  readonly attribute DependencySet all_of_type_dependency;
};

interface Dependency : DependencyClass, Relationship
{
  ModelElementSet client ()
    raises (Reflective::MofError);
  void set_client (in ModelElementSet new_value)
    raises (Reflective::MofError);
  void add_client (in ModelElement new_element)
    raises (Reflective::MofError);
  void modify_client (
    in ModelElement old_element,
    in ModelElement new_element)
    raises (Reflective::NotFound, Reflective::MofError);
  void remove_client (in ModelElement old_element)
    raises (Reflective::NotFound, Reflective::MofError);
  ModelElementSet supplier ()
    raises (Reflective::MofError);
  void set_supplier (in ModelElementSet new_value)
    raises (Reflective::MofError);
  void add_supplier (in ModelElement new_element)
    raises (Reflective::MofError);
  void modify_supplier (

```

5 UML CORBAfacility InterfaceDefinition

```
        in ModelElement old_element,
        in ModelElement new_element)
        raises (Reflective::NotFound, Reflective::MofError);
    void remove_supplier (in ModelElement old_element)
        raises (Reflective::NotFound, Reflective::MofError);
}; // end of interface Dependency

interface AbstractionClass : DependencyClass
{
    readonly attribute AbstractionSet all_of_type_abstraction;
    readonly attribute AbstractionSet all_of_class_abstraction;
    Abstraction create_abstraction (
        in DataTypes::Name name,
        in DataTypes::VisibilityKind visibility,
        in boolean is_specification,
        in DataTypes::MappingExpression mapping)
        raises (Reflective::MofError);
};

interface Abstraction : AbstractionClass, Dependency
{
    DataTypes::MappingExpression mapping ()
        raises (Reflective::MofError);
    void set_mapping (in DataTypes::MappingExpression new_value)
        raises (Reflective::MofError);
}; // end of interface Abstraction

interface PresentationElementClass : ElementClass
{
    readonly attribute PresentationElementSet all_of_type_presentation_element;
};

interface PresentationElement : PresentationElementClass, Element
{
    ModelElementSet subject ()
        raises (Reflective::MofError);
    void set_subject (in ModelElementSet new_value)
        raises (Reflective::MofError);
    void add_subject (in ModelElement new_element)
        raises (Reflective::MofError);
    void modify_subject (
        in ModelElement old_element,
        in ModelElement new_element)
        raises (Reflective::NotFound, Reflective::MofError);
    void remove_subject (in ModelElement old_element)
        raises (Reflective::NotFound, Reflective::MofError);
}; // end of interface PresentationElement

interface UsageClass : DependencyClass
{
    readonly attribute UsageSet all_of_type_usage;
```



```

    readonly attribute UsageSet all_of_class_usage;
    Usage create_usage (
        in DataTypes::Name name,
        in DataTypes::VisibilityKind visibility,
        in boolean is_specification)
        raises (Reflective::MofError);
};

interface Usage : UsageClass, Dependency
{
}; // end of interface Usage

interface BindingClass : DependencyClass
{
    readonly attribute Core::BindingSet all_of_type_binding;
    readonly attribute Core::BindingSet all_of_class_binding;
    Core::Binding create_binding (
        in DataTypes::Name name,
        in DataTypes::VisibilityKind visibility,
        in boolean is_specification)
        raises (Reflective::MofError);
};

interface Binding : BindingClass, Dependency
{
    ModelElementUList argument ()
        raises (Reflective::MofError);
    void set_argument (in ModelElementUList new_value)
        raises (Reflective::MofError);
    void add_argument (in ModelElement new_element)
        raises (Reflective::MofError);
    void add_argument_before (
        in ModelElement new_element,
        in ModelElement before_element)
        raises (Reflective::NotFound, Reflective::MofError);
    void modify_argument (
        in ModelElement old_element,
        in ModelElement new_element)
        raises (Reflective::NotFound, Reflective::MofError);
    void remove_argument (in ModelElement old_element)
        raises (Reflective::NotFound, Reflective::MofError);
}; // end of interface Binding

interface ComponentClass : ClassifierClass
{
    readonly attribute ComponentSet all_of_type_component;
    readonly attribute ComponentSet all_of_class_component;
    Component create_component (
        in DataTypes::Name name,
        in DataTypes::VisibilityKind visibility,
        in boolean is_specification,

```

5 UML CORBAfacility InterfaceDefinition

```
        in boolean is_root,
        in boolean is_leaf,
        in boolean is_abstract)
        raises (Reflective::MofError);
};

interface Component : ComponentClass, Classifier
{
    NodeSet deployment_location ()
        raises (Reflective::MofError);
    void set_deployment_location (in NodeSet new_value)
        raises (Reflective::MofError);
    void add_deployment_location (in Node new_element)
        raises (Reflective::MofError);
    void modify_deployment_location (
        in Node old_element,
        in Node new_element)
        raises (Reflective::NotFound, Reflective::MofError);
    void remove_deployment_location (in Node old_element)
        raises (Reflective::NotFound, Reflective::MofError);
    ElementResidenceSet resident_element ()
        raises (Reflective::MofError);
    void set_resident_element (in ElementResidenceSet new_value)
        raises (Reflective::MofError);
    void add_resident_element (in ElementResidence new_element)
        raises (Reflective::MofError);
    void modify_resident_element (
        in ElementResidence old_element,
        in ElementResidence new_element)
        raises (Reflective::NotFound, Reflective::MofError);
    void remove_resident_element (in ElementResidence old_element)
        raises (Reflective::NotFound, Reflective::MofError);
}; // end of interface Component

interface NodeClass : ClassifierClass
{
    readonly attribute NodeSet all_of_type_node;
    readonly attribute NodeSet all_of_class_node;
    Node create_node (
        in DataTypes::Name name,
        in DataTypes::VisibilityKind visibility,
        in boolean is_specification,
        in boolean is_root,
        in boolean is_leaf,
        in boolean is_abstract)
        raises (Reflective::MofError);
};

interface Node : NodeClass, Classifier
{
    ComponentSet resident ()
}
```

```

    raises (Reflective::MofError);
void set_resident (in ComponentSet new_value)
    raises (Reflective::MofError);
void add_resident (in Component new_element)
    raises (Reflective::MofError);
void modify_resident (
    in Component old_element,
    in Component new_element)
    raises (Reflective::NotFound, Reflective::MofError);
void remove_resident (in Component old_element)
    raises (Reflective::NotFound, Reflective::MofError);
}; // end of interface Node

interface PermissionClass : DependencyClass
{
    readonly attribute PermissionSet all_of_type_permission;
    readonly attribute PermissionSet all_of_class_permission;
    Permission create_permission (
        in DataTypes::Name name,
        in DataTypes::VisibilityKind visibility,
        in boolean is_specification)
        raises (Reflective::MofError);
};

interface Permission : PermissionClass, Dependency
{
}; // end of interface Permission

interface CommentClass : ModelElementClass
{
    readonly attribute Core::CommentSet all_of_type_comment;
    readonly attribute Core::CommentSet all_of_class_comment;
    Core::Comment create_comment (
        in DataTypes::Name name,
        in DataTypes::VisibilityKind visibility,
        in boolean is_specification)
        raises (Reflective::MofError);
};

interface Comment : CommentClass, ModelElement
{
    ModelElementSet annotated_element ()
        raises (Reflective::MofError);
void set_annotated_element (in ModelElementSet new_value)
    raises (Reflective::MofError);
void add_annotated_element (in ModelElement new_element)
    raises (Reflective::MofError);
void modify_annotated_element (
    in ModelElement old_element,
    in ModelElement new_element)
    raises (Reflective::NotFound, Reflective::MofError);
};

```

5 UML CORBAfacility InterfaceDefinition

```
void remove_annotated_element (in ModelElement old_element)
    raises (Reflective::NotFound, Reflective::MofError);
}; // end of interface Comment

interface FlowClass : RelationshipClass
{
    readonly attribute FlowSet all_of_type_flow;
    readonly attribute FlowSet all_of_class_flow;
    Flow create_flow (
        in DataTypes::Name name,
        in DataTypes::VisibilityKind visibility,
        in boolean is_specification)
        raises (Reflective::MofError);
};

interface Flow : FlowClass, Relationship
{
    ModelElementSet target ()
        raises (Reflective::MofError);
    void set_target (in ModelElementSet new_value)
        raises (Reflective::MofError);
    void add_target (in ModelElement new_element)
        raises (Reflective::MofError);
    void modify_target (
        in ModelElement old_element,
        in ModelElement new_element)
        raises (Reflective::NotFound, Reflective::MofError);
    void remove_target (in ModelElement old_element)
        raises (Reflective::NotFound, Reflective::MofError);
    ModelElementSet source ()
        raises (Reflective::MofError);
    void set_source (in ModelElementSet new_value)
        raises (Reflective::MofError);
    void add_source (in ModelElement new_element)
        raises (Reflective::MofError);
    void modify_source (
        in ModelElement old_element,
        in ModelElement new_element)
        raises (Reflective::NotFound, Reflective::MofError);
    void remove_source (in ModelElement old_element)
        raises (Reflective::NotFound, Reflective::MofError);
}; // end of interface Flow

interface ElementResidenceClass : Reflective::RefObject
{
    readonly attribute ElementResidenceSet all_of_type_element_residence;
    readonly attribute ElementResidenceSet all_of_class_element_residence;
    ElementResidence create_element_residence (
        in DataTypes::VisibilityKind visibility)
        raises (Reflective::MofError);
};
```

```

interface ElementResidence : ElementResidenceClass
{
    DataTypes::VisibilityKind visibility ()
        raises (Reflective::MofError);
    void set_visibility (in DataTypes::VisibilityKind new_value)
        raises (Reflective::MofError);
    ModelElement resident ()
        raises (Reflective::MofError);
    void set_resident (in ModelElement new_value)
        raises (Reflective::MofError);
    Component implementation_location ()
        raises (Reflective::MofError);
    void set_implementation_location (in Component new_value)
        raises (Reflective::MofError);
}; // end of interface ElementResidence

interface TemplateParameterClass : Reflective::RefObject
{
    readonly attribute TemplateParameterSet all_of_type_template_parameter;
    readonly attribute TemplateParameterSet all_of_class_template_parameter;
    TemplateParameter create_template_parameter ()
        raises (Reflective::MofError);
};

interface TemplateParameter : TemplateParameterClass
{
    ModelElement default_element ()
        raises (Reflective::NotSet, Reflective::MofError);
    void set_default_element (in ModelElement new_value)
        raises (Reflective::MofError);
    void unset_default_element ()
        raises (Reflective::MofError);
    ModelElement model_element ()
        raises (Reflective::NotSet, Reflective::MofError);
    void set_model_element (in ModelElement new_value)
        raises (Reflective::MofError);
    void unset_model_element ()
        raises (Reflective::MofError);
    ModelElement model_element2 ()
        raises (Reflective::MofError);
    void set_model_element2 (in ModelElement new_value)
        raises (Reflective::MofError);
}; // end of interface TemplateParameter

struct AAssociationConnectionLink
{
    Core::Association association;
    AssociationEnd connection;
};
typedef sequence<AAssociationConnectionLink> AAssociationConnectionLinkSet;

```

5 UML CORBAfacility InterfaceDefinition

```
interface AAssociationConnection : Reflective::RefAssociation
{
  AAssociationConnectionLinkSet all_a_association_connection_links()
    raises (Reflective::MofError);
  boolean exists (
    in Core::Association association,
    in AssociationEnd connection)
    raises (Reflective::MofError);
  Core::Association association (in AssociationEnd connection)
    raises (Reflective::MofError);
  AssociationEndSet connection (in Core::Association association)
    raises (Reflective::MofError);
  void add (
    in Core::Association association,
    in AssociationEnd connection)
    raises (Reflective::MofError);
  void modify_association (
    in Core::Association association,
    in AssociationEnd connection,
    in Core::Association new_association)
    raises (Reflective::NotFound, Reflective::MofError);
  void modify_connection (
    in Core::Association association,
    in AssociationEnd connection,
    in AssociationEnd new_connection)
    raises (Reflective::NotFound, Reflective::MofError);
  void remove (
    in Core::Association association,
    in AssociationEnd connection)
    raises (Reflective::NotFound, Reflective::MofError);
}; // end of interface AAssociationConnection

struct AOwnerFeatureLink
{
  Classifier owner;
  Core::Feature feature;
};
typedef sequence<AOwnerFeatureLink> AOwnerFeatureLinkSet;

interface AOwnerFeature : Reflective::RefAssociation
{
  AOwnerFeatureLinkSet all_a_owner_feature_links()
    raises (Reflective::MofError);
  boolean exists (
    in Classifier owner,
    in Core::Feature feature)
    raises (Reflective::MofError);
  Classifier owner (in Core::Feature feature)
    raises (Reflective::MofError);
  FeatureUList feature (in Classifier owner)
```

```

    raises (Reflective::MofError);
void add (
    in Classifier owner,
    in Core::Feature feature)
    raises (Reflective::MofError);
void add_before_feature (
    in Classifier owner,
    in Core::Feature feature,
    in Core::Feature before)
    raises (Reflective::NotFound, Reflective::MofError);
void modify_owner (
    in Classifier owner,
    in Core::Feature feature,
    in Classifier new_owner)
    raises (Reflective::NotFound, Reflective::MofError);
void modify_feature (
    in Classifier owner,
    in Core::Feature feature,
    in Core::Feature new_feature)
    raises (Reflective::NotFound, Reflective::MofError);
void remove (
    in Classifier owner,
    in Core::Feature feature)
    raises (Reflective::NotFound, Reflective::MofError);
}; // end of interface AOwnerFeature

struct ASpecificationMethodLink
{
    Operation specification;
    Core::Method method;
};
typedef sequence<ASpecificationMethodLink> ASpecificationMethodLinkSet;

interface ASpecificationMethod : Reflective::RefAssociation
{
    ASpecificationMethodLinkSet all_a_specification_method_links()
        raises (Reflective::MofError);
    boolean exists (
        in Operation specification,
        in Core::Method method)
        raises (Reflective::MofError);
    Operation specification (in Core::Method method)
        raises (Reflective::MofError);
    MethodSet method (in Operation specification)
        raises (Reflective::MofError);
    void add (
        in Operation specification,
        in Core::Method method)
        raises (Reflective::MofError);
    void modify_specification (
        in Operation specification,

```

5 UML CORBAfacility InterfaceDefinition

```
    in Core::Method method,
    in Operation new_specification)
    raises (Reflective::NotFound, Reflective::MofError);
void modify_method (
    in Operation specification,
    in Core::Method method,
    in Core::Method new_method)
    raises (Reflective::NotFound, Reflective::MofError);
void remove (
    in Operation specification,
    in Core::Method method)
    raises (Reflective::NotFound, Reflective::MofError);
}; // end of interface ASpecificationMethod

struct AStructuralFeatureTypeLink
{
    StructuralFeature structural_feature;
    Classifier type;
};
typedef sequence<AStructuralFeatureTypeLink> AStructuralFeatureTypeLinkSet;

interface AStructuralFeatureType : Reflective::RefAssociation
{
    AStructuralFeatureTypeLinkSet all_a_structural_feature_type_links()
        raises (Reflective::MofError);
    boolean exists (
        in StructuralFeature structural_feature,
        in Classifier type)
        raises (Reflective::MofError);
    Classifier type (in StructuralFeature structural_feature)
        raises (Reflective::MofError);
    void add (
        in StructuralFeature structural_feature,
        in Classifier type)
        raises (Reflective::MofError);
    void modify_type (
        in StructuralFeature structural_feature,
        in Classifier type,
        in Classifier new_type)
        raises (Reflective::NotFound, Reflective::MofError);
    void remove (
        in StructuralFeature structural_feature,
        in Classifier type)
        raises (Reflective::NotFound, Reflective::MofError);
}; // end of interface AStructuralFeatureType

struct ANamespaceOwnedElementLink
{
    Core::Namespace namespace;
    ModelElement owned_element;
};
```



```

typedef sequence<ANamespaceOwnedElementLink> ANamespaceOwnedElementLinkSet;

interface ANamespaceOwnedElement : Reflective::RefAssociation
{
    ANamespaceOwnedElementLinkSet all_a_namespace_owned_element_links()
        raises (Reflective::MofError);
    boolean exists (
        in Core::Namespace namespace,
        in ModelElement owned_element)
        raises (Reflective::MofError);
    Core::Namespace namespace (in ModelElement owned_element)
        raises (Reflective::MofError);
    ModelElementSet owned_element (in Core::Namespace namespace)
        raises (Reflective::MofError);
    void add (
        in Core::Namespace namespace,
        in ModelElement owned_element)
        raises (Reflective::MofError);
    void modify_namespace (
        in Core::Namespace namespace,
        in ModelElement owned_element,
        in Core::Namespace new_namespace)
        raises (Reflective::NotFound, Reflective::MofError);
    void modify_owned_element (
        in Core::Namespace namespace,
        in ModelElement owned_element,
        in ModelElement new_owned_element)
        raises (Reflective::NotFound, Reflective::MofError);
    void remove (
        in Core::Namespace namespace,
        in ModelElement owned_element)
        raises (Reflective::NotFound, Reflective::MofError);
}; // end of interface ANamespaceOwnedElement

struct ABehavioralFeatureParameterLink
{
    BehavioralFeature behavioral_feature;
    Core::Parameter parameter;
};
typedef sequence<ABehavioralFeatureParameterLink>
    ABehavioralFeatureParameterLinkSet;

interface ABehavioralFeatureParameter : Reflective::RefAssociation
{
    ABehavioralFeatureParameterLinkSet all_a_behavioral_feature_parameter_links()
        raises (Reflective::MofError);
    boolean exists (
        in BehavioralFeature behavioral_feature,
        in Core::Parameter parameter)
        raises (Reflective::MofError);
    BehavioralFeature behavioral_feature (in Core::Parameter parameter)

```

5 UML CORBAfacility InterfaceDefinition

```
    raises (Reflective::MofError);
ParameterUList parameter (in BehavioralFeature behavioral_feature)
    raises (Reflective::MofError);
void add (
    in BehavioralFeature behavioral_feature,
    in Core::Parameter parameter)
    raises (Reflective::MofError);
void add_before_parameter (
    in BehavioralFeature behavioral_feature,
    in Core::Parameter parameter,
    in Core::Parameter before)
    raises (Reflective::NotFound, Reflective::MofError);
void modify_behavioral_feature (
    in BehavioralFeature behavioral_feature,
    in Core::Parameter parameter,
    in BehavioralFeature new_behavioral_feature)
    raises (Reflective::NotFound, Reflective::MofError);
void modify_parameter (
    in BehavioralFeature behavioral_feature,
    in Core::Parameter parameter,
    in Core::Parameter new_parameter)
    raises (Reflective::NotFound, Reflective::MofError);
void remove (
    in BehavioralFeature behavioral_feature,
    in Core::Parameter parameter)
    raises (Reflective::NotFound, Reflective::MofError);
}; // end of interface ABehavioralFeatureParameter

struct AParameterTypeLink
{
    Core::Parameter parameter;
    Classifier type;
};
typedef sequence<AParameterTypeLink> AParameterTypeLinkSet;

interface AParameterType : Reflective::RefAssociation
{
    AParameterTypeLinkSet all_a_parameter_type_links()
        raises (Reflective::MofError);
    boolean exists (
        in Core::Parameter parameter,
        in Classifier type)
        raises (Reflective::MofError);
    Classifier type (in Core::Parameter parameter)
        raises (Reflective::MofError);
    void add (
        in Core::Parameter parameter,
        in Classifier type)
        raises (Reflective::MofError);
    void modify_type (
        in Core::Parameter parameter,
```

```

    in Classifier type,
    in Classifier new_type)
    raises (Reflective::NotFound, Reflective::MofError);
void remove (
    in Core::Parameter parameter,
    in Classifier type)
    raises (Reflective::NotFound, Reflective::MofError);
}; // end of interface AParameterType

struct AChildGeneralizationLink
{
    GeneralizableElement child;
    Core::Generalization generalization;
};
typedef sequence<AChildGeneralizationLink> AChildGeneralizationLinkSet;

interface AChildGeneralization : Reflective::RefAssociation
{
    AChildGeneralizationLinkSet all_a_child_generalization_links()
        raises (Reflective::MofError);
    boolean exists (
        in GeneralizableElement child,
        in Core::Generalization generalization)
        raises (Reflective::MofError);
    GeneralizableElement child (in Core::Generalization generalization)
        raises (Reflective::MofError);
    GeneralizationSet generalization (in GeneralizableElement child)
        raises (Reflective::MofError);
    void add (
        in GeneralizableElement child,
        in Core::Generalization generalization)
        raises (Reflective::MofError);
    void modify_child (
        in GeneralizableElement child,
        in Core::Generalization generalization,
        in GeneralizableElement new_child)
        raises (Reflective::NotFound, Reflective::MofError);
    void modify_generalization (
        in GeneralizableElement child,
        in Core::Generalization generalization,
        in Core::Generalization new_generalization)
        raises (Reflective::NotFound, Reflective::MofError);
    void remove (
        in GeneralizableElement child,
        in Core::Generalization generalization)
        raises (Reflective::NotFound, Reflective::MofError);
}; // end of interface AChildGeneralization

struct AParentSpecializationLink
{
    GeneralizableElement parent;

```

5 UML CORBAfacility InterfaceDefinition

```
    Generalization specialization;
};
typedef sequence<AParentSpecializationLink> AParentSpecializationLinkSet;

interface AParentSpecialization : Reflective::RefAssociation
{
    AParentSpecializationLinkSet all_a_parent_specialization_links()
        raises (Reflective::MofError);
    boolean exists (
        in GeneralizableElement parent,
        in Generalization specialization)
        raises (Reflective::MofError);
    GeneralizableElement parent (in Generalization specialization)
        raises (Reflective::MofError);
    GeneralizationSet specialization (in GeneralizableElement parent)
        raises (Reflective::MofError);
    void add (
        in GeneralizableElement parent,
        in Generalization specialization)
        raises (Reflective::MofError);
    void modify_parent (
        in GeneralizableElement parent,
        in Generalization specialization,
        in GeneralizableElement new_parent)
        raises (Reflective::NotFound, Reflective::MofError);
    void modify_specialization (
        in GeneralizableElement parent,
        in Generalization specialization,
        in Generalization new_specialization)
        raises (Reflective::NotFound, Reflective::MofError);
    void remove (
        in GeneralizableElement parent,
        in Generalization specialization)
        raises (Reflective::NotFound, Reflective::MofError);
}; // end of interface AParentSpecialization

struct AQualifierAssociationEndLink
{
    UmlAttribute qualifier;
    AssociationEnd association_end;
};
typedef sequence<AQualifierAssociationEndLink> AQualifierAssociationEndLinkSet;

interface AQualifierAssociationEnd : Reflective::RefAssociation
{
    AQualifierAssociationEndLinkSet all_a_qualifier_association_end_links()
        raises (Reflective::MofError);
    boolean exists (
        in UmlAttribute qualifier,
        in AssociationEnd association_end)
        raises (Reflective::MofError);
};
```

```

UmlAttributeUList qualifier (in AssociationEnd association_end)
  raises (Reflective::MofError);
AssociationEnd association_end (in UmlAttribute qualifier)
  raises (Reflective::MofError);
void add (
  in UmlAttribute qualifier,
  in AssociationEnd association_end)
  raises (Reflective::MofError);
void add_before_qualifier (
  in UmlAttribute qualifier,
  in AssociationEnd association_end,
  in UmlAttribute before)
  raises (Reflective::NotFound, Reflective::MofError);
void modify_qualifier (
  in UmlAttribute qualifier,
  in AssociationEnd association_end,
  in UmlAttribute new_qualifier)
  raises (Reflective::NotFound, Reflective::MofError);
void modify_association_end (
  in UmlAttribute qualifier,
  in AssociationEnd association_end,
  in AssociationEnd new_association_end)
  raises (Reflective::NotFound, Reflective::MofError);
void remove (
  in UmlAttribute qualifier,
  in AssociationEnd association_end)
  raises (Reflective::NotFound, Reflective::MofError);
}; // end of interface AQualifierAssociationEnd

struct ATypeAssociationEndLink
{
  Classifier type;
  AssociationEnd association_end;
};
typedef sequence<ATypeAssociationEndLink> ATypeAssociationEndLinkSet;

interface ATypeAssociationEnd : Reflective::RefAssociation
{
  ATypeAssociationEndLinkSet all_a_type_association_end_links()
    raises (Reflective::MofError);
  boolean exists (
    in Classifier type,
    in AssociationEnd association_end)
    raises (Reflective::MofError);
  Classifier type (in AssociationEnd association_end)
    raises (Reflective::MofError);
  void add (
    in Classifier type,
    in AssociationEnd association_end)
    raises (Reflective::MofError);
  void modify_type (

```

5 UML CORBAfacility InterfaceDefinition

```
    in Classifier type,
    in AssociationEnd association_end,
    in Classifier new_type)
    raises (Reflective::NotFound, Reflective::MofError);
void remove (
    in Classifier type,
    in AssociationEnd association_end)
    raises (Reflective::NotFound, Reflective::MofError);
}; // end of interface ATypeAssociationEnd

struct AParticipantSpecificationLink
{
    AssociationEnd participant;
    Classifier specification;
};
typedef sequence<AParticipantSpecificationLink> AParticipantSpecificationLinkSet;

interface AParticipantSpecification : Reflective::RefAssociation
{
    AParticipantSpecificationLinkSet all_a_participant_specification_links()
        raises (Reflective::MofError);
    boolean exists (
        in AssociationEnd participant,
        in Classifier specification)
        raises (Reflective::MofError);
    AssociationEndSet participant (in Classifier specification)
        raises (Reflective::MofError);
    ClassifierSet specification (in AssociationEnd participant)
        raises (Reflective::MofError);
    void add (
        in AssociationEnd participant,
        in Classifier specification)
        raises (Reflective::MofError);
    void modify_participant (
        in AssociationEnd participant,
        in Classifier specification,
        in AssociationEnd new_participant)
        raises (Reflective::NotFound, Reflective::MofError);
    void modify_specification (
        in AssociationEnd participant,
        in Classifier specification,
        in Classifier new_specification)
        raises (Reflective::NotFound, Reflective::MofError);
    void remove (
        in AssociationEnd participant,
        in Classifier specification)
        raises (Reflective::NotFound, Reflective::MofError);
}; // end of interface AParticipantSpecification

struct AClientClientDependencyLink
{
```

```

    ModelElement client;
    Dependency client_dependency;
};
typedef sequence<AClientClientDependencyLink> AClientClientDependencyLinkSet;

interface AClientClientDependency : Reflective::RefAssociation
{
    AClientClientDependencyLinkSet all_a_client_client_dependency_links()
        raises (Reflective::MofError);
    boolean exists (
        in ModelElement client,
        in Dependency client_dependency)
        raises (Reflective::MofError);
    ModelElementSet client (in Dependency client_dependency)
        raises (Reflective::MofError);
    DependencySet client_dependency (in ModelElement client)
        raises (Reflective::MofError);
    void add (
        in ModelElement client,
        in Dependency client_dependency)
        raises (Reflective::MofError);
    void modify_client (
        in ModelElement client,
        in Dependency client_dependency,
        in ModelElement new_client)
        raises (Reflective::NotFound, Reflective::MofError);
    void modify_client_dependency (
        in ModelElement client,
        in Dependency client_dependency,
        in Dependency new_client_dependency)
        raises (Reflective::NotFound, Reflective::MofError);
    void remove (
        in ModelElement client,
        in Dependency client_dependency)
        raises (Reflective::NotFound, Reflective::MofError);
}; // end of interface AClientClientDependency

struct AConstrainedElementConstraintLink
{
    ModelElement constrained_element;
    UmlConstraint uml_constraint;
};
typedef sequence<AConstrainedElementConstraintLink>
    AConstrainedElementConstraintLinkSet;

interface AConstrainedElementConstraint : Reflective::RefAssociation
{
    AConstrainedElementConstraintLinkSet all_a_constrained_element_constraint_links()
        raises (Reflective::MofError);
    boolean exists (
        in ModelElement constrained_element,

```

5 UML CORBAfacility InterfaceDefinition

```
    in UmlConstraint uml_constraint)
    raises (Reflective::MofError);
ModelElementUList constrained_element (in UmlConstraint uml_constraint)
    raises (Reflective::MofError);
UmlConstraintSet uml_constraint (in ModelElement constrained_element)
    raises (Reflective::MofError);
void add (
    in ModelElement constrained_element,
    in UmlConstraint uml_constraint)
    raises (Reflective::MofError);
void add_before_constrained_element (
    in ModelElement constrained_element,
    in UmlConstraint uml_constraint,
    in ModelElement before)
    raises (Reflective::NotFound, Reflective::MofError);
void modify_constrained_element (
    in ModelElement constrained_element,
    in UmlConstraint uml_constraint,
    in ModelElement new_constrained_element)
    raises (Reflective::NotFound, Reflective::MofError);
void modify_uml_constraint (
    in ModelElement constrained_element,
    in UmlConstraint uml_constraint,
    in UmlConstraint new_uml_constraint)
    raises (Reflective::NotFound, Reflective::MofError);
void remove (
    in ModelElement constrained_element,
    in UmlConstraint uml_constraint)
    raises (Reflective::NotFound, Reflective::MofError);
}; // end of interface AConstrainedElementConstraint

struct ASupplierSupplierDependencyLink
{
    ModelElement supplier;
    Dependency supplier_dependency;
};
typedef sequence<ASupplierSupplierDependencyLink>
    ASupplierSupplierDependencyLinkSet;

interface ASupplierSupplierDependency : Reflective::RefAssociation
{
    ASupplierSupplierDependencyLinkSet all_a_supplier_supplier_dependency_links()
        raises (Reflective::MofError);
    boolean exists (
        in ModelElement supplier,
        in Dependency supplier_dependency)
        raises (Reflective::MofError);
    ModelElementSet supplier (in Dependency supplier_dependency)
        raises (Reflective::MofError);
    DependencySet supplier_dependency (in ModelElement supplier)
        raises (Reflective::MofError);
};
```



```

void add (
    in ModelElement supplier,
    in Dependency supplier_dependency)
    raises (Reflective::MofError);
void modify_supplier (
    in ModelElement supplier,
    in Dependency supplier_dependency,
    in ModelElement new_supplier)
    raises (Reflective::NotFound, Reflective::MofError);
void modify_supplier_dependency (
    in ModelElement supplier,
    in Dependency supplier_dependency,
    in Dependency new_supplier_dependency)
    raises (Reflective::NotFound, Reflective::MofError);
void remove (
    in ModelElement supplier,
    in Dependency supplier_dependency)
    raises (Reflective::NotFound, Reflective::MofError);
}; // end of interface ASupplierSupplierDependency

struct APresentationSubjectLink
{
    PresentationElement presentation;
    ModelElement subject;
};
typedef sequence<APresentationSubjectLink> APresentationSubjectLinkSet;

interface APresentationSubject : Reflective::RefAssociation
{
    APresentationSubjectLinkSet all_a_presentation_subject_links()
        raises (Reflective::MofError);
    boolean exists (
        in PresentationElement presentation,
        in ModelElement subject)
        raises (Reflective::MofError);
    PresentationElementSet presentation (in ModelElement subject)
        raises (Reflective::MofError);
    ModelElementSet subject (in PresentationElement presentation)
        raises (Reflective::MofError);
    void add (
        in PresentationElement presentation,
        in ModelElement subject)
        raises (Reflective::MofError);
    void modify_presentation (
        in PresentationElement presentation,
        in ModelElement subject,
        in PresentationElement new_presentation)
        raises (Reflective::NotFound, Reflective::MofError);
    void modify_subject (
        in PresentationElement presentation,
        in ModelElement subject,

```

5 UML CORBAfacility InterfaceDefinition

```
    in ModelElement new_subject)
    raises (Reflective::NotFound, Reflective::MofError);
void remove (
    in PresentationElement presentation,
    in ModelElement subject)
    raises (Reflective::NotFound, Reflective::MofError);
}; // end of interface APresentationSubject

struct ADeploymentLocationResidentLink
{
    Node deployment_location;
    Component resident;
};
typedef sequence<ADeploymentLocationResidentLink>
    ADeploymentLocationResidentLinkSet;

interface ADeploymentLocationResident : Reflective::RefAssociation
{
    ADeploymentLocationResidentLinkSet all_a_deployment_location_resident_links()
        raises (Reflective::MofError);
    boolean exists (
        in Node deployment_location,
        in Component resident)
        raises (Reflective::MofError);
    NodeSet deployment_location (in Component resident)
        raises (Reflective::MofError);
    ComponentSet resident (in Node deployment_location)
        raises (Reflective::MofError);
    void add (
        in Node deployment_location,
        in Component resident)
        raises (Reflective::MofError);
    void modify_deployment_location (
        in Node deployment_location,
        in Component resident,
        in Node new_deployment_location)
        raises (Reflective::NotFound, Reflective::MofError);
    void modify_resident (
        in Node deployment_location,
        in Component resident,
        in Component new_resident)
        raises (Reflective::NotFound, Reflective::MofError);
    void remove (
        in Node deployment_location,
        in Component resident)
        raises (Reflective::NotFound, Reflective::MofError);
}; // end of interface ADeploymentLocationResident

struct ATargetFlowTargetLink
{
    Flow target_flow;
```

```

    ModelElement target;
};
typedef sequence<ATargetFlowTargetLink> ATargetFlowTargetLinkSet;

interface ATargetFlowTarget : Reflective::RefAssociation
{
    ATargetFlowTargetLinkSet all_a_target_flow_target_links()
        raises (Reflective::MofError);
    boolean exists (
        in Flow target_flow,
        in ModelElement target)
        raises (Reflective::MofError);
    FlowSet target_flow (in ModelElement target)
        raises (Reflective::MofError);
    ModelElementSet target (in Flow target_flow)
        raises (Reflective::MofError);
    void add (
        in Flow target_flow,
        in ModelElement target)
        raises (Reflective::MofError);
    void modify_target_flow (
        in Flow target_flow,
        in ModelElement target,
        in Flow new_target_flow)
        raises (Reflective::NotFound, Reflective::MofError);
    void modify_target (
        in Flow target_flow,
        in ModelElement target,
        in ModelElement new_target)
        raises (Reflective::NotFound, Reflective::MofError);
    void remove (
        in Flow target_flow,
        in ModelElement target)
        raises (Reflective::NotFound, Reflective::MofError);
}; // end of interface ATargetFlowTarget

struct ASourceFlowSourceLink
{
    Flow source_flow;
    ModelElement source;
};
typedef sequence<ASourceFlowSourceLink> ASourceFlowSourceLinkSet;

interface ASourceFlowSource : Reflective::RefAssociation
{
    ASourceFlowSourceLinkSet all_a_source_flow_source_links()
        raises (Reflective::MofError);
    boolean exists (
        in Flow source_flow,
        in ModelElement source)
        raises (Reflective::MofError);
};

```

5 UML CORBAfacility InterfaceDefinition

```
FlowSet source_flow (in ModelElement source)
  raises (Reflective::MofError);
ModelElementSet source (in Flow source_flow)
  raises (Reflective::MofError);
void add (
  in Flow source_flow,
  in ModelElement source)
  raises (Reflective::MofError);
void modify_source_flow (
  in Flow source_flow,
  in ModelElement source,
  in Flow new_source_flow)
  raises (Reflective::NotFound, Reflective::MofError);
void modify_source (
  in Flow source_flow,
  in ModelElement source,
  in ModelElement new_source)
  raises (Reflective::NotFound, Reflective::MofError);
void remove (
  in Flow source_flow,
  in ModelElement source)
  raises (Reflective::NotFound, Reflective::MofError);
}; // end of interface ASourceFlowSource

struct ADefaultElementTemplateParameter3Link
{
  ModelElement default_element;
  TemplateParameter template_parameter3;
};
typedef sequence<ADefaultElementTemplateParameter3Link>
                          ADefaultElementTemplateParameter3LinkSet;

interface ADefaultElementTemplateParameter3 : Reflective::RefAssociation
{
  ADefaultElementTemplateParameter3LinkSet
                          all_a_default_element_template_parameter3_links()
    raises (Reflective::MofError);
boolean exists (
  in ModelElement default_element,
  in TemplateParameter template_parameter3)
  raises (Reflective::MofError);
ModelElement default_element (in TemplateParameter template_parameter3)
  raises (Reflective::MofError);
TemplateParameterSet template_parameter3 (in ModelElement default_element)
  raises (Reflective::MofError);
void add (
  in ModelElement default_element,
  in TemplateParameter template_parameter3)
  raises (Reflective::MofError);
void modify_default_element (
  in ModelElement default_element,
```

```

    in TemplateParameter template_parameter3,
    in ModelElement new_default_element)
    raises (Reflective::NotFound, Reflective::MofError);
void modify_template_parameter3 (
    in ModelElement default_element,
    in TemplateParameter template_parameter3,
    in TemplateParameter new_template_parameter3)
    raises (Reflective::NotFound, Reflective::MofError);
void remove (
    in ModelElement default_element,
    in TemplateParameter template_parameter3)
    raises (Reflective::NotFound, Reflective::MofError);
}; // end of interface ADefaultElementTemplateParameter3

struct ABindingArgumentLink
{
    Core::Binding binding;
    ModelElement argument;
};
typedef sequence<ABindingArgumentLink> ABindingArgumentLinkSet;

interface ABindingArgument : Reflective::RefAssociation
{
    ABindingArgumentLinkSet all_a_binding_argument_links()
        raises (Reflective::MofError);
    boolean exists (
        in Core::Binding binding,
        in ModelElement argument)
        raises (Reflective::MofError);
    Core::Binding binding (in ModelElement argument)
        raises (Reflective::MofError);
    ModelElementUList argument (in Core::Binding binding)
        raises (Reflective::MofError);
    void add (
        in Core::Binding binding,
        in ModelElement argument)
        raises (Reflective::MofError);
    void add_before_argument (
        in Core::Binding binding,
        in ModelElement argument,
        in ModelElement before)
        raises (Reflective::NotFound, Reflective::MofError);
    void modify_binding (
        in Core::Binding binding,
        in ModelElement argument,
        in Core::Binding new_binding)
        raises (Reflective::NotFound, Reflective::MofError);
    void modify_argument (
        in Core::Binding binding,
        in ModelElement argument,
        in ModelElement new_argument)

```

5 UML CORBAfacility InterfaceDefinition

```
    raises (Reflective::NotFound, Reflective::MofError);
void remove (
    in Core::Binding binding,
    in ModelElement argument)
    raises (Reflective::NotFound, Reflective::MofError);
}; // end of interface ABindingArgument

struct APowertypePowertypeRangeLink
{
    Classifier powertype;
    Generalization powertype_range;
};
typedef sequence<APowertypePowertypeRangeLink>
    APowertypePowertypeRangeLinkSet;

interface APowertypePowertypeRange : Reflective::RefAssociation
{
    APowertypePowertypeRangeLinkSet all_a_powertype_powertype_range_links()
        raises (Reflective::MofError);
    boolean exists (
        in Classifier powertype,
        in Generalization powertype_range)
        raises (Reflective::MofError);
    Classifier powertype (in Generalization powertype_range)
        raises (Reflective::MofError);
    GeneralizationSet powertype_range (in Classifier powertype)
        raises (Reflective::MofError);
    void add (
        in Classifier powertype,
        in Generalization powertype_range)
        raises (Reflective::MofError);
    void modify_powertype (
        in Classifier powertype,
        in Generalization powertype_range,
        in Classifier new_powertype)
        raises (Reflective::NotFound, Reflective::MofError);
    void modify_powertype_range (
        in Classifier powertype,
        in Generalization powertype_range,
        in Generalization new_powertype_range)
        raises (Reflective::NotFound, Reflective::MofError);
    void remove (
        in Classifier powertype,
        in Generalization powertype_range)
        raises (Reflective::NotFound, Reflective::MofError);
}; // end of interface APowertypePowertypeRange

struct ACommentAnnotatedElementLink
{
    Core::Comment comment;
    ModelElement annotated_element;
```

```

};
typedef sequence<ACommentAnnotatedElementLink>
    ACommentAnnotatedElementLinkSet;

interface ACommentAnnotatedElement : Reflective::RefAssociation
{
    ACommentAnnotatedElementLinkSet all_a_comment_annotated_element_links()
        raises (Reflective::MofError);
    boolean exists (
        in Core::Comment comment,
        in ModelElement annotated_element)
        raises (Reflective::MofError);
    CommentSet comment (in ModelElement annotated_element)
        raises (Reflective::MofError);
    ModelElementSet annotated_element (in Core::Comment comment)
        raises (Reflective::MofError);
    void add (
        in Core::Comment comment,
        in ModelElement annotated_element)
        raises (Reflective::MofError);
    void modify_comment (
        in Core::Comment comment,
        in ModelElement annotated_element,
        in Core::Comment new_comment)
        raises (Reflective::NotFound, Reflective::MofError);
    void modify_annotated_element (
        in Core::Comment comment,
        in ModelElement annotated_element,
        in ModelElement new_annotated_element)
        raises (Reflective::NotFound, Reflective::MofError);
    void remove (
        in Core::Comment comment,
        in ModelElement annotated_element)
        raises (Reflective::NotFound, Reflective::MofError);
}; // end of interface ACommentAnnotatedElement

struct AResidentElementResidenceLink
{
    ModelElement resident;
    ElementResidence element_residence;
};
typedef sequence<AResidentElementResidenceLink> AResidentElementResidenceLinkSet;

interface AResidentElementResidence : Reflective::RefAssociation
{
    AResidentElementResidenceLinkSet all_a_resident_element_residence_links()
        raises (Reflective::MofError);
    boolean exists (
        in ModelElement resident,
        in ElementResidence element_residence)
        raises (Reflective::MofError);
}

```

5 UML CORBAfacility InterfaceDefinition

```
ModelElement resident (in ElementResidence element_residence)
  raises (Reflective::MofError);
ElementResidenceSet element_residence (in ModelElement resident)
  raises (Reflective::MofError);
void add (
  in ModelElement resident,
  in ElementResidence element_residence)
  raises (Reflective::MofError);
void modify_resident (
  in ModelElement resident,
  in ElementResidence element_residence,
  in ModelElement new_resident)
  raises (Reflective::NotFound, Reflective::MofError);
void modify_element_residence (
  in ModelElement resident,
  in ElementResidence element_residence,
  in ElementResidence new_element_residence)
  raises (Reflective::NotFound, Reflective::MofError);
void remove (
  in ModelElement resident,
  in ElementResidence element_residence)
  raises (Reflective::NotFound, Reflective::MofError);
}; // end of interface AResidentElementResidence

struct AlplementationLocationResidentElementLink
{
  Component implementation_location;
  ElementResidence resident_element;
};
typedef sequence<AlplementationLocationResidentElementLink>
                    AlplementationLocationResidentElementLinkSet;

interface AlplementationLocationResidentElement : Reflective::RefAssociation
{
  AlplementationLocationResidentElementLinkSet
                    all_a_implementation_location_resident_element_links()
    raises (Reflective::MofError);
  boolean exists (
    in Component implementation_location,
    in ElementResidence resident_element)
    raises (Reflective::MofError);
  Component implementation_location (in ElementResidence resident_element)
    raises (Reflective::MofError);
  ElementResidenceSet resident_element (in Component implementation_location)
    raises (Reflective::MofError);
  void add (
    in Component implementation_location,
    in ElementResidence resident_element)
    raises (Reflective::MofError);
  void modify_implementation_location (
    in Component implementation_location,
```



```

    in ElementResidence resident_element,
    in Component new_implementation_location)
    raises (Reflective::NotFound, Reflective::MofError);
void modify_resident_element (
    in Component implementation_location,
    in ElementResidence resident_element,
    in ElementResidence new_resident_element)
    raises (Reflective::NotFound, Reflective::MofError);
void remove (
    in Component implementation_location,
    in ElementResidence resident_element)
    raises (Reflective::NotFound, Reflective::MofError);
}; // end of interface AImplementationLocationResidentElement

struct AModelElementTemplateParameterLink
{
    ModelElement model_element;
    TemplateParameter template_parameter;
};
typedef sequence<AModelElementTemplateParameterLink>
    AModelElementTemplateParameterLinkSet;

interface AModelElementTemplateParameter : Reflective::RefAssociation
{
    AModelElementTemplateParameterLinkSet
        all_a_model_element_template_parameter_links()
        raises (Reflective::MofError);
    boolean exists (
        in ModelElement model_element,
        in TemplateParameter template_parameter)
        raises (Reflective::MofError);
    ModelElement model_element (in TemplateParameter template_parameter)
        raises (Reflective::MofError);
    TemplateParameterUList template_parameter (in ModelElement model_element)
        raises (Reflective::MofError);
    void add (
        in ModelElement model_element,
        in TemplateParameter template_parameter)
        raises (Reflective::MofError);
    void add_before_template_parameter (
        in ModelElement model_element,
        in TemplateParameter template_parameter,
        in TemplateParameter before)
        raises (Reflective::NotFound, Reflective::MofError);
    void modify_model_element (
        in ModelElement model_element,
        in TemplateParameter template_parameter,
        in ModelElement new_model_element)
        raises (Reflective::NotFound, Reflective::MofError);
    void modify_template_parameter (
        in ModelElement model_element,

```

5 UML CORBAfacility InterfaceDefinition

```
    in TemplateParameter template_parameter,
    in TemplateParameter new_template_parameter)
    raises (Reflective::NotFound, Reflective::MofError);
void remove (
    in ModelElement model_element,
    in TemplateParameter template_parameter)
    raises (Reflective::NotFound, Reflective::MofError);
}; // end of interface AModelElementTemplateParameter

struct AModelElement2TemplateParameter2Link
{
    ModelElement model_element2;
    TemplateParameter template_parameter2;
};
typedef sequence<AModelElement2TemplateParameter2Link>
    AModelElement2TemplateParameter2LinkSet;

interface AModelElement2TemplateParameter2 : Reflective::RefAssociation
{
    AModelElement2TemplateParameter2LinkSet
        all_a_model_element2_template_parameter2_links()
        raises (Reflective::MofError);
    boolean exists (
        in ModelElement model_element2,
        in TemplateParameter template_parameter2)
        raises (Reflective::MofError);
    ModelElement model_element2 (in TemplateParameter template_parameter2)
        raises (Reflective::MofError);
    TemplateParameterSet template_parameter2 (in ModelElement model_element2)
        raises (Reflective::MofError);
    void add (
        in ModelElement model_element2,
        in TemplateParameter template_parameter2)
        raises (Reflective::MofError);
    void modify_model_element2 (
        in ModelElement model_element2,
        in TemplateParameter template_parameter2,
        in ModelElement new_model_element2)
        raises (Reflective::NotFound, Reflective::MofError);
    void modify_template_parameter2 (
        in ModelElement model_element2,
        in TemplateParameter template_parameter2,
        in TemplateParameter new_template_parameter2)
        raises (Reflective::NotFound, Reflective::MofError);
    void remove (
        in ModelElement model_element2,
        in TemplateParameter template_parameter2)
        raises (Reflective::NotFound, Reflective::MofError);
}; // end of interface AModelElement2TemplateParameter2

interface CorePackage : Reflective::RefPackage
```

```

{
  readonly attribute ClassifierClass classifier_ref;
  readonly attribute ClassClass class_ref;
  readonly attribute DataTypeClass data_type_ref;
  readonly attribute StructuralFeatureClass structural_feature_ref;
  readonly attribute NamespaceClass namespace_ref;
  readonly attribute AssociationEndClass association_end_ref;
  readonly attribute UmlInterfaceClass uml_interface_ref;
  readonly attribute UmlConstraintClass uml_constraint_ref;
  readonly attribute AssociationClass association_ref;
  readonly attribute ElementClass element_ref;
  readonly attribute GeneralizableElementClass generalizable_element_ref;
  readonly attribute UmlAttributeClass uml_attribute_ref;
  readonly attribute OperationClass operation_ref;
  readonly attribute ParameterClass parameter_ref;
  readonly attribute MethodClass method_ref;
  readonly attribute GeneralizationClass generalization_ref;
  readonly attribute UmlAssociationClassClass uml_association_class_ref;
  readonly attribute FeatureClass feature_ref;
  readonly attribute BehavioralFeatureClass behavioral_feature_ref;
  readonly attribute ModelElementClass model_element_ref;
  readonly attribute DependencyClass dependency_ref;
  readonly attribute AbstractionClass abstraction_ref;
  readonly attribute PresentationElementClass presentation_element_ref;
  readonly attribute UsageClass usage_ref;
  readonly attribute BindingClass binding_ref;
  readonly attribute ComponentClass component_ref;
  readonly attribute NodeClass node_ref;
  readonly attribute PermissionClass permission_ref;
  readonly attribute CommentClass comment_ref;
  readonly attribute FlowClass flow_ref;
  readonly attribute RelationshipClass relationship_ref;
  readonly attribute ElementResidenceClass element_residence_ref;
  readonly attribute TemplateParameterClass template_parameter_ref;
  readonly attribute AAssociationConnection a_association_connection_ref;
  readonly attribute AOwnerFeature a_owner_feature_ref;
  readonly attribute ASpecificationMethod a_specification_method_ref;
  readonly attribute AStructuralFeatureType a_structural_feature_type_ref;
  readonly attribute ANamespaceOwnedElement a_namespace_owned_element_ref;
  readonly attribute ABehavioralFeatureParameter a_behavioral_feature_parameter_ref;
  readonly attribute AParameterType a_parameter_type_ref;
  readonly attribute AChildGeneralization a_child_generalization_ref;
  readonly attribute AParentSpecialization a_parent_specialization_ref;
  readonly attribute AQualifierAssociationEnd a_qualifier_association_end_ref;
  readonly attribute ATypeAssociationEnd a_type_association_end_ref;
  readonly attribute AParticipantSpecification a_participant_specification_ref;
  readonly attribute AClientClientDependency a_client_client_dependency_ref;
  readonly attribute AConstrainedElementConstraint
      a_constrained_element_constraint_ref;
  readonly attribute ASupplierSupplierDependency a_supplier_supplier_dependency_ref;
  readonly attribute APresentationSubject a_presentation_subject_ref;

```

5 UML CORBAfacility InterfaceDefinition

```
    readonly attribute ADeploymentLocationResident a_deployment_location_resident_ref;
    readonly attribute ATargetFlowTarget a_target_flow_target_ref;
    readonly attribute ASourceFlowSource a_source_flow_source_ref;
    readonly attribute ADefaultElementTemplateParameter3
        a_default_element_template_parameter3_ref;
    readonly attribute ABindingArgument a_binding_argument_ref;
    readonly attribute APowertypePowertypeRange a_powertype_powertype_range_ref;
    readonly attribute ACommentAnnotatedElement a_comment_annotated_element_ref;
    readonly attribute AResidentElementResidence a_resident_element_residence_ref;
    readonly attribute AImplementationLocationResidentElement
        a_implementation_location_resident_element_ref;
    readonly attribute AModelElementTemplateParameter
        a_model_element_template_parameter_ref;
    readonly attribute AModelElement2TemplateParameter2
        a_model_element2_template_parameter2_ref;
};
}; // end of module Core

module ExtensionMechanisms
{
    interface StereotypeClass;
    interface Stereotype;
    typedef sequence<Stereotype> StereotypeSet;
    interface TaggedValueClass;
    interface TaggedValue;
    typedef sequence<TaggedValue> TaggedValueSet;
    interface ExtensionMechanismsPackage;

    interface StereotypeClass : Core::GeneralizableElementClass
    {
        readonly attribute StereotypeSet all_of_type_stereotype;
        readonly attribute StereotypeSet all_of_class_stereotype;
        Stereotype create_stereotype (
            in DataTypes::Name name,
            in DataTypes::VisibilityKind visibility,
            in boolean is_specification,
            in boolean is_root,
            in boolean is_leaf,
            in boolean is_abstract,
            in DataTypes::Geometry icon,
            in DataTypes::Name base_class)
            raises (Reflective::MofError);
    };

    interface Stereotype : StereotypeClass, Core::GeneralizableElement
    {
        DataTypes::Geometry icon ()
            raises (Reflective::MofError);
        void set_icon (in DataTypes::Geometry new_value)
            raises (Reflective::MofError);
        DataTypes::Name base_class ()
```

```

    raises (Reflective::MofError);
void set_base_class (in DataTypes::Name new_value)
    raises (Reflective::MofError);
TaggedValueSet required_tag ()
    raises (Reflective::MofError);
void set_required_tag (in TaggedValueSet new_value)
    raises (Reflective::MofError);
void add_required_tag (in TaggedValue new_element)
    raises (Reflective::MofError);
void modify_required_tag (
    in TaggedValue old_element,
    in TaggedValue new_element)
    raises (Reflective::NotFound, Reflective::MofError);
void remove_required_tag (in TaggedValue old_element)
    raises (Reflective::NotFound, Reflective::MofError);
Core::ModelElementSet extended_element ()
    raises (Reflective::MofError);
void set_extended_element (in Core::ModelElementSet new_value)
    raises (Reflective::MofError);
void add_extended_element (in Core::ModelElement new_element)
    raises (Reflective::MofError);
void modify_extended_element (
    in Core::ModelElement old_element,
    in Core::ModelElement new_element)
    raises (Reflective::NotFound, Reflective::MofError);
void remove_extended_element (in Core::ModelElement old_element)
    raises (Reflective::NotFound, Reflective::MofError);
Core::UmlConstraintSet stereotype_constraint ()
    raises (Reflective::MofError);
void set_stereotype_constraint (in Core::UmlConstraintSet new_value)
    raises (Reflective::MofError);
void add_stereotype_constraint (in Core::UmlConstraint new_element)
    raises (Reflective::MofError);
void modify_stereotype_constraint (
    in Core::UmlConstraint old_element,
    in Core::UmlConstraint new_element)
    raises (Reflective::NotFound, Reflective::MofError);
void remove_stereotype_constraint (in Core::UmlConstraint old_element)
    raises (Reflective::NotFound, Reflective::MofError);
}; // end of interface Stereotype

interface TaggedValueClass : Reflective::RefObject
{
    readonly attribute TaggedValueSet all_of_type_tagged_value;
    readonly attribute TaggedValueSet all_of_class_tagged_value;
    TaggedValue create_tagged_value (
        in DataTypes::Name tag,
        in string uml_value)
        raises (Reflective::MofError);
};

```

5 UML CORBAfacility InterfaceDefinition

```
interface TaggedValue : TaggedValueClass
{
    DataTypes::Name tag ()
        raises (Reflective::MofError);
    void set_tag (in DataTypes::Name new_value)
        raises (Reflective::MofError);
    string uml_value ()
        raises (Reflective::MofError);
    void set_uml_value (in string new_value)
        raises (Reflective::MofError);
    ExtensionMechanisms::Stereotype stereotype ()
        raises (Reflective::NotSet, Reflective::MofError);
    void set_stereotype (in ExtensionMechanisms::Stereotype new_value)
        raises (Reflective::MofError);
    void unset_stereotype ()
        raises (Reflective::MofError);
    Core::ModelElement model_element ()
        raises (Reflective::NotSet, Reflective::MofError);
    void set_model_element (in Core::ModelElement new_value)
        raises (Reflective::MofError);
    void unset_model_element ()
        raises (Reflective::MofError);
}; // end of interface TaggedValue

struct ARequiredTagStereotypeLink
{
    TaggedValue required_tag;
    ExtensionMechanisms::Stereotype stereotype;
};
typedef sequence<ARequiredTagStereotypeLink> ARequiredTagStereotypeLinkSet;

interface ARequiredTagStereotype : Reflective::RefAssociation
{
    ARequiredTagStereotypeLinkSet all_a_required_tag_stereotype_links()
        raises (Reflective::MofError);
    boolean exists (
        in TaggedValue required_tag,
        in ExtensionMechanisms::Stereotype stereotype)
        raises (Reflective::MofError);
    TaggedValueSet required_tag (in ExtensionMechanisms::Stereotype stereotype)
        raises (Reflective::MofError);
    ExtensionMechanisms::Stereotype stereotype (in TaggedValue required_tag)
        raises (Reflective::MofError);
    void add (
        in TaggedValue required_tag,
        in ExtensionMechanisms::Stereotype stereotype)
        raises (Reflective::MofError);
    void modify_required_tag (
        in TaggedValue required_tag,
        in ExtensionMechanisms::Stereotype stereotype,
        in TaggedValue new_required_tag)
```

```

    raises (Reflective::NotFound, Reflective::MofError);
void modify_stereotype (
    in TaggedValue required_tag,
    in ExtensionMechanisms::Stereotype stereotype,
    in ExtensionMechanisms::Stereotype new_stereotype)
    raises (Reflective::NotFound, Reflective::MofError);
void remove (
    in TaggedValue required_tag,
    in ExtensionMechanisms::Stereotype stereotype)
    raises (Reflective::NotFound, Reflective::MofError);
}; // end of interface ARequiredTagStereotype

struct AStereotypeExtendedElementLink
{
    ExtensionMechanisms::Stereotype stereotype;
    Core::ModelElement extended_element;
};
typedef sequence<AStereotypeExtendedElementLink>
    AStereotypeExtendedElementLinkSet;

interface AStereotypeExtendedElement : Reflective::RefAssociation
{
    AStereotypeExtendedElementLinkSet all_a_stereotype_extended_element_links()
        raises (Reflective::MofError);
    boolean exists (
        in ExtensionMechanisms::Stereotype stereotype,
        in Core::ModelElement extended_element)
        raises (Reflective::MofError);
    ExtensionMechanisms::Stereotype stereotype (in Core::ModelElement extended_element)
        raises (Reflective::MofError);
    Core::ModelElementSet extended_element (in ExtensionMechanisms::Stereotype
        stereotype)
        raises (Reflective::MofError);
    void add (
        in ExtensionMechanisms::Stereotype stereotype,
        in Core::ModelElement extended_element)
        raises (Reflective::MofError);
    void modify_stereotype (
        in ExtensionMechanisms::Stereotype stereotype,
        in Core::ModelElement extended_element,
        in ExtensionMechanisms::Stereotype new_stereotype)
        raises (Reflective::NotFound, Reflective::MofError);
    void modify_extended_element (
        in ExtensionMechanisms::Stereotype stereotype,
        in Core::ModelElement extended_element,
        in Core::ModelElement new_extended_element)
        raises (Reflective::NotFound, Reflective::MofError);
    void remove (
        in ExtensionMechanisms::Stereotype stereotype,
        in Core::ModelElement extended_element)
        raises (Reflective::NotFound, Reflective::MofError);
};

```

5 UML CORBAfacility InterfaceDefinition

```
}; // end of interface AStereotypeExtendedElement

struct AConstrainedElement2StereotypeConstraintLink
{
    Stereotype constrained_element2;
    Core::UmlConstraint stereotype_constraint;
};
typedef sequence<AConstrainedElement2StereotypeConstraintLink>
    AConstrainedElement2StereotypeConstraintLinkSet;

interface AConstrainedElement2StereotypeConstraint : Reflective::RefAssociation
{
    AConstrainedElement2StereotypeConstraintLinkSet
        all_a_constrained_element2_stereotype_constraint_links()

    raises (Reflective::MofError);
    boolean exists (
        in Stereotype constrained_element2,
        in Core::UmlConstraint stereotype_constraint)
        raises (Reflective::MofError);
    Stereotype constrained_element2 (in Core::UmlConstraint stereotype_constraint)
        raises (Reflective::MofError);
    Core::UmlConstraintSet stereotype_constraint (in Stereotype constrained_element2)
        raises (Reflective::MofError);
    void add (
        in Stereotype constrained_element2,
        in Core::UmlConstraint stereotype_constraint)
        raises (Reflective::MofError);
    void modify_constrained_element2 (
        in Stereotype constrained_element2,
        in Core::UmlConstraint stereotype_constraint,
        in Stereotype new_constrained_element2)
        raises (Reflective::NotFound, Reflective::MofError);
    void modify_stereotype_constraint (
        in Stereotype constrained_element2,
        in Core::UmlConstraint stereotype_constraint,
        in Core::UmlConstraint new_stereotype_constraint)
        raises (Reflective::NotFound, Reflective::MofError);
    void remove (
        in Stereotype constrained_element2,
        in Core::UmlConstraint stereotype_constraint)
        raises (Reflective::NotFound, Reflective::MofError);
}; // end of interface AConstrainedElement2StereotypeConstraint

struct AModelElementTaggedValueLink
{
    Core::ModelElement model_element;
    TaggedValue tagged_value;
};
typedef sequence<AModelElementTaggedValueLink> AModelElementTaggedValueLinkSet;
```



```

interface AModelElementTaggedValue : Reflective::RefAssociation
{
  AModelElementTaggedValueLinkSet all_a_model_element_tagged_value_links()
    raises (Reflective::MofError);
  boolean exists (
    in Core::ModelElement model_element,
    in TaggedValue tagged_value)
    raises (Reflective::MofError);
  Core::ModelElement model_element (in TaggedValue tagged_value)
    raises (Reflective::MofError);
  TaggedValueSet tagged_value (in Core::ModelElement model_element)
    raises (Reflective::MofError);
  void add (
    in Core::ModelElement model_element,
    in TaggedValue tagged_value)
    raises (Reflective::MofError);
  void modify_model_element (
    in Core::ModelElement model_element,
    in TaggedValue tagged_value,
    in Core::ModelElement new_model_element)
    raises (Reflective::NotFound, Reflective::MofError);
  void modify_tagged_value (
    in Core::ModelElement model_element,
    in TaggedValue tagged_value,
    in TaggedValue new_tagged_value)
    raises (Reflective::NotFound, Reflective::MofError);
  void remove (
    in Core::ModelElement model_element,
    in TaggedValue tagged_value)
    raises (Reflective::NotFound, Reflective::MofError);
}; // end of interface AModelElementTaggedValue

interface ExtensionMechanismsPackage : Reflective::RefPackage
{
  readonly attribute StereotypeClass stereotype_ref;
  readonly attribute TaggedValueClass tagged_value_ref;
  readonly attribute ARequiredTagStereotype a_required_tag_stereotype_ref;
  readonly attribute AStereotypeExtendedElement a_stereotype_extended_element_ref;
  readonly attribute AConstrainedElement2StereotypeConstraint
    a_constrained_element2_stereotype_constraint_ref;
  readonly attribute AModelElementTaggedValue a_model_element_tagged_value_ref;
};
}; // end of module ExtensionMechanisms

interface FoundationPackageFactory
{
  FoundationPackage create_foundation_package ()
    raises (Reflective::MofError);
};

interface FoundationPackage : Reflective::RefPackage

```

5 UML CORBAfacility InterfaceDefinition

```
{  
  readonly attribute DataTypes::DataTypesPackage data_types_ref;  
  readonly attribute Core::CorePackage core_ref;  
  readonly attribute ExtensionMechanisms::ExtensionMechanismsPackage  
    extension_mechanisms_ref;  
};  
};
```

5.4.3 BehavioralElements

```
#pragma prefix "org.omg.Uml"
#include "Reflective.idl"
#include "Foundation.idl"

module BehavioralElements
{
  typedef sequence<Foundation::Core::Classifier> ClassifierSet;
  typedef sequence<Foundation::Core::ModelElement> ModelElementSet;
  typedef sequence<Foundation::Core::BehavioralFeature> BehavioralFeatureSet;
  typedef sequence<Foundation::Core::Feature> FeatureSet;
  typedef sequence<Foundation::Core::Parameter> ParameterSet;
  typedef sequence<Foundation::Core::Parameter> ParameterUList;
  typedef sequence<Foundation::Core::UmlAttribute> UmlAttributeSet;
  interface BehavioralElementsPackage;

  module CommonBehavior
  {
    interface InstanceClass;
    interface Instance;
    typedef sequence<Instance> InstanceSet;
    interface SignalClass;
    interface Signal;
    typedef sequence<Signal> SignalSet;
    interface CreateActionClass;
    interface CreateAction;
    typedef sequence<CreateAction> CreateActionSet;
    interface DestroyActionClass;
    interface DestroyAction;
    typedef sequence<DestroyAction> DestroyActionSet;
    interface UninterpretedActionClass;
    interface UninterpretedAction;
    typedef sequence<UninterpretedAction> UninterpretedActionSet;
    interface ActionClass;
    interface Action;
    typedef sequence<Action> ActionSet;
    typedef sequence<Action> ActionUList;
    interface AttributeLinkClass;
    interface AttributeLink;
    typedef sequence<AttributeLink> AttributeLinkSet;
    interface LinkObjectClass;
    interface LinkObject;
    typedef sequence<LinkObject> LinkObjectSet;
    interface UmlObjectClass;
    interface UmlObject;
    typedef sequence<UmlObject> UmlObjectSet;
    interface DataValueClass;
    interface DataValue;
    typedef sequence<DataValue> DataValueSet;
  }
}
```

5 UML CORBAfacility InterfaceDefinition

```
interface CallActionClass;
interface CallAction;
typedef sequence<CallAction> CallActionSet;
interface SendActionClass;
interface SendAction;
typedef sequence<SendAction> SendActionSet;
interface ActionSequenceClass;
interface ActionSequence;
typedef sequence<ActionSequence> ActionSequenceSet;
interface ArgumentClass;
interface Argument;
typedef sequence<Argument> ArgumentSet;
typedef sequence<Argument> ArgumentUList;
interface ReceptionClass;
interface Reception;
typedef sequence<Reception> ReceptionSet;
interface LinkClass;
interface Link;
typedef sequence<Link> LinkSet;
interface LinkEndClass;
interface LinkEnd;
typedef sequence<LinkEnd> LinkEndSet;
interface ReturnActionClass;
interface ReturnAction;
typedef sequence<ReturnAction> ReturnActionSet;
interface TerminateActionClass;
interface TerminateAction;
typedef sequence<TerminateAction> TerminateActionSet;
interface StimulusClass;
interface Stimulus;
typedef sequence<Stimulus> StimulusSet;
interface UmlExceptionClass;
interface UmlException;
typedef sequence<UmlException> UmlExceptionSet;
interface ComponentInstanceClass;
interface ComponentInstance;
typedef sequence<ComponentInstance> ComponentInstanceSet;
interface NodeInstanceClass;
interface NodeInstance;
typedef sequence<NodeInstance> NodeInstanceSet;
interface CommonBehaviorPackage;

interface InstanceClass : Foundation::Core::ModelElementClass
{
    readonly attribute InstanceSet all_of_type_instance;
    readonly attribute InstanceSet all_of_class_instance;
    Instance create_instance (
        in Foundation::DataTypes::Name name,
        in Foundation::DataTypes::VisibilityKind visibility,
        in boolean is_specification)
        raises (Reflective::MofError);
}
```

```

};

interface Instance : InstanceClass, Foundation::Core::ModelElement
{
  ClassifierSet classifier ()
    raises (Reflective::MofError);
  void set_classifier (in ClassifierSet new_value)
    raises (Reflective::MofError);
  void add_classifier (in Foundation::Core::Classifier new_element)
    raises (Reflective::MofError);
  void modify_classifier (
    in Foundation::Core::Classifier old_element,
    in Foundation::Core::Classifier new_element)
    raises (Reflective::NotFound, Reflective::MofError);
  void remove_classifier (in Foundation::Core::Classifier old_element)
    raises (Reflective::NotFound, Reflective::MofError);
  AttributeLinkSet attribute_link ()
    raises (Reflective::MofError);
  void set_attribute_link (in AttributeLinkSet new_value)
    raises (Reflective::MofError);
  void add_attribute_link (in AttributeLink new_element)
    raises (Reflective::MofError);
  void modify_attribute_link (
    in AttributeLink old_element,
    in AttributeLink new_element)
    raises (Reflective::NotFound, Reflective::MofError);
  void remove_attribute_link (in AttributeLink old_element)
    raises (Reflective::NotFound, Reflective::MofError);
  LinkEndSet link_end ()
    raises (Reflective::MofError);
  void set_link_end (in LinkEndSet new_value)
    raises (Reflective::MofError);
  void add_link_end (in LinkEnd new_element)
    raises (Reflective::MofError);
  void modify_link_end (
    in LinkEnd old_element,
    in LinkEnd new_element)
    raises (Reflective::NotFound, Reflective::MofError);
  void remove_link_end (in LinkEnd old_element)
    raises (Reflective::NotFound, Reflective::MofError);
  AttributeLinkSet slot ()
    raises (Reflective::MofError);
  void set_slot (in AttributeLinkSet new_value)
    raises (Reflective::MofError);
  void unset_slot ()
    raises (Reflective::MofError);
  void add_slot (in AttributeLink new_element)
    raises (Reflective::MofError);
  void modify_slot (
    in AttributeLink old_element,
    in AttributeLink new_element)

```

5 UML CORBAfacility InterfaceDefinition

```
    raises (Reflective::NotFound, Reflective::MofError);
void remove_slot (in AttributeLink old_element)
    raises (Reflective::NotFound, Reflective::MofError);
StimulusSet stimulus1 ()
    raises (Reflective::MofError);
void set_stimulus1 (in StimulusSet new_value)
    raises (Reflective::MofError);
void add_stimulus1 (in Stimulus new_element)
    raises (Reflective::MofError);
void modify_stimulus1 (
    in Stimulus old_element,
    in Stimulus new_element)
    raises (Reflective::NotFound, Reflective::MofError);
void remove_stimulus1 (in Stimulus old_element)
    raises (Reflective::NotFound, Reflective::MofError);
StimulusSet stimulus3 ()
    raises (Reflective::MofError);
void set_stimulus3 (in StimulusSet new_value)
    raises (Reflective::MofError);
void add_stimulus3 (in Stimulus new_element)
    raises (Reflective::MofError);
void modify_stimulus3 (
    in Stimulus old_element,
    in Stimulus new_element)
    raises (Reflective::NotFound, Reflective::MofError);
void remove_stimulus3 (in Stimulus old_element)
    raises (Reflective::NotFound, Reflective::MofError);
ComponentInstance component_instance ()
    raises (Reflective::NotSet, Reflective::MofError);
void set_component_instance (in ComponentInstance new_value)
    raises (Reflective::MofError);
void unset_component_instance ()
    raises (Reflective::MofError);
StimulusSet stimulus2 ()
    raises (Reflective::MofError);
void set_stimulus2 (in StimulusSet new_value)
    raises (Reflective::MofError);
void add_stimulus2 (in Stimulus new_element)
    raises (Reflective::MofError);
void modify_stimulus2 (
    in Stimulus old_element,
    in Stimulus new_element)
    raises (Reflective::NotFound, Reflective::MofError);
void remove_stimulus2 (in Stimulus old_element)
    raises (Reflective::NotFound, Reflective::MofError);
}; // end of interface Instance

interface SignalClass : Foundation::Core::ClassifierClass
{
    readonly attribute SignalSet all_of_type_signal;
    readonly attribute SignalSet all_of_class_signal;
```

```

Signal create_signal (
    in Foundation::DataTypes::Name name,
    in Foundation::DataTypes::VisibilityKind visibility,
    in boolean is_specification,
    in boolean is_root,
    in boolean is_leaf,
    in boolean is_abstract)
    raises (Reflective::MofError);
};

interface Signal : SignalClass, Foundation::Core::Classifier
{
    ReceptionSet reception ()
        raises (Reflective::MofError);
    void set_reception (in ReceptionSet new_value)
        raises (Reflective::MofError);
    void unset_reception ()
        raises (Reflective::MofError);
    void add_reception (in CommonBehavior::Reception new_element)
        raises (Reflective::MofError);
    void modify_reception (
        in CommonBehavior::Reception old_element,
        in CommonBehavior::Reception new_element)
        raises (Reflective::NotFound, Reflective::MofError);
    void remove_reception (in CommonBehavior::Reception old_element)
        raises (Reflective::NotFound, Reflective::MofError);
    BehavioralFeatureSet uml_context ()
        raises (Reflective::MofError);
    void set_uml_context (in BehavioralFeatureSet new_value)
        raises (Reflective::MofError);
    void add_uml_context (in Foundation::Core::BehavioralFeature new_element)
        raises (Reflective::MofError);
    void modify_uml_context (
        in Foundation::Core::BehavioralFeature old_element,
        in Foundation::Core::BehavioralFeature new_element)
        raises (Reflective::NotFound, Reflective::MofError);
    void remove_uml_context (in Foundation::Core::BehavioralFeature old_element)
        raises (Reflective::NotFound, Reflective::MofError);
    SendActionSet send_action ()
        raises (Reflective::MofError);
    void set_send_action (in SendActionSet new_value)
        raises (Reflective::MofError);
    void add_send_action (in SendAction new_element)
        raises (Reflective::MofError);
    void modify_send_action (
        in SendAction old_element,
        in SendAction new_element)
        raises (Reflective::NotFound, Reflective::MofError);
    void remove_send_action (in SendAction old_element)
        raises (Reflective::NotFound, Reflective::MofError);
}; // end of interface Signal

```

5 UML CORBAfacility InterfaceDefinition

```
interface ActionClass : Foundation::Core::ModelElementClass
{
    readonly attribute ActionSet all_of_type_action;
    readonly attribute ActionSet all_of_class_action;
    Action create_action (
        in Foundation::DataTypes::Name name,
        in Foundation::DataTypes::VisibilityKind visibility,
        in boolean is_specification,
        in Foundation::DataTypes::IterationExpression recurrence,
        in Foundation::DataTypes::ObjectSetExpression target,
        in boolean is_asynchronous,
        in Foundation::DataTypes::ActionExpression script)
        raises (Reflective::MofError);
};

interface Action : ActionClass, Foundation::Core::ModelElement
{
    Foundation::DataTypes::IterationExpression recurrence ()
        raises (Reflective::MofError);
    void set_recurrence (in Foundation::DataTypes::IterationExpression new_value)
        raises (Reflective::MofError);
    Foundation::DataTypes::ObjectSetExpression target ()
        raises (Reflective::MofError);
    void set_target (in Foundation::DataTypes::ObjectSetExpression new_value)
        raises (Reflective::MofError);
    boolean is_asynchronous ()
        raises (Reflective::MofError);
    void set_is_asynchronous (in boolean new_value)
        raises (Reflective::MofError);
    Foundation::DataTypes::ActionExpression script ()
        raises (Reflective::MofError);
    void set_script (in Foundation::DataTypes::ActionExpression new_value)
        raises (Reflective::MofError);
    ArgumentUList actual_argument ()
        raises (Reflective::MofError);
    void set_actual_argument (in ArgumentUList new_value)
        raises (Reflective::MofError);
    void add_actual_argument (in Argument new_element)
        raises (Reflective::MofError);
    void add_actual_argument_before (
        in Argument new_element,
        in Argument before_element)
        raises (Reflective::NotFound, Reflective::MofError);
    void modify_actual_argument (
        in Argument old_element,
        in Argument new_element)
        raises (Reflective::NotFound, Reflective::MofError);
    void remove_actual_argument (in Argument old_element)
        raises (Reflective::NotFound, Reflective::MofError);
    ActionSequence action_sequence ()
}
```



```

    raises (Reflective::NotSet, Reflective::MofError);
void set_action_sequence (in ActionSequence new_value)
    raises (Reflective::MofError);
void unset_action_sequence ()
    raises (Reflective::MofError);
StimulusSet stimulus ()
    raises (Reflective::MofError);
void set_stimulus (in StimulusSet new_value)
    raises (Reflective::MofError);
void add_stimulus (in CommonBehavior::Stimulus new_element)
    raises (Reflective::MofError);
void modify_stimulus (
    in CommonBehavior::Stimulus old_element,
    in CommonBehavior::Stimulus new_element)
    raises (Reflective::NotFound, Reflective::MofError);
void remove_stimulus (in CommonBehavior::Stimulus old_element)
    raises (Reflective::NotFound, Reflective::MofError);
}; // end of interface Action

```

```

interface CreateActionClass : ActionClass
{
    readonly attribute CreateActionSet all_of_type_create_action;
    readonly attribute CreateActionSet all_of_class_create_action;
    CreateAction create_create_action (
        in Foundation::DataTypes::Name name,
        in Foundation::DataTypes::VisibilityKind visibility,
        in boolean is_specification,
        in Foundation::DataTypes::IterationExpression recurrence,
        in Foundation::DataTypes::ObjectSetExpression target,
        in boolean is_asynchronous,
        in Foundation::DataTypes::ActionExpression script)
        raises (Reflective::MofError);
};

```

```

interface CreateAction : CreateActionClass, Action
{
    Foundation::Core::Classifier instantiation ()
        raises (Reflective::MofError);
    void set_instantiation (in Foundation::Core::Classifier new_value)
        raises (Reflective::MofError);
}; // end of interface CreateAction

```

```

interface DestroyActionClass : ActionClass
{
    readonly attribute DestroyActionSet all_of_type_destroy_action;
    readonly attribute DestroyActionSet all_of_class_destroy_action;
    DestroyAction create_destroy_action (
        in Foundation::DataTypes::Name name,
        in Foundation::DataTypes::VisibilityKind visibility,
        in boolean is_specification,
        in Foundation::DataTypes::IterationExpression recurrence,

```

5 UML CORBAfacility InterfaceDefinition

```
    in Foundation::DataTypes::ObjectSetExpression target,
    in boolean is_asynchronous,
    in Foundation::DataTypes::ActionExpression script)
    raises (Reflective::MofError);
};

interface DestroyAction : DestroyActionClass, Action
{
}; // end of interface DestroyAction

interface UninterpretedActionClass : ActionClass
{
    readonly attribute UninterpretedActionSet all_of_type_uninterpreted_action;
    readonly attribute UninterpretedActionSet all_of_class_uninterpreted_action;
    UninterpretedAction create_uninterpreted_action (
        in Foundation::DataTypes::Name name,
        in Foundation::DataTypes::VisibilityKind visibility,
        in boolean is_specification,
        in Foundation::DataTypes::IterationExpression recurrence,
        in Foundation::DataTypes::ObjectSetExpression target,
        in boolean is_asynchronous,
        in Foundation::DataTypes::ActionExpression script)
        raises (Reflective::MofError);
};

interface UninterpretedAction : UninterpretedActionClass, Action
{
}; // end of interface UninterpretedAction

interface AttributeLinkClass : Foundation::Core::ModelElementClass
{
    readonly attribute AttributeLinkSet all_of_type_attribute_link;
    readonly attribute AttributeLinkSet all_of_class_attribute_link;
    AttributeLink create_attribute_link (
        in Foundation::DataTypes::Name name,
        in Foundation::DataTypes::VisibilityKind visibility,
        in boolean is_specification)
        raises (Reflective::MofError);
};

interface AttributeLink : AttributeLinkClass, Foundation::Core::ModelElement
{
    Foundation::Core::UmlAttribute uml_attribute ()
        raises (Reflective::MofError);
    void set_uml_attribute (in Foundation::Core::UmlAttribute new_value)
        raises (Reflective::MofError);
    CommonBehavior::Instance uml_value ()
        raises (Reflective::MofError);
    void set_uml_value (in CommonBehavior::Instance new_value)
        raises (Reflective::MofError);
    CommonBehavior::Instance instance ()
}
```

```

    raises (Reflective::MofError);
void set_instance (in CommonBehavior::Instance new_value)
    raises (Reflective::MofError);
LinkEnd link_end ()
    raises (Reflective::NotSet, Reflective::MofError);
void set_link_end (in LinkEnd new_value)
    raises (Reflective::MofError);
void unset_link_end ()
    raises (Reflective::MofError);
}; // end of interface AttributeLink

interface UmObjectClass : InstanceClass
{
    readonly attribute UmObjectSet all_of_type_uml_object;
    readonly attribute UmObjectSet all_of_class_uml_object;
    UmObject create_uml_object (
        in Foundation::DataTypes::Name name,
        in Foundation::DataTypes::VisibilityKind visibility,
        in boolean is_specification)
        raises (Reflective::MofError);
};

interface UmObject : UmObjectClass, Instance
{
}; // end of interface UmObject

interface LinkClass : Foundation::Core::ModelElementClass
{
    readonly attribute LinkSet all_of_type_link;
    readonly attribute LinkSet all_of_class_link;
    Link create_link (
        in Foundation::DataTypes::Name name,
        in Foundation::DataTypes::VisibilityKind visibility,
        in boolean is_specification)
        raises (Reflective::MofError);
};

interface Link : LinkClass, Foundation::Core::ModelElement
{
    Foundation::Core::Association association ()
        raises (Reflective::MofError);
    void set_association (in Foundation::Core::Association new_value)
        raises (Reflective::MofError);
    LinkEndSet connection ()
        raises (Reflective::MofError);
    void set_connection (in LinkEndSet new_value)
        raises (Reflective::MofError);
    void add_connection (in LinkEnd new_element)
        raises (Reflective::MofError);
    void modify_connection (
        in LinkEnd old_element,

```

5 UML CORBAfacility InterfaceDefinition

```
    in LinkEnd new_element)
    raises (Reflective::NotFound, Reflective::MofError);
void remove_connection (in LinkEnd old_element)
    raises (Reflective::NotFound, Reflective::MofError);
StimulusSet stimulus ()
    raises (Reflective::MofError);
void set_stimulus (in StimulusSet new_value)
    raises (Reflective::MofError);
void add_stimulus (in CommonBehavior::Stimulus new_element)
    raises (Reflective::MofError);
void modify_stimulus (
    in CommonBehavior::Stimulus old_element,
    in CommonBehavior::Stimulus new_element)
    raises (Reflective::NotFound, Reflective::MofError);
void remove_stimulus (in CommonBehavior::Stimulus old_element)
    raises (Reflective::NotFound, Reflective::MofError);
}; // end of interface Link
```

```
interface LinkObjectClass : UmIObjectClass, LinkClass
{
    readonly attribute LinkObjectSet all_of_type_link_object;
    readonly attribute LinkObjectSet all_of_class_link_object;
    LinkObject create_link_object (
        in Foundation::DataTypes::Name name,
        in Foundation::DataTypes::VisibilityKind visibility,
        in boolean is_specification)
        raises (Reflective::MofError);
};
```

```
interface LinkObject : LinkObjectClass, UmIObject, Link
{
}; // end of interface LinkObject
```

```
interface DataValueClass : InstanceClass
{
    readonly attribute DataValueSet all_of_type_data_value;
    readonly attribute DataValueSet all_of_class_data_value;
    DataValue create_data_value (
        in Foundation::DataTypes::Name name,
        in Foundation::DataTypes::VisibilityKind visibility,
        in boolean is_specification)
        raises (Reflective::MofError);
};
```

```
interface DataValue : DataValueClass, Instance
{
}; // end of interface DataValue
```

```
interface CallActionClass : ActionClass
{
    readonly attribute CallActionSet all_of_type_call_action;
```

```

readonly attribute CallActionSet all_of_class_call_action;
CallAction create_call_action (
  in Foundation::DataTypes::Name name,
  in Foundation::DataTypes::VisibilityKind visibility,
  in boolean is_specification,
  in Foundation::DataTypes::IterationExpression recurrence,
  in Foundation::DataTypes::ObjectSetExpression target,
  in boolean is_asynchronous,
  in Foundation::DataTypes::ActionExpression script)
  raises (Reflective::MofError);
};

interface CallAction : CallActionClass, Action
{
  Foundation::Core::Operation operation ()
    raises (Reflective::MofError);
  void set_operation (in Foundation::Core::Operation new_value)
    raises (Reflective::MofError);
}; // end of interface CallAction

interface SendActionClass : ActionClass
{
  readonly attribute SendActionSet all_of_type_send_action;
  readonly attribute SendActionSet all_of_class_send_action;
  SendAction create_send_action (
    in Foundation::DataTypes::Name name,
    in Foundation::DataTypes::VisibilityKind visibility,
    in boolean is_specification,
    in Foundation::DataTypes::IterationExpression recurrence,
    in Foundation::DataTypes::ObjectSetExpression target,
    in boolean is_asynchronous,
    in Foundation::DataTypes::ActionExpression script)
    raises (Reflective::MofError);
};

interface SendAction : SendActionClass, Action
{
  CommonBehavior::Signal signal ()
    raises (Reflective::MofError);
  void set_signal (in CommonBehavior::Signal new_value)
    raises (Reflective::MofError);
}; // end of interface SendAction

interface ActionSequenceClass : CommonBehavior::ActionClass
{
  readonly attribute ActionSequenceSet all_of_type_action_sequence;
  readonly attribute ActionSequenceSet all_of_class_action_sequence;
  ActionSequence create_action_sequence (
    in Foundation::DataTypes::Name name,
    in Foundation::DataTypes::VisibilityKind visibility,
    in boolean is_specification,

```

5 UML CORBAfacility InterfaceDefinition

```
        in Foundation::DataTypes::IterationExpression recurrence,
        in Foundation::DataTypes::ObjectSetExpression target,
        in boolean is_asynchronous,
        in Foundation::DataTypes::ActionExpression script)
        raises (Reflective::MofError);
};

interface ActionSequence : ActionSequenceClass, CommonBehavior::Action
{
    ActionUList action ()
        raises (Reflective::MofError);
    void set_action (in ActionUList new_value)
        raises (Reflective::MofError);
    void unset_action ()
        raises (Reflective::MofError);
    void add_action (in CommonBehavior::Action new_element)
        raises (Reflective::MofError);
    void add_action_before (
        in CommonBehavior::Action new_element,
        in CommonBehavior::Action before_element)
        raises (Reflective::NotFound, Reflective::MofError);
    void modify_action (
        in CommonBehavior::Action old_element,
        in CommonBehavior::Action new_element)
        raises (Reflective::NotFound, Reflective::MofError);
    void remove_action (in CommonBehavior::Action old_element)
        raises (Reflective::NotFound, Reflective::MofError);
}; // end of interface ActionSequence

interface ArgumentClass : Foundation::Core::ModelElementClass
{
    readonly attribute ArgumentSet all_of_type_argument;
    readonly attribute ArgumentSet all_of_class_argument;
    Argument create_argument (
        in Foundation::DataTypes::Name name,
        in Foundation::DataTypes::VisibilityKind visibility,
        in boolean is_specification,
        in Foundation::DataTypes::Expression uml_value)
        raises (Reflective::MofError);
};

interface Argument : ArgumentClass, Foundation::Core::ModelElement
{
    Foundation::DataTypes::Expression uml_value ()
        raises (Reflective::MofError);
    void set_uml_value (in Foundation::DataTypes::Expression new_value)
        raises (Reflective::MofError);
    CommonBehavior::Action action ()
        raises (Reflective::NotSet, Reflective::MofError);
    void set_action (in CommonBehavior::Action new_value)
        raises (Reflective::MofError);
};
```

```

    void unset_action ()
        raises (Reflective::MofError);
}; // end of interface Argument

interface ReceptionClass : Foundation::Core::BehavioralFeatureClass
{
    readonly attribute ReceptionSet all_of_type_reception;
    readonly attribute ReceptionSet all_of_class_reception;
    Reception create_reception (
        in Foundation::DataTypes::Name name,
        in Foundation::DataTypes::VisibilityKind visibility,
        in boolean is_specification,
        in Foundation::DataTypes::ScopeKind owner_scope,
        in boolean is_query,
        in string specification,
        in boolean is_root,
        in boolean is_leaf,
        in boolean is_abstract)
        raises (Reflective::MofError);
};

interface Reception : ReceptionClass, Foundation::Core::BehavioralFeature
{
    string specification ()
        raises (Reflective::MofError);
    void set_specification (in string new_value)
        raises (Reflective::MofError);
    boolean is_root ()
        raises (Reflective::MofError);
    void set_is_root (in boolean new_value)
        raises (Reflective::MofError);
    boolean is_leaf ()
        raises (Reflective::MofError);
    void set_is_leaf (in boolean new_value)
        raises (Reflective::MofError);
    boolean is_abstract ()
        raises (Reflective::MofError);
    void set_is_abstract (in boolean new_value)
        raises (Reflective::MofError);
    CommonBehavior::Signal signal ()
        raises (Reflective::MofError);
    void set_signal (in CommonBehavior::Signal new_value)
        raises (Reflective::MofError);
}; // end of interface Reception

interface LinkEndClass : Foundation::Core::ModelElementClass
{
    readonly attribute LinkEndSet all_of_type_link_end;
    readonly attribute LinkEndSet all_of_class_link_end;
    LinkEnd create_link_end (
        in Foundation::DataTypes::Name name,

```

5 UML CORBAfacility InterfaceDefinition

```
        in Foundation::DataTypes::VisibilityKind visibility,
        in boolean is_specification)
        raises (Reflective::MofError);
};

interface LinkEnd : LinkEndClass, Foundation::Core::ModelElement
{
    CommonBehavior::Instance instance ()
        raises (Reflective::MofError);
    void set_instance (in CommonBehavior::Instance new_value)
        raises (Reflective::MofError);
    CommonBehavior::Link link ()
        raises (Reflective::MofError);
    void set_link (in CommonBehavior::Link new_value)
        raises (Reflective::MofError);
    Foundation::Core::AssociationEnd association_end ()
        raises (Reflective::MofError);
    void set_association_end (in Foundation::Core::AssociationEnd new_value)
        raises (Reflective::MofError);
    AttributeLinkSet qualified_value ()
        raises (Reflective::MofError);
    void set_qualified_value (in AttributeLinkSet new_value)
        raises (Reflective::MofError);
    void unset_qualified_value ()
        raises (Reflective::MofError);
    void add_qualified_value (in AttributeLink new_element)
        raises (Reflective::MofError);
    void modify_qualified_value (
        in AttributeLink old_element,
        in AttributeLink new_element)
        raises (Reflective::NotFound, Reflective::MofError);
    void remove_qualified_value (in AttributeLink old_element)
        raises (Reflective::NotFound, Reflective::MofError);
}; // end of interface LinkEnd

interface ReturnActionClass : ActionClass
{
    readonly attribute ReturnActionSet all_of_type_return_action;
    readonly attribute ReturnActionSet all_of_class_return_action;
    ReturnAction create_return_action (
        in Foundation::DataTypes::Name name,
        in Foundation::DataTypes::VisibilityKind visibility,
        in boolean is_specification,
        in Foundation::DataTypes::IterationExpression recurrence,
        in Foundation::DataTypes::ObjectSetExpression target,
        in boolean is_asynchronous,
        in Foundation::DataTypes::ActionExpression script)
        raises (Reflective::MofError);
};

interface ReturnAction : ReturnActionClass, Action
```



```

{
}; // end of interface ReturnAction

interface TerminateActionClass : ActionClass
{
  readonly attribute TerminateActionSet all_of_type_terminate_action;
  readonly attribute TerminateActionSet all_of_class_terminate_action;
  TerminateAction create_terminate_action (
    in Foundation::DataTypes::Name name,
    in Foundation::DataTypes::VisibilityKind visibility,
    in boolean is_specification,
    in Foundation::DataTypes::IterationExpression recurrence,
    in Foundation::DataTypes::ObjectSetExpression target,
    in boolean is_asynchronous,
    in Foundation::DataTypes::ActionExpression script)
    raises (Reflective::MofError);
};

interface TerminateAction : TerminateActionClass, Action
{
}; // end of interface TerminateAction

interface StimulusClass : Foundation::Core::ModelElementClass
{
  readonly attribute StimulusSet all_of_type_stimulus;
  readonly attribute StimulusSet all_of_class_stimulus;
  Stimulus create_stimulus (
    in Foundation::DataTypes::Name name,
    in Foundation::DataTypes::VisibilityKind visibility,
    in boolean is_specification)
    raises (Reflective::MofError);
};

interface Stimulus : StimulusClass, Foundation::Core::ModelElement
{
  InstanceSet argument ()
    raises (Reflective::MofError);
  void set_argument (in InstanceSet new_value)
    raises (Reflective::MofError);
  void add_argument (in Instance new_element)
    raises (Reflective::MofError);
  void modify_argument (
    in Instance old_element,
    in Instance new_element)
    raises (Reflective::NotFound, Reflective::MofError);
  void remove_argument (in Instance old_element)
    raises (Reflective::NotFound, Reflective::MofError);
  Instance sender ()
    raises (Reflective::MofError);
  void set_sender (in Instance new_value)
    raises (Reflective::MofError);
};

```

5 UML CORBAfacility InterfaceDefinition

```
Instance receiver ()
  raises (Reflective::MofError);
void set_receiver (in Instance new_value)
  raises (Reflective::MofError);
Link communication_link ()
  raises (Reflective::NotSet, Reflective::MofError);
void set_communication_link (in Link new_value)
  raises (Reflective::MofError);
void unset_communication_link ()
  raises (Reflective::MofError);
Action dispatch_action ()
  raises (Reflective::MofError);
void set_dispatch_action (in Action new_value)
  raises (Reflective::MofError);
}; // end of interface Stimulus

interface UmIExceptionClass : SignalClass
{
  readonly attribute UmIExceptionSet all_of_type_umI_exception;
  readonly attribute UmIExceptionSet all_of_class_umI_exception;
  UmIException create_umI_exception (
    in Foundation::DataTypes::Name name,
    in Foundation::DataTypes::VisibilityKind visibility,
    in boolean is_specification,
    in boolean is_root,
    in boolean is_leaf,
    in boolean is_abstract)
    raises (Reflective::MofError);
};

interface UmIException : UmIExceptionClass, Signal
{
}; // end of interface UmIException

interface ComponentInstanceClass : InstanceClass
{
  readonly attribute ComponentInstanceSet all_of_type_component_instance;
  readonly attribute ComponentInstanceSet all_of_class_component_instance;
  ComponentInstance create_component_instance (
    in Foundation::DataTypes::Name name,
    in Foundation::DataTypes::VisibilityKind visibility,
    in boolean is_specification)
    raises (Reflective::MofError);
};

interface ComponentInstance : ComponentInstanceClass, Instance
{
  NodeInstance node_instance ()
    raises (Reflective::NotSet, Reflective::MofError);
  void set_node_instance (in NodeInstance new_value)
    raises (Reflective::MofError);
};
```

```

void unset_node_instance ()
    raises (Reflective::MofError);
InstanceSet resident ()
    raises (Reflective::MofError);
void set_resident (in InstanceSet new_value)
    raises (Reflective::MofError);
void add_resident (in Instance new_element)
    raises (Reflective::MofError);
void modify_resident (
    in Instance old_element,
    in Instance new_element)
    raises (Reflective::NotFound, Reflective::MofError);
void remove_resident (in Instance old_element)
    raises (Reflective::NotFound, Reflective::MofError);
}; // end of interface ComponentInstance

interface NodeInstanceClass : InstanceClass
{
    readonly attribute NodeInstanceSet all_of_type_node_instance;
    readonly attribute NodeInstanceSet all_of_class_node_instance;
    NodeInstance create_node_instance (
        in Foundation::DataTypes::Name name,
        in Foundation::DataTypes::VisibilityKind visibility,
        in boolean is_specification)
        raises (Reflective::MofError);
};

interface NodeInstance : NodeInstanceClass, Instance
{
    ComponentInstanceSet resident ()
        raises (Reflective::MofError);
    void set_resident (in ComponentInstanceSet new_value)
        raises (Reflective::MofError);
    void add_resident (in ComponentInstance new_element)
        raises (Reflective::MofError);
    void modify_resident (
        in ComponentInstance old_element,
        in ComponentInstance new_element)
        raises (Reflective::NotFound, Reflective::MofError);
    void remove_resident (in ComponentInstance old_element)
        raises (Reflective::NotFound, Reflective::MofError);
}; // end of interface NodeInstance

struct AInstanceClassifierLink
{
    CommonBehavior::Instance instance;
    Foundation::Core::Classifier classifier;
};
typedef sequence<AInstanceClassifierLink> AInstanceClassifierLinkSet;

interface AInstanceClassifier : Reflective::RefAssociation

```

5 UML CORBAfacility InterfaceDefinition

```
{
  AInstanceClassifierLinkSet all_a_instance_classifier_links()
    raises (Reflective::MofError);
  boolean exists (
    in CommonBehavior::Instance instance,
    in Foundation::Core::Classifier classifier)
    raises (Reflective::MofError);
  InstanceSet instance (in Foundation::Core::Classifier classifier)
    raises (Reflective::MofError);
  ClassifierSet classifier (in CommonBehavior::Instance instance)
    raises (Reflective::MofError);
  void add (
    in CommonBehavior::Instance instance,
    in Foundation::Core::Classifier classifier)
    raises (Reflective::MofError);
  void modify_instance (
    in CommonBehavior::Instance instance,
    in Foundation::Core::Classifier classifier,
    in CommonBehavior::Instance new_instance)
    raises (Reflective::NotFound, Reflective::MofError);
  void modify_classifier (
    in CommonBehavior::Instance instance,
    in Foundation::Core::Classifier classifier,
    in Foundation::Core::Classifier new_classifier)
    raises (Reflective::NotFound, Reflective::MofError);
  void remove (
    in CommonBehavior::Instance instance,
    in Foundation::Core::Classifier classifier)
    raises (Reflective::NotFound, Reflective::MofError);
}; // end of interface AInstanceClassifier

struct AActualArgumentActionLink
{
  Argument actual_argument;
  CommonBehavior::Action action;
};
typedef sequence<AActualArgumentActionLink> AActualArgumentActionLinkSet;

interface AActualArgumentAction : Reflective::RefAssociation
{
  AActualArgumentActionLinkSet all_a_actual_argument_action_links()
    raises (Reflective::MofError);
  boolean exists (
    in Argument actual_argument,
    in CommonBehavior::Action action)
    raises (Reflective::MofError);
  ArgumentUList actual_argument (in CommonBehavior::Action action)
    raises (Reflective::MofError);
  CommonBehavior::Action action (in Argument actual_argument)
    raises (Reflective::MofError);
  void add (
```

```

    in Argument actual_argument,
    in CommonBehavior::Action action)
    raises (Reflective::MofError);
void add_before_actual_argument (
    in Argument actual_argument,
    in CommonBehavior::Action action,
    in Argument before)
    raises (Reflective::NotFound, Reflective::MofError);
void modify_actual_argument (
    in Argument actual_argument,
    in CommonBehavior::Action action,
    in Argument new_actual_argument)
    raises (Reflective::NotFound, Reflective::MofError);
void modify_action (
    in Argument actual_argument,
    in CommonBehavior::Action action,
    in CommonBehavior::Action new_action)
    raises (Reflective::NotFound, Reflective::MofError);
void remove (
    in Argument actual_argument,
    in CommonBehavior::Action action)
    raises (Reflective::NotFound, Reflective::MofError);
}; // end of interface AActualArgumentAction

struct ACreateActionInstantiationLink
{
    CreateAction create_action;
    Foundation::Core::Classifier instantiation;
};
typedef sequence<ACreateActionInstantiationLink> ACreateActionInstantiationLinkSet;

interface ACreateActionInstantiation : Reflective::RefAssociation
{
    ACreateActionInstantiationLinkSet all_a_create_action_instantiation_links()
        raises (Reflective::MofError);
    boolean exists (
        in CreateAction create_action,
        in Foundation::Core::Classifier instantiation)
        raises (Reflective::MofError);
    CreateActionSet create_action (in Foundation::Core::Classifier instantiation)
        raises (Reflective::MofError);
    Foundation::Core::Classifier instantiation (in CreateAction create_action)
        raises (Reflective::MofError);
    void add (
        in CreateAction create_action,
        in Foundation::Core::Classifier instantiation)
        raises (Reflective::MofError);
    void modify_create_action (
        in CreateAction create_action,
        in Foundation::Core::Classifier instantiation,
        in CreateAction new_create_action)

```

5 UML CORBAfacility InterfaceDefinition

```
    raises (Reflective::NotFound, Reflective::MofError);
void modify_instantiation (
    in CreateAction create_action,
    in Foundation::Core::Classifier instantiation,
    in Foundation::Core::Classifier new_instantiation)
    raises (Reflective::NotFound, Reflective::MofError);
void remove (
    in CreateAction create_action,
    in Foundation::Core::Classifier instantiation)
    raises (Reflective::NotFound, Reflective::MofError);
}; // end of interface ACreateActionInstantiation

struct AAttributeLinkAttributeLink
{
    AttributeLink attribute_link;
    Foundation::Core::UmlAttribute uml_attribute;
};
typedef sequence<AAttributeLinkAttributeLink> AAttributeLinkAttributeLinkSet;

interface AAttributeLinkAttribute : Reflective::RefAssociation
{
    AAttributeLinkAttributeLinkSet all_a_attribute_link_attribute_links()
        raises (Reflective::MofError);
    boolean exists (
        in AttributeLink attribute_link,
        in Foundation::Core::UmlAttribute uml_attribute)
        raises (Reflective::MofError);
    AttributeLinkSet attribute_link (in Foundation::Core::UmlAttribute uml_attribute)
        raises (Reflective::MofError);
    Foundation::Core::UmlAttribute uml_attribute (in AttributeLink attribute_link)
        raises (Reflective::MofError);
    void add (
        in AttributeLink attribute_link,
        in Foundation::Core::UmlAttribute uml_attribute)
        raises (Reflective::MofError);
    void modify_attribute_link (
        in AttributeLink attribute_link,
        in Foundation::Core::UmlAttribute uml_attribute,
        in AttributeLink new_attribute_link)
        raises (Reflective::NotFound, Reflective::MofError);
    void modify_uml_attribute (
        in AttributeLink attribute_link,
        in Foundation::Core::UmlAttribute uml_attribute,
        in Foundation::Core::UmlAttribute new_uml_attribute)
        raises (Reflective::NotFound, Reflective::MofError);
    void remove (
        in AttributeLink attribute_link,
        in Foundation::Core::UmlAttribute uml_attribute)
        raises (Reflective::NotFound, Reflective::MofError);
}; // end of interface AAttributeLinkAttribute
```

```

struct AAttributeLinkValueLink
{
    AttributeLink attribute_link;
    Instance uml_value;
};
typedef sequence<AAttributeLinkValueLink> AAttributeLinkValueLinkSet;

interface AAttributeLinkValue : Reflective::RefAssociation
{
    AAttributeLinkValueLinkSet all_a_attribute_link_value_links()
        raises (Reflective::MofError);
    boolean exists (
        in AttributeLink attribute_link,
        in Instance uml_value)
        raises (Reflective::MofError);
    AttributeLinkSet attribute_link (in Instance uml_value)
        raises (Reflective::MofError);
    Instance uml_value (in AttributeLink attribute_link)
        raises (Reflective::MofError);
    void add (
        in AttributeLink attribute_link,
        in Instance uml_value)
        raises (Reflective::MofError);
    void modify_attribute_link (
        in AttributeLink attribute_link,
        in Instance uml_value,
        in AttributeLink new_attribute_link)
        raises (Reflective::NotFound, Reflective::MofError);
    void modify_uml_value (
        in AttributeLink attribute_link,
        in Instance uml_value,
        in Instance new_uml_value)
        raises (Reflective::NotFound, Reflective::MofError);
    void remove (
        in AttributeLink attribute_link,
        in Instance uml_value)
        raises (Reflective::NotFound, Reflective::MofError);
}; // end of interface AAttributeLinkValue

struct AInstanceLinkEndLink
{
    CommonBehavior::Instance instance;
    LinkEnd link_end;
};
typedef sequence<AInstanceLinkEndLink> AInstanceLinkEndLinkSet;

interface AInstanceLinkEnd : Reflective::RefAssociation
{
    AInstanceLinkEndLinkSet all_a_instance_link_end_links()
        raises (Reflective::MofError);
    boolean exists (

```

5 UML CORBAfacility InterfaceDefinition

```
    in CommonBehavior::Instance instance,
    in LinkEnd link_end)
    raises (Reflective::MofError);
CommonBehavior::Instance instance (in LinkEnd link_end)
    raises (Reflective::MofError);
LinkEndSet link_end (in CommonBehavior::Instance instance)
    raises (Reflective::MofError);
void add (
    in CommonBehavior::Instance instance,
    in LinkEnd link_end)
    raises (Reflective::MofError);
void modify_instance (
    in CommonBehavior::Instance instance,
    in LinkEnd link_end,
    in CommonBehavior::Instance new_instance)
    raises (Reflective::NotFound, Reflective::MofError);
void modify_link_end (
    in CommonBehavior::Instance instance,
    in LinkEnd link_end,
    in LinkEnd new_link_end)
    raises (Reflective::NotFound, Reflective::MofError);
void remove (
    in CommonBehavior::Instance instance,
    in LinkEnd link_end)
    raises (Reflective::NotFound, Reflective::MofError);
}; // end of interface AInstanceLinkEnd

struct ASignalReceptionLink
{
    CommonBehavior::Signal signal;
    CommonBehavior::Reception reception;
};
typedef sequence<ASignalReceptionLink> ASignalReceptionLinkSet;

interface ASignalReception : Reflective::RefAssociation
{
    ASignalReceptionLinkSet all_a_signal_reception_links()
        raises (Reflective::MofError);
    boolean exists (
        in CommonBehavior::Signal signal,
        in CommonBehavior::Reception reception)
        raises (Reflective::MofError);
    CommonBehavior::Signal signal (in CommonBehavior::Reception reception)
        raises (Reflective::MofError);
    ReceptionSet reception (in CommonBehavior::Signal signal)
        raises (Reflective::MofError);
    void add (
        in CommonBehavior::Signal signal,
        in CommonBehavior::Reception reception)
        raises (Reflective::MofError);
    void modify_signal (
```



```
    in CommonBehavior::Signal signal,
    in CommonBehavior::Reception reception,
    in CommonBehavior::Signal new_signal)
    raises (Reflective::NotFound, Reflective::MofError);
void modify_reception (
    in CommonBehavior::Signal signal,
    in CommonBehavior::Reception reception,
    in CommonBehavior::Reception new_reception)
    raises (Reflective::NotFound, Reflective::MofError);
void remove (
    in CommonBehavior::Signal signal,
    in CommonBehavior::Reception reception)
    raises (Reflective::NotFound, Reflective::MofError);
}; // end of interface ASignalReception

struct ASlotInstanceLink
{
    AttributeLink slot;
    CommonBehavior::Instance instance;
};
typedef sequence<ASlotInstanceLink> ASlotInstanceLinkSet;

interface ASlotInstance : Reflective::RefAssociation
{
    ASlotInstanceLinkSet all_a_slot_instance_links()
        raises (Reflective::MofError);
    boolean exists (
        in AttributeLink slot,
        in CommonBehavior::Instance instance)
        raises (Reflective::MofError);
    AttributeLinkSet slot (in CommonBehavior::Instance instance)
        raises (Reflective::MofError);
    CommonBehavior::Instance instance (in AttributeLink slot)
        raises (Reflective::MofError);
    void add (
        in AttributeLink slot,
        in CommonBehavior::Instance instance)
        raises (Reflective::MofError);
    void modify_slot (
        in AttributeLink slot,
        in CommonBehavior::Instance instance,
        in AttributeLink new_slot)
        raises (Reflective::NotFound, Reflective::MofError);
    void modify_instance (
        in AttributeLink slot,
        in CommonBehavior::Instance instance,
        in CommonBehavior::Instance new_instance)
        raises (Reflective::NotFound, Reflective::MofError);
    void remove (
        in AttributeLink slot,
        in CommonBehavior::Instance instance)
```

5 UML CORBAfacility InterfaceDefinition

```
    raises (Reflective::NotFound, Reflective::MofError);
}; // end of interface ASlotInstance

struct AArgumentStimulus1Link
{
    Instance argument;
    Stimulus stimulus1;
};
typedef sequence<AArgumentStimulus1Link> AArgumentStimulus1LinkSet;

interface AArgumentStimulus1 : Reflective::RefAssociation
{
    AArgumentStimulus1LinkSet all_a_argument_stimulus1_links()
        raises (Reflective::MofError);
    boolean exists (
        in Instance argument,
        in Stimulus stimulus1)
        raises (Reflective::MofError);
    InstanceSet argument (in Stimulus stimulus1)
        raises (Reflective::MofError);
    StimulusSet stimulus1 (in Instance argument)
        raises (Reflective::MofError);
    void add (
        in Instance argument,
        in Stimulus stimulus1)
        raises (Reflective::MofError);
    void modify_argument (
        in Instance argument,
        in Stimulus stimulus1,
        in Instance new_argument)
        raises (Reflective::NotFound, Reflective::MofError);
    void modify_stimulus1 (
        in Instance argument,
        in Stimulus stimulus1,
        in Stimulus new_stimulus1)
        raises (Reflective::NotFound, Reflective::MofError);
    void remove (
        in Instance argument,
        in Stimulus stimulus1)
        raises (Reflective::NotFound, Reflective::MofError);
}; // end of interface AArgumentStimulus1

struct AContextRaisedSignalLink
{
    Foundation::Core::BehavioralFeature uml_context;
    Signal raised_signal;
};
typedef sequence<AContextRaisedSignalLink> AContextRaisedSignalLinkSet;

interface AContextRaisedSignal : Reflective::RefAssociation
{
```

```

AContextRaisedSignalLinkSet all_a_context_raised_signal_links()
  raises (Reflective::MofError);
boolean exists (
  in Foundation::Core::BehavioralFeature uml_context,
  in Signal raised_signal)
  raises (Reflective::MofError);
BehavioralFeatureSet uml_context (in Signal raised_signal)
  raises (Reflective::MofError);
SignalSet raised_signal (in Foundation::Core::BehavioralFeature uml_context)
  raises (Reflective::MofError);
void add (
  in Foundation::Core::BehavioralFeature uml_context,
  in Signal raised_signal)
  raises (Reflective::MofError);
void modify_uml_context (
  in Foundation::Core::BehavioralFeature uml_context,
  in Signal raised_signal,
  in Foundation::Core::BehavioralFeature new_uml_context)
  raises (Reflective::NotFound, Reflective::MofError);
void modify_raised_signal (
  in Foundation::Core::BehavioralFeature uml_context,
  in Signal raised_signal,
  in Signal new_raised_signal)
  raises (Reflective::NotFound, Reflective::MofError);
void remove (
  in Foundation::Core::BehavioralFeature uml_context,
  in Signal raised_signal)
  raises (Reflective::NotFound, Reflective::MofError);
}; // end of interface AContextRaisedSignal

```

```

struct AAssociationLinkLink
{
  Foundation::Core::Association association;
  CommonBehavior::Link link;
};
typedef sequence<AAssociationLinkLink> AAssociationLinkLinkSet;

```

```

interface AAssociationLink : Reflective::RefAssociation
{
  AAssociationLinkLinkSet all_a_association_link_links()
    raises (Reflective::MofError);
boolean exists (
  in Foundation::Core::Association association,
  in CommonBehavior::Link link)
  raises (Reflective::MofError);
Foundation::Core::Association association (in CommonBehavior::Link link)
  raises (Reflective::MofError);
LinkSet link (in Foundation::Core::Association association)
  raises (Reflective::MofError);
void add (
  in Foundation::Core::Association association,

```

5 UML CORBAfacility InterfaceDefinition

```
    in CommonBehavior::Link link)
    raises (Reflective::MofError);
void modify_association (
    in Foundation::Core::Association association,
    in CommonBehavior::Link link,
    in Foundation::Core::Association new_association)
    raises (Reflective::NotFound, Reflective::MofError);
void modify_link (
    in Foundation::Core::Association association,
    in CommonBehavior::Link link,
    in CommonBehavior::Link new_link)
    raises (Reflective::NotFound, Reflective::MofError);
void remove (
    in Foundation::Core::Association association,
    in CommonBehavior::Link link)
    raises (Reflective::NotFound, Reflective::MofError);
}; // end of interface AAssociationLink

struct ALinkConnectionLink
{
    CommonBehavior::Link link;
    LinkEnd connection;
};
typedef sequence<ALinkConnectionLink> ALinkConnectionLinkSet;

interface ALinkConnection : Reflective::RefAssociation
{
    ALinkConnectionLinkSet all_a_link_connection_links()
        raises (Reflective::MofError);
    boolean exists (
        in CommonBehavior::Link link,
        in LinkEnd connection)
        raises (Reflective::MofError);
    CommonBehavior::Link link (in LinkEnd connection)
        raises (Reflective::MofError);
    LinkEndSet connection (in CommonBehavior::Link link)
        raises (Reflective::MofError);
    void add (
        in CommonBehavior::Link link,
        in LinkEnd connection)
        raises (Reflective::MofError);
    void modify_link (
        in CommonBehavior::Link link,
        in LinkEnd connection,
        in CommonBehavior::Link new_link)
        raises (Reflective::NotFound, Reflective::MofError);
    void modify_connection (
        in CommonBehavior::Link link,
        in LinkEnd connection,
        in LinkEnd new_connection)
        raises (Reflective::NotFound, Reflective::MofError);
};
```

```

void remove (
    in CommonBehavior::Link link,
    in LinkEnd connection)
    raises (Reflective::NotFound, Reflective::MofError);
}; // end of interface ALinkConnection

struct AAssociationEndLinkEndLink
{
    Foundation::Core::AssociationEnd association_end;
    LinkEnd link_end;
};
typedef sequence<AAssociationEndLinkEndLink> AAssociationEndLinkEndLinkSet;

interface AAssociationEndLinkEnd : Reflective::RefAssociation
{
    AAssociationEndLinkEndLinkSet all_a_association_end_link_end_links()
        raises (Reflective::MofError);
    boolean exists (
        in Foundation::Core::AssociationEnd association_end,
        in LinkEnd link_end)
        raises (Reflective::MofError);
    Foundation::Core::AssociationEnd association_end (in LinkEnd link_end)
        raises (Reflective::MofError);
    LinkEndSet link_end (in Foundation::Core::AssociationEnd association_end)
        raises (Reflective::MofError);
    void add (
        in Foundation::Core::AssociationEnd association_end,
        in LinkEnd link_end)
        raises (Reflective::MofError);
    void modify_association_end (
        in Foundation::Core::AssociationEnd association_end,
        in LinkEnd link_end,
        in Foundation::Core::AssociationEnd new_association_end)
        raises (Reflective::NotFound, Reflective::MofError);
    void modify_link_end (
        in Foundation::Core::AssociationEnd association_end,
        in LinkEnd link_end,
        in LinkEnd new_link_end)
        raises (Reflective::NotFound, Reflective::MofError);
    void remove (
        in Foundation::Core::AssociationEnd association_end,
        in LinkEnd link_end)
        raises (Reflective::NotFound, Reflective::MofError);
}; // end of interface AAssociationEndLinkEnd

struct AStimulus3SenderLink
{
    Stimulus stimulus3;
    Instance sender;
};
typedef sequence<AStimulus3SenderLink> AStimulus3SenderLinkSet;

```

5 UML CORBAfacility InterfaceDefinition

```
interface AStimulus3Sender : Reflective::RefAssociation
{
  AStimulus3SenderLinkSet all_a_stimulus3_sender_links()
    raises (Reflective::MofError);
  boolean exists (
    in Stimulus stimulus3,
    in Instance sender)
    raises (Reflective::MofError);
  StimulusSet stimulus3 (in Instance sender)
    raises (Reflective::MofError);
  Instance sender (in Stimulus stimulus3)
    raises (Reflective::MofError);
  void add (
    in Stimulus stimulus3,
    in Instance sender)
    raises (Reflective::MofError);
  void modify_stimulus3 (
    in Stimulus stimulus3,
    in Instance sender,
    in Stimulus new_stimulus3)
    raises (Reflective::NotFound, Reflective::MofError);
  void modify_sender (
    in Stimulus stimulus3,
    in Instance sender,
    in Instance new_sender)
    raises (Reflective::NotFound, Reflective::MofError);
  void remove (
    in Stimulus stimulus3,
    in Instance sender)
    raises (Reflective::NotFound, Reflective::MofError);
}; // end of interface AStimulus3Sender

struct ACallActionOperationLink
{
  CallAction call_action;
  Foundation::Core::Operation operation;
};
typedef sequence<ACallActionOperationLink> ACallActionOperationLinkSet;

interface ACallActionOperation : Reflective::RefAssociation
{
  ACallActionOperationLinkSet all_a_call_action_operation_links()
    raises (Reflective::MofError);
  boolean exists (
    in CallAction call_action,
    in Foundation::Core::Operation operation)
    raises (Reflective::MofError);
  CallActionSet call_action (in Foundation::Core::Operation operation)
    raises (Reflective::MofError);
  Foundation::Core::Operation operation (in CallAction call_action)
```

```

    raises (Reflective::MofError);
void add (
    in CallAction call_action,
    in Foundation::Core::Operation operation)
    raises (Reflective::MofError);
void modify_call_action (
    in CallAction call_action,
    in Foundation::Core::Operation operation,
    in CallAction new_call_action)
    raises (Reflective::NotFound, Reflective::MofError);
void modify_operation (
    in CallAction call_action,
    in Foundation::Core::Operation operation,
    in Foundation::Core::Operation new_operation)
    raises (Reflective::NotFound, Reflective::MofError);
void remove (
    in CallAction call_action,
    in Foundation::Core::Operation operation)
    raises (Reflective::NotFound, Reflective::MofError);
}; // end of interface ACallActionOperation

struct AActionSequenceActionLink
{
    ActionSequence action_sequence;
    CommonBehavior::Action action;
};
typedef sequence<AActionSequenceActionLink> AActionSequenceActionLinkSet;

interface AActionSequenceAction : Reflective::RefAssociation
{
    AActionSequenceActionLinkSet all_a_action_sequence_action_links()
        raises (Reflective::MofError);
    boolean exists (
        in ActionSequence action_sequence,
        in CommonBehavior::Action action)
        raises (Reflective::MofError);
    ActionSequence action_sequence (in CommonBehavior::Action action)
        raises (Reflective::MofError);
    ActionUList action (in ActionSequence action_sequence)
        raises (Reflective::MofError);
    void add (
        in ActionSequence action_sequence,
        in CommonBehavior::Action action)
        raises (Reflective::MofError);
    void add_before_action (
        in ActionSequence action_sequence,
        in CommonBehavior::Action action,
        in CommonBehavior::Action before)
        raises (Reflective::NotFound, Reflective::MofError);
    void modify_action_sequence (
        in ActionSequence action_sequence,

```

5 UML CORBAfacility InterfaceDefinition

```
    in CommonBehavior::Action action,
    in ActionSequence new_action_sequence)
    raises (Reflective::NotFound, Reflective::MofError);
void modify_action (
    in ActionSequence action_sequence,
    in CommonBehavior::Action action,
    in CommonBehavior::Action new_action)
    raises (Reflective::NotFound, Reflective::MofError);
void remove (
    in ActionSequence action_sequence,
    in CommonBehavior::Action action)
    raises (Reflective::NotFound, Reflective::MofError);
}; // end of interface AActionSequenceAction

struct AResidentNodeInstanceLink
{
    ComponentInstance resident;
    NodeInstance node_instance;
};
typedef sequence<AResidentNodeInstanceLink> AResidentNodeInstanceLinkSet;

interface AResidentNodeInstance : Reflective::RefAssociation
{
    AResidentNodeInstanceLinkSet all_a_resident_node_instance_links()
        raises (Reflective::MofError);
    boolean exists (
        in ComponentInstance resident,
        in NodeInstance node_instance)
        raises (Reflective::MofError);
    ComponentInstanceSet resident (in NodeInstance node_instance)
        raises (Reflective::MofError);
    NodeInstance node_instance (in ComponentInstance resident)
        raises (Reflective::MofError);
    void add (
        in ComponentInstance resident,
        in NodeInstance node_instance)
        raises (Reflective::MofError);
    void modify_resident (
        in ComponentInstance resident,
        in NodeInstance node_instance,
        in ComponentInstance new_resident)
        raises (Reflective::NotFound, Reflective::MofError);
    void modify_node_instance (
        in ComponentInstance resident,
        in NodeInstance node_instance,
        in NodeInstance new_node_instance)
        raises (Reflective::NotFound, Reflective::MofError);
    void remove (
        in ComponentInstance resident,
        in NodeInstance node_instance)
        raises (Reflective::NotFound, Reflective::MofError);
```



```

}; // end of interface AResidentNodeInstance

struct AResidentComponentInstanceLink
{
    Instance resident;
    ComponentInstance component_instance;
};
typedef sequence<AResidentComponentInstanceLink>
                    AResidentComponentInstanceLinkSet;

interface AResidentComponentInstance : Reflective::RefAssociation
{
    AResidentComponentInstanceLinkSet all_a_resident_component_instance_links()
        raises (Reflective::MofError);
    boolean exists (
        in Instance resident,
        in ComponentInstance component_instance)
        raises (Reflective::MofError);
    InstanceSet resident (in ComponentInstance component_instance)
        raises (Reflective::MofError);
    ComponentInstance component_instance (in Instance resident)
        raises (Reflective::MofError);
    void add (
        in Instance resident,
        in ComponentInstance component_instance)
        raises (Reflective::MofError);
    void modify_resident (
        in Instance resident,
        in ComponentInstance component_instance,
        in Instance new_resident)
        raises (Reflective::NotFound, Reflective::MofError);
    void modify_component_instance (
        in Instance resident,
        in ComponentInstance component_instance,
        in ComponentInstance new_component_instance)
        raises (Reflective::NotFound, Reflective::MofError);
    void remove (
        in Instance resident,
        in ComponentInstance component_instance)
        raises (Reflective::NotFound, Reflective::MofError);
}; // end of interface AResidentComponentInstance

struct AReceiverStimulus2Link
{
    Instance receiver;
    Stimulus stimulus2;
};
typedef sequence<AReceiverStimulus2Link> AReceiverStimulus2LinkSet;

interface AReceiverStimulus2 : Reflective::RefAssociation
{

```

5 UML CORBAfacility InterfaceDefinition

```
AReceiverStimulus2LinkSet all_a_receiver_stimulus2_links()
  raises (Reflective::MofError);
boolean exists (
  in Instance receiver,
  in Stimulus stimulus2)
  raises (Reflective::MofError);
Instance receiver (in Stimulus stimulus2)
  raises (Reflective::MofError);
StimulusSet stimulus2 (in Instance receiver)
  raises (Reflective::MofError);
void add (
  in Instance receiver,
  in Stimulus stimulus2)
  raises (Reflective::MofError);
void modify_receiver (
  in Instance receiver,
  in Stimulus stimulus2,
  in Instance new_receiver)
  raises (Reflective::NotFound, Reflective::MofError);
void modify_stimulus2 (
  in Instance receiver,
  in Stimulus stimulus2,
  in Stimulus new_stimulus2)
  raises (Reflective::NotFound, Reflective::MofError);
void remove (
  in Instance receiver,
  in Stimulus stimulus2)
  raises (Reflective::NotFound, Reflective::MofError);
}; // end of interface AReceiverStimulus2

struct AStimulusCommunicationLinkLink
{
  CommonBehavior::Stimulus stimulus;
  Link communication_link;
};
typedef sequence<AStimulusCommunicationLinkLink>
                    AStimulusCommunicationLinkLinkSet;

interface AStimulusCommunicationLink : Reflective::RefAssociation
{
  AStimulusCommunicationLinkLinkSet all_a_stimulus_communication_link_links()
    raises (Reflective::MofError);
boolean exists (
  in CommonBehavior::Stimulus stimulus,
  in Link communication_link)
  raises (Reflective::MofError);
StimulusSet stimulus (in Link communication_link)
  raises (Reflective::MofError);
Link communication_link (in CommonBehavior::Stimulus stimulus)
  raises (Reflective::MofError);
void add (
```

```

    in CommonBehavior::Stimulus stimulus,
    in Link communication_link)
    raises (Reflective::MofError);
void modify_stimulus (
    in CommonBehavior::Stimulus stimulus,
    in Link communication_link,
    in CommonBehavior::Stimulus new_stimulus)
    raises (Reflective::NotFound, Reflective::MofError);
void modify_communication_link (
    in CommonBehavior::Stimulus stimulus,
    in Link communication_link,
    in Link new_communication_link)
    raises (Reflective::NotFound, Reflective::MofError);
void remove (
    in CommonBehavior::Stimulus stimulus,
    in Link communication_link)
    raises (Reflective::NotFound, Reflective::MofError);
}; // end of interface AStimulusCommunicationLink

struct ADispatchActionStimulusLink
{
    Action dispatch_action;
    CommonBehavior::Stimulus stimulus;
};
typedef sequence<ADispatchActionStimulusLink> ADispatchActionStimulusLinkSet;

interface ADispatchActionStimulus : Reflective::RefAssociation
{
    ADispatchActionStimulusLinkSet all_a_dispatch_action_stimulus_links()
        raises (Reflective::MofError);
    boolean exists (
        in Action dispatch_action,
        in CommonBehavior::Stimulus stimulus)
        raises (Reflective::MofError);
    Action dispatch_action (in CommonBehavior::Stimulus stimulus)
        raises (Reflective::MofError);
    StimulusSet stimulus (in Action dispatch_action)
        raises (Reflective::MofError);
    void add (
        in Action dispatch_action,
        in CommonBehavior::Stimulus stimulus)
        raises (Reflective::MofError);
    void modify_dispatch_action (
        in Action dispatch_action,
        in CommonBehavior::Stimulus stimulus,
        in Action new_dispatch_action)
        raises (Reflective::NotFound, Reflective::MofError);
    void modify_stimulus (
        in Action dispatch_action,
        in CommonBehavior::Stimulus stimulus,
        in CommonBehavior::Stimulus new_stimulus)

```

5 UML CORBAfacility InterfaceDefinition

```
        raises (Reflective::NotFound, Reflective::MofError);
void remove (
    in Action dispatch_action,
    in CommonBehavior::Stimulus stimulus)
    raises (Reflective::NotFound, Reflective::MofError);
}; // end of interface ADispatchActionStimulus

struct ASignalSendActionLink
{
    CommonBehavior::Signal signal;
    SendAction send_action;
};
typedef sequence<ASignalSendActionLink> ASignalSendActionLinkSet;

interface ASignalSendAction : Reflective::RefAssociation
{
    ASignalSendActionLinkSet all_a_signal_send_action_links()
        raises (Reflective::MofError);
    boolean exists (
        in CommonBehavior::Signal signal,
        in SendAction send_action)
        raises (Reflective::MofError);
    CommonBehavior::Signal signal (in SendAction send_action)
        raises (Reflective::MofError);
    SendActionSet send_action (in CommonBehavior::Signal signal)
        raises (Reflective::MofError);
    void add (
        in CommonBehavior::Signal signal,
        in SendAction send_action)
        raises (Reflective::MofError);
    void modify_signal (
        in CommonBehavior::Signal signal,
        in SendAction send_action,
        in CommonBehavior::Signal new_signal)
        raises (Reflective::NotFound, Reflective::MofError);
    void modify_send_action (
        in CommonBehavior::Signal signal,
        in SendAction send_action,
        in SendAction new_send_action)
        raises (Reflective::NotFound, Reflective::MofError);
    void remove (
        in CommonBehavior::Signal signal,
        in SendAction send_action)
        raises (Reflective::NotFound, Reflective::MofError);
}; // end of interface ASignalSendAction

struct ALinkEndQualifiedValueLink
{
    LinkEnd link_end;
    AttributeLink qualified_value;
};
```

```
typedef sequence<ALinkEndQualifiedValueLink> ALinkEndQualifiedValueLinkSet;
```

```
interface ALinkEndQualifiedValue : Reflective::RefAssociation
{
  ALinkEndQualifiedValueLinkSet all_a_link_end_qualified_value_links()
    raises (Reflective::MofError);
  boolean exists (
    in LinkEnd link_end,
    in AttributeLink qualified_value)
    raises (Reflective::MofError);
  LinkEnd link_end (in AttributeLink qualified_value)
    raises (Reflective::MofError);
  AttributeLinkSet qualified_value (in LinkEnd link_end)
    raises (Reflective::MofError);
  void add (
    in LinkEnd link_end,
    in AttributeLink qualified_value)
    raises (Reflective::MofError);
  void modify_link_end (
    in LinkEnd link_end,
    in AttributeLink qualified_value,
    in LinkEnd new_link_end)
    raises (Reflective::NotFound, Reflective::MofError);
  void modify_qualified_value (
    in LinkEnd link_end,
    in AttributeLink qualified_value,
    in AttributeLink new_qualified_value)
    raises (Reflective::NotFound, Reflective::MofError);
  void remove (
    in LinkEnd link_end,
    in AttributeLink qualified_value)
    raises (Reflective::NotFound, Reflective::MofError);
}; // end of interface ALinkEndQualifiedValue
```

```
interface CommonBehaviorPackage : Reflective::RefPackage
{
  readonly attribute InstanceClass instance_ref;
  readonly attribute SignalClass signal_ref;
  readonly attribute CreateActionClass create_action_ref;
  readonly attribute DestroyActionClass destroy_action_ref;
  readonly attribute UninterpretedActionClass uninterpreted_action_ref;
  readonly attribute ActionClass action_ref;
  readonly attribute AttributeLinkClass attribute_link_ref;
  readonly attribute LinkObjectClass link_object_ref;
  readonly attribute UmIObjectClass uml_object_ref;
  readonly attribute DataValueClass data_value_ref;
  readonly attribute CallActionClass call_action_ref;
  readonly attribute SendActionClass send_action_ref;
  readonly attribute ActionSequenceClass action_sequence_ref;
  readonly attribute ArgumentClass argument_ref;
  readonly attribute ReceptionClass reception_ref;
```

5 UML CORBAfacility InterfaceDefinition

```
    readonly attribute LinkClass link_ref;
    readonly attribute LinkEndClass link_end_ref;
    readonly attribute ReturnActionClass return_action_ref;
    readonly attribute TerminateActionClass terminate_action_ref;
    readonly attribute StimulusClass stimulus_ref;
    readonly attribute UmlExceptionClass uml_exception_ref;
    readonly attribute ComponentInstanceClass component_instance_ref;
    readonly attribute NodeInstanceClass node_instance_ref;
    readonly attribute AInstanceClassifier a_instance_classifier_ref;
    readonly attribute AActualArgumentAction a_actual_argument_action_ref;
    readonly attribute ACreateActionInstantiation a_create_action_instantiation_ref;
    readonly attribute AAttributeLinkAttribute a_attribute_link_attribute_ref;
    readonly attribute AAttributeLinkValue a_attribute_link_value_ref;
    readonly attribute AInstanceLinkEnd a_instance_link_end_ref;
    readonly attribute ASignalReception a_signal_reception_ref;
    readonly attribute ASlotInstance a_slot_instance_ref;
    readonly attribute AArgumentStimulus1 a_argument_stimulus1_ref;
    readonly attribute AContextRaisedSignal a_context_raised_signal_ref;
    readonly attribute AAssociationLink a_association_link_ref;
    readonly attribute ALinkConnection a_link_connection_ref;
    readonly attribute AAssociationEndLinkEnd a_association_end_link_end_ref;
    readonly attribute AStimulus3Sender a_stimulus3_sender_ref;
    readonly attribute ACallActionOperation a_call_action_operation_ref;
    readonly attribute AActionSequenceAction a_action_sequence_action_ref;
    readonly attribute AResidentNodeInstance a_resident_node_instance_ref;
    readonly attribute AResidentComponentInstance a_resident_component_instance_ref;
    readonly attribute AReceiverStimulus2 a_receiver_stimulus2_ref;
    readonly attribute AStimulusCommunicationLink a_stimulus_communication_link_ref;
    readonly attribute ADispatchActionStimulus a_dispatch_action_stimulus_ref;
    readonly attribute ASignalSendAction a_signal_send_action_ref;
    readonly attribute ALinkEndQualifiedValue a_link_end_qualified_value_ref;
};
}; // end of module CommonBehavior

module UseCases
{
    interface UseCaseClass;
    interface UseCase;
    typedef sequence<UseCase> UseCaseSet;
    interface ActorClass;
    interface Actor;
    typedef sequence<Actor> ActorSet;
    interface UseCaseInstanceClass;
    interface UseCaseInstance;
    typedef sequence<UseCaseInstance> UseCaseInstanceSet;
    interface ExtendClass;
    interface Extend;
    typedef sequence<Extend> ExtendSet;
    interface IncludeClass;
    interface Include;
    typedef sequence<Include> IncludeSet;
```

```

interface ExtensionPointClass;
interface ExtensionPoint;
typedef sequence<ExtensionPoint> ExtensionPointSet;
typedef sequence<ExtensionPoint> ExtensionPointUList;
interface UseCasesPackage;

interface UseCaseClass : Foundation::Core::ClassifierClass
{
    readonly attribute UseCaseSet all_of_type_use_case;
    readonly attribute UseCaseSet all_of_class_use_case;
    UseCase create_use_case (
        in Foundation::DataTypes::Name name,
        in Foundation::DataTypes::VisibilityKind visibility,
        in boolean is_specification,
        in boolean is_root,
        in boolean is_leaf,
        in boolean is_abstract)
        raises (Reflective::MofError);
};

interface UseCase : UseCaseClass, Foundation::Core::Classifier
{
    ExtendSet extend2 ()
        raises (Reflective::MofError);
    void set_extend2 (in ExtendSet new_value)
        raises (Reflective::MofError);
    void add_extend2 (in UseCases::Extend new_element)
        raises (Reflective::MofError);
    void modify_extend2 (
        in UseCases::Extend old_element,
        in UseCases::Extend new_element)
        raises (Reflective::NotFound, Reflective::MofError);
    void remove_extend2 (in UseCases::Extend old_element)
        raises (Reflective::NotFound, Reflective::MofError);
    ExtendSet extend ()
        raises (Reflective::MofError);
    void set_extend (in ExtendSet new_value)
        raises (Reflective::MofError);
    void add_extend (in UseCases::Extend new_element)
        raises (Reflective::MofError);
    void modify_extend (
        in UseCases::Extend old_element,
        in UseCases::Extend new_element)
        raises (Reflective::NotFound, Reflective::MofError);
    void remove_extend (in UseCases::Extend old_element)
        raises (Reflective::NotFound, Reflective::MofError);
    IncludeSet include ()
        raises (Reflective::MofError);
    void set_include (in IncludeSet new_value)
        raises (Reflective::MofError);
    void add_include (in UseCases::Include new_element)

```

5 UML CORBAfacility InterfaceDefinition

```
    raises (Reflective::MofError);
void modify_include (
    in UseCases::Include old_element,
    in UseCases::Include new_element)
    raises (Reflective::NotFound, Reflective::MofError);
void remove_include (in UseCases::Include old_element)
    raises (Reflective::NotFound, Reflective::MofError);
IncludeSet include2 ()
    raises (Reflective::MofError);
void set_include2 (in IncludeSet new_value)
    raises (Reflective::MofError);
void add_include2 (in UseCases::Include new_element)
    raises (Reflective::MofError);
void modify_include2 (
    in UseCases::Include old_element,
    in UseCases::Include new_element)
    raises (Reflective::NotFound, Reflective::MofError);
void remove_include2 (in UseCases::Include old_element)
    raises (Reflective::NotFound, Reflective::MofError);
ExtensionPointSet extension_point ()
    raises (Reflective::MofError);
void set_extension_point (in ExtensionPointSet new_value)
    raises (Reflective::MofError);
void add_extension_point (in ExtensionPoint new_element)
    raises (Reflective::MofError);
void modify_extension_point (
    in ExtensionPoint old_element,
    in ExtensionPoint new_element)
    raises (Reflective::NotFound, Reflective::MofError);
void remove_extension_point (in ExtensionPoint old_element)
    raises (Reflective::NotFound, Reflective::MofError);
}; // end of interface UseCase

interface ActorClass : Foundation::Core::ClassifierClass
{
    readonly attribute ActorSet all_of_type_actor;
    readonly attribute ActorSet all_of_class_actor;
    Actor create_actor (
        in Foundation::DataTypes::Name name,
        in Foundation::DataTypes::VisibilityKind visibility,
        in boolean is_specification,
        in boolean is_root,
        in boolean is_leaf,
        in boolean is_abstract)
        raises (Reflective::MofError);
};

interface Actor : ActorClass, Foundation::Core::Classifier
{
}; // end of interface Actor
```



```

interface UseCaseInstanceClass : CommonBehavior::InstanceClass
{
    readonly attribute UseCaseInstanceSet all_of_type_use_case_instance;
    readonly attribute UseCaseInstanceSet all_of_class_use_case_instance;
    UseCaseInstance create_use_case_instance (
        in Foundation::DataTypes::Name name,
        in Foundation::DataTypes::VisibilityKind visibility,
        in boolean is_specification)
        raises (Reflective::MofError);
};

interface UseCaseInstance : UseCaseInstanceClass, CommonBehavior::Instance
{
}; // end of interface UseCaseInstance

interface ExtendClass : Foundation::Core::RelationshipClass
{
    readonly attribute ExtendSet all_of_type_extend;
    readonly attribute ExtendSet all_of_class_extend;
    Extend create_extend (
        in Foundation::DataTypes::Name name,
        in Foundation::DataTypes::VisibilityKind visibility,
        in boolean is_specification,
        in Foundation::DataTypes::BooleanExpression condition)
        raises (Reflective::MofError);
};

interface Extend : ExtendClass, Foundation::Core::Relationship
{
    Foundation::DataTypes::BooleanExpression condition ()
        raises (Reflective::MofError);
    void set_condition (in Foundation::DataTypes::BooleanExpression new_value)
        raises (Reflective::MofError);
    UseCase base ()
        raises (Reflective::MofError);
    void set_base (in UseCase new_value)
        raises (Reflective::MofError);
    UseCase extension ()
        raises (Reflective::MofError);
    void set_extension (in UseCase new_value)
        raises (Reflective::MofError);
    ExtensionPointUList extension_point ()
        raises (Reflective::MofError);
    void set_extension_point (in ExtensionPointUList new_value)
        raises (Reflective::MofError);
    void add_extension_point (in ExtensionPoint new_element)
        raises (Reflective::MofError);
    void add_extension_point_before (
        in ExtensionPoint new_element,
        in ExtensionPoint before_element)
        raises (Reflective::NotFound, Reflective::MofError);
};

```

5 UML CORBAfacility InterfaceDefinition

```
void modify_extension_point (
    in ExtensionPoint old_element,
    in ExtensionPoint new_element)
    raises (Reflective::NotFound, Reflective::MofError);
void remove_extension_point (in ExtensionPoint old_element)
    raises (Reflective::NotFound, Reflective::MofError);
}; // end of interface Extend

interface IncludeClass : Foundation::Core::RelationshipClass
{
    readonly attribute IncludeSet all_of_type_include;
    readonly attribute IncludeSet all_of_class_include;
    Include create_include (
        in Foundation::DataTypes::Name name,
        in Foundation::DataTypes::VisibilityKind visibility,
        in boolean is_specification)
        raises (Reflective::MofError);
};

interface Include : IncludeClass, Foundation::Core::Relationship
{
    UseCase addition ()
        raises (Reflective::MofError);
    void set_addition (in UseCase new_value)
        raises (Reflective::MofError);
    UseCase base ()
        raises (Reflective::MofError);
    void set_base (in UseCase new_value)
        raises (Reflective::MofError);
}; // end of interface Include

interface ExtensionPointClass : Foundation::Core::ModelElementClass
{
    readonly attribute ExtensionPointSet all_of_type_extension_point;
    readonly attribute ExtensionPointSet all_of_class_extension_point;
    ExtensionPoint create_extension_point (
        in Foundation::DataTypes::Name name,
        in Foundation::DataTypes::VisibilityKind visibility,
        in boolean is_specification,
        in Foundation::DataTypes::LocationReference location)
        raises (Reflective::MofError);
};

interface ExtensionPoint : ExtensionPointClass, Foundation::Core::ModelElement
{
    Foundation::DataTypes::LocationReference location ()
        raises (Reflective::MofError);
    void set_location (in Foundation::DataTypes::LocationReference new_value)
        raises (Reflective::MofError);
    UseCase use_case ()
        raises (Reflective::MofError);
};
```

```

void set_use_case (in UseCase new_value)
    raises (Reflective::MofError);
ExtendSet extend ()
    raises (Reflective::MofError);
void set_extend (in ExtendSet new_value)
    raises (Reflective::MofError);
void add_extend (in UseCases::Extend new_element)
    raises (Reflective::MofError);
void modify_extend (
    in UseCases::Extend old_element,
    in UseCases::Extend new_element)
    raises (Reflective::NotFound, Reflective::MofError);
void remove_extend (in UseCases::Extend old_element)
    raises (Reflective::NotFound, Reflective::MofError);
}; // end of interface ExtensionPoint

struct ABaseExtend2Link
{
    UseCase base;
    Extend extend2;
};
typedef sequence<ABaseExtend2Link> ABaseExtend2LinkSet;

interface ABaseExtend2 : Reflective::RefAssociation
{
    ABaseExtend2LinkSet all_a_base_extend2_links()
        raises (Reflective::MofError);
    boolean exists (
        in UseCase base,
        in Extend extend2)
        raises (Reflective::MofError);
    UseCase base (in Extend extend2)
        raises (Reflective::MofError);
    ExtendSet extend2 (in UseCase base)
        raises (Reflective::MofError);
    void add (
        in UseCase base,
        in Extend extend2)
        raises (Reflective::MofError);
    void modify_base (
        in UseCase base,
        in Extend extend2,
        in UseCase new_base)
        raises (Reflective::NotFound, Reflective::MofError);
    void modify_extend2 (
        in UseCase base,
        in Extend extend2,
        in Extend new_extend2)
        raises (Reflective::NotFound, Reflective::MofError);
    void remove (
        in UseCase base,

```

5 UML CORBAfacility InterfaceDefinition

```
        in Extend extend2)
        raises (Reflective::NotFound, Reflective::MofError);
}; // end of interface ABaseExtend2

struct AExtensionExtendLink
{
    UseCase extension;
    UseCases::Extend extend;
};
typedef sequence<AExtensionExtendLink> AExtensionExtendLinkSet;

interface AExtensionExtend : Reflective::RefAssociation
{
    AExtensionExtendLinkSet all_a_extension_extend_links()
        raises (Reflective::MofError);
    boolean exists (
        in UseCase extension,
        in UseCases::Extend extend)
        raises (Reflective::MofError);
    UseCase extension (in UseCases::Extend extend)
        raises (Reflective::MofError);
    ExtendSet extend (in UseCase extension)
        raises (Reflective::MofError);
    void add (
        in UseCase extension,
        in UseCases::Extend extend)
        raises (Reflective::MofError);
    void modify_extension (
        in UseCase extension,
        in UseCases::Extend extend,
        in UseCase new_extension)
        raises (Reflective::NotFound, Reflective::MofError);
    void modify_extend (
        in UseCase extension,
        in UseCases::Extend extend,
        in UseCases::Extend new_extend)
        raises (Reflective::NotFound, Reflective::MofError);
    void remove (
        in UseCase extension,
        in UseCases::Extend extend)
        raises (Reflective::NotFound, Reflective::MofError);
}; // end of interface AExtensionExtend

struct AlIncludeAdditionLink
{
    UseCases::Include include;
    UseCase addition;
};
typedef sequence<AlIncludeAdditionLink> AlIncludeAdditionLinkSet;

interface AlIncludeAddition : Reflective::RefAssociation
```

```

{
  AIncludeAdditionLinkSet all_a_include_addition_links()
    raises (Reflective::MofError);
  boolean exists (
    in UseCases::Include include,
    in UseCase addition)
    raises (Reflective::MofError);
  IncludeSet include (in UseCase addition)
    raises (Reflective::MofError);
  UseCase addition (in UseCases::Include include)
    raises (Reflective::MofError);
  void add (
    in UseCases::Include include,
    in UseCase addition)
    raises (Reflective::MofError);
  void modify_include (
    in UseCases::Include include,
    in UseCase addition,
    in UseCases::Include new_include)
    raises (Reflective::NotFound, Reflective::MofError);
  void modify_addition (
    in UseCases::Include include,
    in UseCase addition,
    in UseCase new_addition)
    raises (Reflective::NotFound, Reflective::MofError);
  void remove (
    in UseCases::Include include,
    in UseCase addition)
    raises (Reflective::NotFound, Reflective::MofError);
}; // end of interface AIncludeAddition

struct AInclude2BaseLink
{
  Include include2;
  UseCase base;
};
typedef sequence<AInclude2BaseLink> AInclude2BaseLinkSet;

interface AInclude2Base : Reflective::RefAssociation
{
  AInclude2BaseLinkSet all_a_include2_base_links()
    raises (Reflective::MofError);
  boolean exists (
    in Include include2,
    in UseCase base)
    raises (Reflective::MofError);
  IncludeSet include2 (in UseCase base)
    raises (Reflective::MofError);
  UseCase base (in Include include2)
    raises (Reflective::MofError);
  void add (

```

5 UML CORBAfacility InterfaceDefinition

```
    in Include include2,
    in UseCase base)
    raises (Reflective::MofError);
void modify_include2 (
    in Include include2,
    in UseCase base,
    in Include new_include2)
    raises (Reflective::NotFound, Reflective::MofError);
void modify_base (
    in Include include2,
    in UseCase base,
    in UseCase new_base)
    raises (Reflective::NotFound, Reflective::MofError);
void remove (
    in Include include2,
    in UseCase base)
    raises (Reflective::NotFound, Reflective::MofError);
}; // end of interface AInclude2Base

struct AExtensionPointUseCaseLink
{
    ExtensionPoint extension_point;
    UseCase use_case;
};
typedef sequence<AExtensionPointUseCaseLink> AExtensionPointUseCaseLinkSet;

interface AExtensionPointUseCase : Reflective::RefAssociation
{
    AExtensionPointUseCaseLinkSet all_a_extension_point_use_case_links()
        raises (Reflective::MofError);
    boolean exists (
        in ExtensionPoint extension_point,
        in UseCase use_case)
        raises (Reflective::MofError);
    ExtensionPointSet extension_point (in UseCase use_case)
        raises (Reflective::MofError);
    UseCase use_case (in ExtensionPoint extension_point)
        raises (Reflective::MofError);
    void add (
        in ExtensionPoint extension_point,
        in UseCase use_case)
        raises (Reflective::MofError);
    void modify_extension_point (
        in ExtensionPoint extension_point,
        in UseCase use_case,
        in ExtensionPoint new_extension_point)
        raises (Reflective::NotFound, Reflective::MofError);
    void modify_use_case (
        in ExtensionPoint extension_point,
        in UseCase use_case,
        in UseCase new_use_case)
```

```

        raises (Reflective::NotFound, Reflective::MofError);
void remove (
    in ExtensionPoint extension_point,
    in UseCase use_case)
    raises (Reflective::NotFound, Reflective::MofError);
}; // end of interface AExtensionPointUseCase

struct AExtensionPointExtendLink
{
    ExtensionPoint extension_point;
    UseCases::Extend extend;
};
typedef sequence<AExtensionPointExtendLink> AExtensionPointExtendLinkSet;

interface AExtensionPointExtend : Reflective::RefAssociation
{
    AExtensionPointExtendLinkSet all_a_extension_point_extend_links()
        raises (Reflective::MofError);
    boolean exists (
        in ExtensionPoint extension_point,
        in UseCases::Extend extend)
        raises (Reflective::MofError);
    ExtensionPointUList extension_point (in UseCases::Extend extend)
        raises (Reflective::MofError);
    ExtendSet extend (in ExtensionPoint extension_point)
        raises (Reflective::MofError);
    void add (
        in ExtensionPoint extension_point,
        in UseCases::Extend extend)
        raises (Reflective::MofError);
    void add_before_extension_point (
        in ExtensionPoint extension_point,
        in UseCases::Extend extend,
        in ExtensionPoint before)
        raises (Reflective::NotFound, Reflective::MofError);
    void modify_extension_point (
        in ExtensionPoint extension_point,
        in UseCases::Extend extend,
        in ExtensionPoint new_extension_point)
        raises (Reflective::NotFound, Reflective::MofError);
    void modify_extend (
        in ExtensionPoint extension_point,
        in UseCases::Extend extend,
        in UseCases::Extend new_extend)
        raises (Reflective::NotFound, Reflective::MofError);
    void remove (
        in ExtensionPoint extension_point,
        in UseCases::Extend extend)
        raises (Reflective::NotFound, Reflective::MofError);
}; // end of interface AExtensionPointExtend

```

5 UML CORBAfacility InterfaceDefinition

```
interface UseCasesPackage : Reflective::RefPackage
{
    readonly attribute UseCaseClass use_case_ref;
    readonly attribute ActorClass actor_ref;
    readonly attribute UseCaseInstanceClass use_case_instance_ref;
    readonly attribute ExtendClass extend_ref;
    readonly attribute IncludeClass include_ref;
    readonly attribute ExtensionPointClass extension_point_ref;
    readonly attribute ABaseExtend2 a_base_extend2_ref;
    readonly attribute AExtensionExtend a_extension_extend_ref;
    readonly attribute AIncludeAddition a_include_addition_ref;
    readonly attribute AInclude2Base a_include2_base_ref;
    readonly attribute AExtensionPointUseCase a_extension_point_use_case_ref;
    readonly attribute AExtensionPointExtend a_extension_point_extend_ref;
};
}; // end of module UseCases

module StateMachines
{
    interface StateMachineClass;
    interface StateMachine;
    typedef sequence<StateMachine> StateMachineSet;
    interface EventClass;
    interface Event;
    typedef sequence<Event> EventSet;
    interface StateClass;
    interface State;
    typedef sequence<State> StateSet;
    interface TimeEventClass;
    interface TimeEvent;
    typedef sequence<TimeEvent> TimeEventSet;
    interface CallEventClass;
    interface CallEvent;
    typedef sequence<CallEvent> CallEventSet;
    interface SignalEventClass;
    interface SignalEvent;
    typedef sequence<SignalEvent> SignalEventSet;
    interface TransitionClass;
    interface Transition;
    typedef sequence<Transition> TransitionSet;
    interface StateVertexClass;
    interface StateVertex;
    typedef sequence<StateVertex> StateVertexSet;
    interface CompositeStateClass;
    interface CompositeState;
    typedef sequence<CompositeState> CompositeStateSet;
    interface ChangeEventClass;
    interface ChangeEvent;
    typedef sequence<ChangeEvent> ChangeEventSet;
    interface GuardClass;
    interface Guard;
```



```

typedef sequence<Guard> GuardSet;
interface PseudostateClass;
interface Pseudostate;
typedef sequence<Pseudostate> PseudostateSet;
interface SimpleStateClass;
interface SimpleState;
typedef sequence<SimpleState> SimpleStateSet;
interface SubmachineStateClass;
interface SubmachineState;
typedef sequence<SubmachineState> SubmachineStateSet;
interface SynchStateClass;
interface SynchState;
typedef sequence<SynchState> SynchStateSet;
interface StubStateClass;
interface StubState;
typedef sequence<StubState> StubStateSet;
interface FinalStateClass;
interface FinalState;
typedef sequence<FinalState> FinalStateSet;
interface StateMachinesPackage;

interface StateMachineClass : Foundation::Core::ModelElementClass
{
    readonly attribute StateMachineSet all_of_type_state_machine;
    readonly attribute StateMachineSet all_of_class_state_machine;
    StateMachine create_state_machine (
        in Foundation::DataTypes::Name name,
        in Foundation::DataTypes::VisibilityKind visibility,
        in boolean is_specification)
        raises (Reflective::MofError);
};

interface StateMachine : StateMachineClass, Foundation::Core::ModelElement
{
    Foundation::Core::ModelElement uml_context ()
        raises (Reflective::NotSet, Reflective::MofError);
    void set_uml_context (in Foundation::Core::ModelElement new_value)
        raises (Reflective::MofError);
    void unset_uml_context ()
        raises (Reflective::MofError);
    State top ()
        raises (Reflective::MofError);
    void set_top (in State new_value)
        raises (Reflective::MofError);
    TransitionSet transitions ()
        raises (Reflective::MofError);
    void set_transitions (in TransitionSet new_value)
        raises (Reflective::MofError);
    void add_transitions (in Transition new_element)
        raises (Reflective::MofError);
    void modify_transitions (

```

5 UML CORBAfacility InterfaceDefinition

```
    in Transition old_element,
    in Transition new_element)
    raises (Reflective::NotFound, Reflective::MofError);
void remove_transitions (in Transition old_element)
    raises (Reflective::NotFound, Reflective::MofError);
SubmachineStateSet sub_machine_state ()
    raises (Reflective::MofError);
void set_sub_machine_state (in SubmachineStateSet new_value)
    raises (Reflective::MofError);
void add_sub_machine_state (in SubmachineState new_element)
    raises (Reflective::MofError);
void modify_sub_machine_state (
    in SubmachineState old_element,
    in SubmachineState new_element)
    raises (Reflective::NotFound, Reflective::MofError);
void remove_sub_machine_state (in SubmachineState old_element)
    raises (Reflective::NotFound, Reflective::MofError);
}; // end of interface StateMachine

interface EventClass : Foundation::Core::ModelElementClass
{
    readonly attribute EventSet all_of_type_event;
};

interface Event : EventClass, Foundation::Core::ModelElement
{
    ParameterUList parameter ()
        raises (Reflective::MofError);
void set_parameter (in ParameterUList new_value)
    raises (Reflective::MofError);
void unset_parameter ()
    raises (Reflective::MofError);
void add_parameter (in Foundation::Core::Parameter new_element)
    raises (Reflective::MofError);
void add_parameter_before (
    in Foundation::Core::Parameter new_element,
    in Foundation::Core::Parameter before_element)
    raises (Reflective::NotFound, Reflective::MofError);
void modify_parameter (
    in Foundation::Core::Parameter old_element,
    in Foundation::Core::Parameter new_element)
    raises (Reflective::NotFound, Reflective::MofError);
void remove_parameter (in Foundation::Core::Parameter old_element)
    raises (Reflective::NotFound, Reflective::MofError);
StateSet state ()
    raises (Reflective::MofError);
void set_state (in StateSet new_value)
    raises (Reflective::MofError);
void unset_state ()
    raises (Reflective::MofError);
void add_state (in StateMachines::State new_element)
```

```

    raises (Reflective::MofError);
void modify_state (
    in StateMachines::State old_element,
    in StateMachines::State new_element)
    raises (Reflective::NotFound, Reflective::MofError);
void remove_state (in StateMachines::State old_element)
    raises (Reflective::NotFound, Reflective::MofError);
TransitionSet transition ()
    raises (Reflective::MofError);
void set_transition (in TransitionSet new_value)
    raises (Reflective::MofError);
void add_transition (in StateMachines::Transition new_element)
    raises (Reflective::MofError);
void modify_transition (
    in StateMachines::Transition old_element,
    in StateMachines::Transition new_element)
    raises (Reflective::NotFound, Reflective::MofError);
void remove_transition (in StateMachines::Transition old_element)
    raises (Reflective::NotFound, Reflective::MofError);
}; // end of interface Event

interface StateVertexClass : Foundation::Core::ModelElementClass
{
    readonly attribute StateVertexSet all_of_type_state_vertex;
};

interface StateVertex : StateVertexClass, Foundation::Core::ModelElement
{
    CompositeState container ()
        raises (Reflective::NotSet, Reflective::MofError);
void set_container (in CompositeState new_value)
    raises (Reflective::MofError);
void unset_container ()
    raises (Reflective::MofError);
TransitionSet outgoing ()
    raises (Reflective::MofError);
void set_outgoing (in TransitionSet new_value)
    raises (Reflective::MofError);
void add_outgoing (in Transition new_element)
    raises (Reflective::MofError);
void modify_outgoing (
    in Transition old_element,
    in Transition new_element)
    raises (Reflective::NotFound, Reflective::MofError);
void remove_outgoing (in Transition old_element)
    raises (Reflective::NotFound, Reflective::MofError);
TransitionSet incoming ()
    raises (Reflective::MofError);
void set_incoming (in TransitionSet new_value)
    raises (Reflective::MofError);
void add_incoming (in Transition new_element)

```

5 UML CORBAfacility InterfaceDefinition

```
    raises (Reflective::MofError);
void modify_incoming (
    in Transition old_element,
    in Transition new_element)
    raises (Reflective::NotFound, Reflective::MofError);
void remove_incoming (in Transition old_element)
    raises (Reflective::NotFound, Reflective::MofError);
}; // end of interface StateVertex

interface StateClass : StateVertexClass
{
    readonly attribute StateSet all_of_type_state;
    readonly attribute StateSet all_of_class_state;
    State create_state (
        in Foundation::DataTypes::Name name,
        in Foundation::DataTypes::VisibilityKind visibility,
        in boolean is_specification)
        raises (Reflective::MofError);
};

interface State : StateClass, StateVertex
{
    CommonBehavior::Action entry ()
        raises (Reflective::NotSet, Reflective::MofError);
    void set_entry (in CommonBehavior::Action new_value)
        raises (Reflective::MofError);
    void unset_entry ()
        raises (Reflective::MofError);
    CommonBehavior::Action exit ()
        raises (Reflective::NotSet, Reflective::MofError);
    void set_exit (in CommonBehavior::Action new_value)
        raises (Reflective::MofError);
    void unset_exit ()
        raises (Reflective::MofError);
    StateMachine state_machine ()
        raises (Reflective::NotSet, Reflective::MofError);
    void set_state_machine (in StateMachine new_value)
        raises (Reflective::MofError);
    void unset_state_machine ()
        raises (Reflective::MofError);
    EventSet deferrable_event ()
        raises (Reflective::MofError);
    void set_deferrable_event (in EventSet new_value)
        raises (Reflective::MofError);
    void unset_deferrable_event ()
        raises (Reflective::MofError);
    void add_deferrable_event (in Event new_element)
        raises (Reflective::MofError);
    void modify_deferrable_event (
        in Event old_element,
        in Event new_element)
```

```

    raises (Reflective::NotFound, Reflective::MofError);
void remove_deferrable_event (in Event old_element)
    raises (Reflective::NotFound, Reflective::MofError);
TransitionSet internal_transition ()
    raises (Reflective::MofError);
void set_internal_transition (in TransitionSet new_value)
    raises (Reflective::MofError);
void add_internal_transition (in Transition new_element)
    raises (Reflective::MofError);
void modify_internal_transition (
    in Transition old_element,
    in Transition new_element)
    raises (Reflective::NotFound, Reflective::MofError);
void remove_internal_transition (in Transition old_element)
    raises (Reflective::NotFound, Reflective::MofError);
CommonBehavior::Action do_activity ()
    raises (Reflective::NotSet, Reflective::MofError);
void set_do_activity (in CommonBehavior::Action new_value)
    raises (Reflective::MofError);
void unset_do_activity ()
    raises (Reflective::MofError);
}; // end of interface State

interface TimeEventClass : EventClass
{
    readonly attribute TimeEventSet all_of_type_time_event;
    readonly attribute TimeEventSet all_of_class_time_event;
    TimeEvent create_time_event (
        in Foundation::DataTypes::Name name,
        in Foundation::DataTypes::VisibilityKind visibility,
        in boolean is_specification,
        in Foundation::DataTypes::TimeExpression when)
        raises (Reflective::MofError);
};

interface TimeEvent : TimeEventClass, Event
{
    Foundation::DataTypes::TimeExpression when ()
        raises (Reflective::MofError);
    void set_when (in Foundation::DataTypes::TimeExpression new_value)
        raises (Reflective::MofError);
}; // end of interface TimeEvent

interface CallEventClass : EventClass
{
    readonly attribute CallEventSet all_of_type_call_event;
    readonly attribute CallEventSet all_of_class_call_event;
    CallEvent create_call_event (
        in Foundation::DataTypes::Name name,
        in Foundation::DataTypes::VisibilityKind visibility,
        in boolean is_specification)

```

5 UML CORBAfacility InterfaceDefinition

```
        raises (Reflective::MofError);
};

interface CallEvent : CallEventClass, Event
{
    Foundation::Core::Operation operation ()
        raises (Reflective::MofError);
    void set_operation (in Foundation::Core::Operation new_value)
        raises (Reflective::MofError);
}; // end of interface CallEvent

interface SignalEventClass : EventClass
{
    readonly attribute SignalEventSet all_of_type_signal_event;
    readonly attribute SignalEventSet all_of_class_signal_event;
    SignalEvent create_signal_event (
        in Foundation::DataTypes::Name name,
        in Foundation::DataTypes::VisibilityKind visibility,
        in boolean is_specification)
        raises (Reflective::MofError);
};

interface SignalEvent : SignalEventClass, Event
{
    CommonBehavior::Signal signal ()
        raises (Reflective::MofError);
    void set_signal (in CommonBehavior::Signal new_value)
        raises (Reflective::MofError);
}; // end of interface SignalEvent

interface TransitionClass : Foundation::Core::ModelElementClass
{
    readonly attribute TransitionSet all_of_type_transition;
    readonly attribute TransitionSet all_of_class_transition;
    Transition create_transition (
        in Foundation::DataTypes::Name name,
        in Foundation::DataTypes::VisibilityKind visibility,
        in boolean is_specification)
        raises (Reflective::MofError);
};

interface Transition : TransitionClass, Foundation::Core::ModelElement
{
    StateMachines::Guard guard ()
        raises (Reflective::NotSet, Reflective::MofError);
    void set_guard (in StateMachines::Guard new_value)
        raises (Reflective::MofError);
    void unset_guard ()
        raises (Reflective::MofError);
    CommonBehavior::Action effect ()
        raises (Reflective::NotSet, Reflective::MofError);
};
```

```

void set_effect (in CommonBehavior::Action new_value)
    raises (Reflective::MofError);
void unset_effect ()
    raises (Reflective::MofError);
StateMachines::State state ()
    raises (Reflective::NotSet, Reflective::MofError);
void set_state (in StateMachines::State new_value)
    raises (Reflective::MofError);
void unset_state ()
    raises (Reflective::MofError);
Event trigger ()
    raises (Reflective::NotSet, Reflective::MofError);
void set_trigger (in Event new_value)
    raises (Reflective::MofError);
void unset_trigger ()
    raises (Reflective::MofError);
StateMachine state_machine ()
    raises (Reflective::NotSet, Reflective::MofError);
void set_state_machine (in StateMachine new_value)
    raises (Reflective::MofError);
void unset_state_machine ()
    raises (Reflective::MofError);
StateVertex source ()
    raises (Reflective::MofError);
void set_source (in StateVertex new_value)
    raises (Reflective::MofError);
StateVertex target ()
    raises (Reflective::MofError);
void set_target (in StateVertex new_value)
    raises (Reflective::MofError);
}; // end of interface Transition

interface CompositeStateClass : StateClass
{
    readonly attribute CompositeStateSet all_of_type_composite_state;
    readonly attribute CompositeStateSet all_of_class_composite_state;
    CompositeState create_composite_state (
        in Foundation::DataTypes::Name name,
        in Foundation::DataTypes::VisibilityKind visibility,
        in boolean is_specification,
        in boolean is_concurrent)
        raises (Reflective::MofError);
};

interface CompositeState : CompositeStateClass, State
{
    boolean is_concurrent ()
        raises (Reflective::MofError);
    void set_is_concurrent (in boolean new_value)
        raises (Reflective::MofError);
    StateVertexSet subvertex ()

```

5 UML CORBAfacility InterfaceDefinition

```
    raises (Reflective::MofError);
void set_subvertex (in StateVertexSet new_value)
    raises (Reflective::MofError);
void unset_subvertex ()
    raises (Reflective::MofError);
void add_subvertex (in StateVertex new_element)
    raises (Reflective::MofError);
void modify_subvertex (
    in StateVertex old_element,
    in StateVertex new_element)
    raises (Reflective::NotFound, Reflective::MofError);
void remove_subvertex (in StateVertex old_element)
    raises (Reflective::NotFound, Reflective::MofError);
}; // end of interface CompositeState

interface ChangeEventClass : EventClass
{
    readonly attribute ChangeEventSet all_of_type_change_event;
    readonly attribute ChangeEventSet all_of_class_change_event;
    ChangeEvent create_change_event (
        in Foundation::DataTypes::Name name,
        in Foundation::DataTypes::VisibilityKind visibility,
        in boolean is_specification,
        in Foundation::DataTypes::BooleanExpression change_expression)
        raises (Reflective::MofError);
};

interface ChangeEvent : ChangeEventClass, Event
{
    Foundation::DataTypes::BooleanExpression change_expression ()
        raises (Reflective::MofError);
    void set_change_expression (in Foundation::DataTypes::BooleanExpression new_value)
        raises (Reflective::MofError);
}; // end of interface ChangeEvent

interface GuardClass : Foundation::Core::ModelElementClass
{
    readonly attribute GuardSet all_of_type_guard;
    readonly attribute GuardSet all_of_class_guard;
    Guard create_guard (
        in Foundation::DataTypes::Name name,
        in Foundation::DataTypes::VisibilityKind visibility,
        in boolean is_specification,
        in Foundation::DataTypes::BooleanExpression expression)
        raises (Reflective::MofError);
};

interface Guard : GuardClass, Foundation::Core::ModelElement
{
    Foundation::DataTypes::BooleanExpression expression ()
        raises (Reflective::MofError);
};
```



```

void set_expression (in Foundation::DataTypes::BooleanExpression new_value)
    raises (Reflective::MofError);
StateMachines::Transition transition ()
    raises (Reflective::MofError);
void set_transition (in StateMachines::Transition new_value)
    raises (Reflective::MofError);
}; // end of interface Guard

```

```

interface PseudostateClass : StateVertexClass
{
    readonly attribute PseudostateSet all_of_type_pseudostate;
    readonly attribute PseudostateSet all_of_class_pseudostate;
    Pseudostate create_pseudostate (
        in Foundation::DataTypes::Name name,
        in Foundation::DataTypes::VisibilityKind visibility,
        in boolean is_specification,
        in Foundation::DataTypes::PseudostateKind kind)
        raises (Reflective::MofError);
};

```

```

interface Pseudostate : PseudostateClass, StateVertex
{
    Foundation::DataTypes::PseudostateKind kind ()
        raises (Reflective::MofError);
    void set_kind (in Foundation::DataTypes::PseudostateKind new_value)
        raises (Reflective::MofError);
}; // end of interface Pseudostate

```

```

interface SimpleStateClass : StateClass
{
    readonly attribute SimpleStateSet all_of_type_simple_state;
    readonly attribute SimpleStateSet all_of_class_simple_state;
    SimpleState create_simple_state (
        in Foundation::DataTypes::Name name,
        in Foundation::DataTypes::VisibilityKind visibility,
        in boolean is_specification)
        raises (Reflective::MofError);
};

```

```

interface SimpleState : SimpleStateClass, State
{
}; // end of interface SimpleState

```

```

interface SubmachineStateClass : CompositeStateClass
{
    readonly attribute SubmachineStateSet all_of_type_submachine_state;
    readonly attribute SubmachineStateSet all_of_class_submachine_state;
    SubmachineState create_submachine_state (
        in Foundation::DataTypes::Name name,
        in Foundation::DataTypes::VisibilityKind visibility,
        in boolean is_specification,

```

5 UML CORBAfacility InterfaceDefinition

```
        in boolean is_concurrent)
        raises (Reflective::MofError);
};

interface SubmachineState : SubmachineStateClass, CompositeState
{
    StateMachine submachine ()
        raises (Reflective::MofError);
    void set_submachine (in StateMachine new_value)
        raises (Reflective::MofError);
}; // end of interface SubmachineState

interface SynchStateClass : StateVertexClass
{
    readonly attribute SynchStateSet all_of_type_synch_state;
    readonly attribute SynchStateSet all_of_class_synch_state;
    SynchState create_synch_state (
        in Foundation::DataTypes::Name name,
        in Foundation::DataTypes::VisibilityKind visibility,
        in boolean is_specification,
        in Foundation::DataTypes::UnlimitedInteger bound)
        raises (Reflective::MofError);
};

interface SynchState : SynchStateClass, StateVertex
{
    Foundation::DataTypes::UnlimitedInteger bound ()
        raises (Reflective::MofError);
    void set_bound (in Foundation::DataTypes::UnlimitedInteger new_value)
        raises (Reflective::MofError);
}; // end of interface SynchState

interface StubStateClass : StateVertexClass
{
    readonly attribute StubStateSet all_of_type_stub_state;
    readonly attribute StubStateSet all_of_class_stub_state;
    StubState create_stub_state (
        in Foundation::DataTypes::Name name,
        in Foundation::DataTypes::VisibilityKind visibility,
        in boolean is_specification,
        in Foundation::DataTypes::Name reference_state)
        raises (Reflective::MofError);
};

interface StubState : StubStateClass, StateVertex
{
    Foundation::DataTypes::Name reference_state ()
        raises (Reflective::MofError);
    void set_reference_state (in Foundation::DataTypes::Name new_value)
        raises (Reflective::MofError);
}; // end of interface StubState
```

```

interface FinalStateClass : StateClass
{
    readonly attribute FinalStateSet all_of_type_final_state;
    readonly attribute FinalStateSet all_of_class_final_state;
    FinalState create_final_state (
        in Foundation::DataTypes::Name name,
        in Foundation::DataTypes::VisibilityKind visibility,
        in boolean is_specification)
        raises (Reflective::MofError);
};

interface FinalState : FinalStateClass, State
{
}; // end of interface FinalState

struct AState1EntryLink
{
    State state1;
    CommonBehavior::Action entry;
};
typedef sequence<AState1EntryLink> AState1EntryLinkSet;

interface AState1Entry : Reflective::RefAssociation
{
    AState1EntryLinkSet all_a_state1_entry_links()
        raises (Reflective::MofError);
    boolean exists (
        in State state1,
        in CommonBehavior::Action entry)
        raises (Reflective::MofError);
    State state1 (in CommonBehavior::Action entry)
        raises (Reflective::MofError);
    CommonBehavior::Action entry (in State state1)
        raises (Reflective::MofError);
    void add (
        in State state1,
        in CommonBehavior::Action entry)
        raises (Reflective::MofError);
    void modify_state1 (
        in State state1,
        in CommonBehavior::Action entry,
        in State new_state1)
        raises (Reflective::NotFound, Reflective::MofError);
    void modify_entry (
        in State state1,
        in CommonBehavior::Action entry,
        in CommonBehavior::Action new_entry)
        raises (Reflective::NotFound, Reflective::MofError);
    void remove (
        in State state1,

```

5 UML CORBAfacility InterfaceDefinition

```
        in CommonBehavior::Action entry)
        raises (Reflective::NotFound, Reflective::MofError);
}; // end of interface AState1Entry

struct AState2ExitLink
{
    State state2;
    CommonBehavior::Action exit;
};
typedef sequence<AState2ExitLink> AState2ExitLinkSet;

interface AState2Exit : Reflective::RefAssociation
{
    AState2ExitLinkSet all_a_state2_exit_links()
        raises (Reflective::MofError);
    boolean exists (
        in State state2,
        in CommonBehavior::Action exit)
        raises (Reflective::MofError);
    State state2 (in CommonBehavior::Action exit)
        raises (Reflective::MofError);
    CommonBehavior::Action exit (in State state2)
        raises (Reflective::MofError);
    void add (
        in State state2,
        in CommonBehavior::Action exit)
        raises (Reflective::MofError);
    void modify_state2 (
        in State state2,
        in CommonBehavior::Action exit,
        in State new_state2)
        raises (Reflective::NotFound, Reflective::MofError);
    void modify_exit (
        in State state2,
        in CommonBehavior::Action exit,
        in CommonBehavior::Action new_exit)
        raises (Reflective::NotFound, Reflective::MofError);
    void remove (
        in State state2,
        in CommonBehavior::Action exit)
        raises (Reflective::NotFound, Reflective::MofError);
}; // end of interface AState2Exit

struct AEventParameterLink
{
    StateMachines::Event event;
    Foundation::Core::Parameter parameter;
};
typedef sequence<AEventParameterLink> AEventParameterLinkSet;

interface AEventParameter : Reflective::RefAssociation
```

```

{
  AEventParameterLinkSet all_a_event_parameter_links()
    raises (Reflective::MofError);
  boolean exists (
    in StateMachines::Event event,
    in Foundation::Core::Parameter parameter)
    raises (Reflective::MofError);
  StateMachines::Event event (in Foundation::Core::Parameter parameter)
    raises (Reflective::MofError);
  ParameterUList parameter (in StateMachines::Event event)
    raises (Reflective::MofError);
  void add (
    in StateMachines::Event event,
    in Foundation::Core::Parameter parameter)
    raises (Reflective::MofError);
  void add_before_parameter (
    in StateMachines::Event event,
    in Foundation::Core::Parameter parameter,
    in Foundation::Core::Parameter before)
    raises (Reflective::NotFound, Reflective::MofError);
  void modify_event (
    in StateMachines::Event event,
    in Foundation::Core::Parameter parameter,
    in StateMachines::Event new_event)
    raises (Reflective::NotFound, Reflective::MofError);
  void modify_parameter (
    in StateMachines::Event event,
    in Foundation::Core::Parameter parameter,
    in Foundation::Core::Parameter new_parameter)
    raises (Reflective::NotFound, Reflective::MofError);
  void remove (
    in StateMachines::Event event,
    in Foundation::Core::Parameter parameter)
    raises (Reflective::NotFound, Reflective::MofError);
}; // end of interface AEventParameter

struct AGuardTransitionLink
{
  StateMachines::Guard guard;
  StateMachines::Transition transition;
};
typedef sequence<AGuardTransitionLink> AGuardTransitionLinkSet;

interface AGuardTransition : Reflective::RefAssociation
{
  AGuardTransitionLinkSet all_a_guard_transition_links()
    raises (Reflective::MofError);
  boolean exists (
    in StateMachines::Guard guard,
    in StateMachines::Transition transition)
    raises (Reflective::MofError);
}

```

5 UML CORBAfacility InterfaceDefinition

```
StateMachines::Guard guard (in StateMachines::Transition transition)
  raises (Reflective::MofError);
StateMachines::Transition transition (in StateMachines::Guard guard)
  raises (Reflective::MofError);
void add (
  in StateMachines::Guard guard,
  in StateMachines::Transition transition)
  raises (Reflective::MofError);
void modify_guard (
  in StateMachines::Guard guard,
  in StateMachines::Transition transition,
  in StateMachines::Guard new_guard)
  raises (Reflective::NotFound, Reflective::MofError);
void modify_transition (
  in StateMachines::Guard guard,
  in StateMachines::Transition transition,
  in StateMachines::Transition new_transition)
  raises (Reflective::NotFound, Reflective::MofError);
void remove (
  in StateMachines::Guard guard,
  in StateMachines::Transition transition)
  raises (Reflective::NotFound, Reflective::MofError);
}; // end of interface AGuardTransition

struct ASignalOccurrenceLink
{
  CommonBehavior::Signal signal;
  SignalEvent occurrence;
};
typedef sequence<ASignalOccurrenceLink> ASignalOccurrenceLinkSet;

interface ASignalOccurrence : Reflective::RefAssociation
{
  ASignalOccurrenceLinkSet all_a_signal_occurrence_links()
    raises (Reflective::MofError);
  boolean exists (
    in CommonBehavior::Signal signal,
    in SignalEvent occurrence)
    raises (Reflective::MofError);
  CommonBehavior::Signal signal (in SignalEvent occurrence)
    raises (Reflective::MofError);
  SignalEventSet occurrence (in CommonBehavior::Signal signal)
    raises (Reflective::MofError);
  void add (
    in CommonBehavior::Signal signal,
    in SignalEvent occurrence)
    raises (Reflective::MofError);
  void modify_signal (
    in CommonBehavior::Signal signal,
    in SignalEvent occurrence,
    in CommonBehavior::Signal new_signal)
```

```

    raises (Reflective::NotFound, Reflective::MofError);
void modify_occurrence (
    in CommonBehavior::Signal signal,
    in SignalEvent occurrence,
    in SignalEvent new_occurrence)
    raises (Reflective::NotFound, Reflective::MofError);
void remove (
    in CommonBehavior::Signal signal,
    in SignalEvent occurrence)
    raises (Reflective::NotFound, Reflective::MofError);
}; // end of interface ASignalOccurrence

struct ABehaviorContextLink
{
    StateMachine behavior;
    Foundation::Core::ModelElement uml_context;
};
typedef sequence<ABehaviorContextLink> ABehaviorContextLinkSet;

interface ABehaviorContext : Reflective::RefAssociation
{
    ABehaviorContextLinkSet all_a_behavior_context_links()
        raises (Reflective::MofError);
    boolean exists (
        in StateMachine behavior,
        in Foundation::Core::ModelElement uml_context)
        raises (Reflective::MofError);
    StateMachineSet behavior (in Foundation::Core::ModelElement uml_context)
        raises (Reflective::MofError);
    Foundation::Core::ModelElement uml_context (in StateMachine behavior)
        raises (Reflective::MofError);
    void add (
        in StateMachine behavior,
        in Foundation::Core::ModelElement uml_context)
        raises (Reflective::MofError);
    void modify_behavior (
        in StateMachine behavior,
        in Foundation::Core::ModelElement uml_context,
        in StateMachine new_behavior)
        raises (Reflective::NotFound, Reflective::MofError);
    void modify_uml_context (
        in StateMachine behavior,
        in Foundation::Core::ModelElement uml_context,
        in Foundation::Core::ModelElement new_uml_context)
        raises (Reflective::NotFound, Reflective::MofError);
    void remove (
        in StateMachine behavior,
        in Foundation::Core::ModelElement uml_context)
        raises (Reflective::NotFound, Reflective::MofError);
}; // end of interface ABehaviorContext

```

5 UML CORBAfacility InterfaceDefinition

```
struct ATopStateMachineLink
{
    State top;
    StateMachine state_machine;
};
typedef sequence<ATopStateMachineLink> ATopStateMachineLinkSet;

interface ATopStateMachine : Reflective::RefAssociation
{
    ATopStateMachineLinkSet all_a_top_state_machine_links()
        raises (Reflective::MofError);
    boolean exists (
        in State top,
        in StateMachine state_machine)
        raises (Reflective::MofError);
    State top (in StateMachine state_machine)
        raises (Reflective::MofError);
    StateMachine state_machine (in State top)
        raises (Reflective::MofError);
    void add (
        in State top,
        in StateMachine state_machine)
        raises (Reflective::MofError);
    void modify_top (
        in State top,
        in StateMachine state_machine,
        in State new_top)
        raises (Reflective::NotFound, Reflective::MofError);
    void modify_state_machine (
        in State top,
        in StateMachine state_machine,
        in StateMachine new_state_machine)
        raises (Reflective::NotFound, Reflective::MofError);
    void remove (
        in State top,
        in StateMachine state_machine)
        raises (Reflective::NotFound, Reflective::MofError);
}; // end of interface ATopStateMachine

struct AStateDeferrableEventLink
{
    StateMachines::State state;
    Event deferrable_event;
};
typedef sequence<AStateDeferrableEventLink> AStateDeferrableEventLinkSet;

interface AStateDeferrableEvent : Reflective::RefAssociation
{
    AStateDeferrableEventLinkSet all_a_state_deferrable_event_links()
        raises (Reflective::MofError);
    boolean exists (
```



```

    in StateMachines::State state,
    in Event deferrable_event)
    raises (Reflective::MofError);
StateSet state (in Event deferrable_event)
    raises (Reflective::MofError);
EventSet deferrable_event (in StateMachines::State state)
    raises (Reflective::MofError);
void add (
    in StateMachines::State state,
    in Event deferrable_event)
    raises (Reflective::MofError);
void modify_state (
    in StateMachines::State state,
    in Event deferrable_event,
    in StateMachines::State new_state)
    raises (Reflective::NotFound, Reflective::MofError);
void modify_deferrable_event (
    in StateMachines::State state,
    in Event deferrable_event,
    in Event new_deferrable_event)
    raises (Reflective::NotFound, Reflective::MofError);
void remove (
    in StateMachines::State state,
    in Event deferrable_event)
    raises (Reflective::NotFound, Reflective::MofError);
}; // end of interface AStateDeferrableEvent

struct AOccurrenceOperationLink
{
    CallEvent occurrence;
    Foundation::Core::Operation operation;
};
typedef sequence<AOccurrenceOperationLink> AOccurrenceOperationLinkSet;

interface AOccurrenceOperation : Reflective::RefAssociation
{
    AOccurrenceOperationLinkSet all_a_occurrence_operation_links()
        raises (Reflective::MofError);
    boolean exists (
        in CallEvent occurrence,
        in Foundation::Core::Operation operation)
        raises (Reflective::MofError);
    CallEventSet occurrence (in Foundation::Core::Operation operation)
        raises (Reflective::MofError);
    Foundation::Core::Operation operation (in CallEvent occurrence)
        raises (Reflective::MofError);
    void add (
        in CallEvent occurrence,
        in Foundation::Core::Operation operation)
        raises (Reflective::MofError);
    void modify_occurrence (

```

5 UML CORBAfacility InterfaceDefinition

```
    in CallEvent occurrence,
    in Foundation::Core::Operation operation,
    in CallEvent new_occurrence)
    raises (Reflective::NotFound, Reflective::MofError);
void modify_operation (
    in CallEvent occurrence,
    in Foundation::Core::Operation operation,
    in Foundation::Core::Operation new_operation)
    raises (Reflective::NotFound, Reflective::MofError);
void remove (
    in CallEvent occurrence,
    in Foundation::Core::Operation operation)
    raises (Reflective::NotFound, Reflective::MofError);
}; // end of interface AOccurrenceOperation

struct AContainerSubvertexLink
{
    CompositeState container;
    StateVertex subvertex;
};
typedef sequence<AContainerSubvertexLink> AContainerSubvertexLinkSet;

interface AContainerSubvertex : Reflective::RefAssociation
{
    AContainerSubvertexLinkSet all_a_container_subvertex_links()
        raises (Reflective::MofError);
    boolean exists (
        in CompositeState container,
        in StateVertex subvertex)
        raises (Reflective::MofError);
    CompositeState container (in StateVertex subvertex)
        raises (Reflective::MofError);
    StateVertexSet subvertex (in CompositeState container)
        raises (Reflective::MofError);
    void add (
        in CompositeState container,
        in StateVertex subvertex)
        raises (Reflective::MofError);
    void modify_container (
        in CompositeState container,
        in StateVertex subvertex,
        in CompositeState new_container)
        raises (Reflective::NotFound, Reflective::MofError);
    void modify_subvertex (
        in CompositeState container,
        in StateVertex subvertex,
        in StateVertex new_subvertex)
        raises (Reflective::NotFound, Reflective::MofError);
    void remove (
        in CompositeState container,
        in StateVertex subvertex)
```

```

    raises (Reflective::NotFound, Reflective::MofError);
}; // end of interface AContainerSubvertex

struct ATransitionEffectLink
{
    StateMachines::Transition transition;
    CommonBehavior::Action effect;
};
typedef sequence<ATransitionEffectLink> ATransitionEffectLinkSet;

interface ATransitionEffect : Reflective::RefAssociation
{
    ATransitionEffectLinkSet all_a_transition_effect_links()
        raises (Reflective::MofError);
    boolean exists (
        in StateMachines::Transition transition,
        in CommonBehavior::Action effect)
        raises (Reflective::MofError);
    StateMachines::Transition transition (in CommonBehavior::Action effect)
        raises (Reflective::MofError);
    CommonBehavior::Action effect (in StateMachines::Transition transition)
        raises (Reflective::MofError);
    void add (
        in StateMachines::Transition transition,
        in CommonBehavior::Action effect)
        raises (Reflective::MofError);
    void modify_transition (
        in StateMachines::Transition transition,
        in CommonBehavior::Action effect,
        in StateMachines::Transition new_transition)
        raises (Reflective::NotFound, Reflective::MofError);
    void modify_effect (
        in StateMachines::Transition transition,
        in CommonBehavior::Action effect,
        in CommonBehavior::Action new_effect)
        raises (Reflective::NotFound, Reflective::MofError);
    void remove (
        in StateMachines::Transition transition,
        in CommonBehavior::Action effect)
        raises (Reflective::NotFound, Reflective::MofError);
}; // end of interface ATransitionEffect

struct AStateInternalTransitionLink
{
    StateMachines::State state;
    Transition internal_transition;
};
typedef sequence<AStateInternalTransitionLink> AStateInternalTransitionLinkSet;

interface AStateInternalTransition : Reflective::RefAssociation
{

```

5 UML CORBAfacility InterfaceDefinition

```
AStateInternalTransitionLinkSet all_a_state_internal_transition_links()
    raises (Reflective::MofError);
boolean exists (
    in StateMachines::State state,
    in Transition internal_transition)
    raises (Reflective::MofError);
StateMachines::State state (in Transition internal_transition)
    raises (Reflective::MofError);
TransitionSet internal_transition (in StateMachines::State state)
    raises (Reflective::MofError);
void add (
    in StateMachines::State state,
    in Transition internal_transition)
    raises (Reflective::MofError);
void modify_state (
    in StateMachines::State state,
    in Transition internal_transition,
    in StateMachines::State new_state)
    raises (Reflective::NotFound, Reflective::MofError);
void modify_internal_transition (
    in StateMachines::State state,
    in Transition internal_transition,
    in Transition new_internal_transition)
    raises (Reflective::NotFound, Reflective::MofError);
void remove (
    in StateMachines::State state,
    in Transition internal_transition)
    raises (Reflective::NotFound, Reflective::MofError);
}; // end of interface AStateInternalTransition

struct ATransitionTriggerLink
{
    StateMachines::Transition transition;
    Event trigger;
};
typedef sequence<ATransitionTriggerLink> ATransitionTriggerLinkSet;

interface ATransitionTrigger : Reflective::RefAssociation
{
    ATransitionTriggerLinkSet all_a_transition_trigger_links()
        raises (Reflective::MofError);
    boolean exists (
        in StateMachines::Transition transition,
        in Event trigger)
        raises (Reflective::MofError);
    TransitionSet transition (in Event trigger)
        raises (Reflective::MofError);
    Event trigger (in StateMachines::Transition transition)
        raises (Reflective::MofError);
    void add (
        in StateMachines::Transition transition,
```

```

    in Event trigger)
    raises (Reflective::MofError);
void modify_transition (
    in StateMachines::Transition transition,
    in Event trigger,
    in StateMachines::Transition new_transition)
    raises (Reflective::NotFound, Reflective::MofError);
void modify_trigger (
    in StateMachines::Transition transition,
    in Event trigger,
    in Event new_trigger)
    raises (Reflective::NotFound, Reflective::MofError);
void remove (
    in StateMachines::Transition transition,
    in Event trigger)
    raises (Reflective::NotFound, Reflective::MofError);
}; // end of interface ATransitionTrigger

struct AStateMachineTransitionsLink
{
    StateMachine state_machine;
    Transition transitions;
};
typedef sequence<AStateMachineTransitionsLink> AStateMachineTransitionsLinkSet;

interface AStateMachineTransitions : Reflective::RefAssociation
{
    AStateMachineTransitionsLinkSet all_a_state_machine_transitions_links()
        raises (Reflective::MofError);
    boolean exists (
        in StateMachine state_machine,
        in Transition transitions)
        raises (Reflective::MofError);
    StateMachine state_machine (in Transition transitions)
        raises (Reflective::MofError);
    TransitionSet transitions (in StateMachine state_machine)
        raises (Reflective::MofError);
    void add (
        in StateMachine state_machine,
        in Transition transitions)
        raises (Reflective::MofError);
    void modify_state_machine (
        in StateMachine state_machine,
        in Transition transitions,
        in StateMachine new_state_machine)
        raises (Reflective::NotFound, Reflective::MofError);
    void modify_transitions (
        in StateMachine state_machine,
        in Transition transitions,
        in Transition new_transitions)
        raises (Reflective::NotFound, Reflective::MofError);
};

```

5 UML CORBAfacility InterfaceDefinition

```
void remove (
    in StateMachine state_machine,
    in Transition transitions)
    raises (Reflective::NotFound, Reflective::MofError);
}; // end of interface AStateMachineTransitions

struct AOutgoingSourceLink
{
    Transition outgoing;
    StateVertex source;
};
typedef sequence<AOutgoingSourceLink> AOutgoingSourceLinkSet;

interface AOutgoingSource : Reflective::RefAssociation
{
    AOutgoingSourceLinkSet all_a_outgoing_source_links()
        raises (Reflective::MofError);
    boolean exists (
        in Transition outgoing,
        in StateVertex source)
        raises (Reflective::MofError);
    TransitionSet outgoing (in StateVertex source)
        raises (Reflective::MofError);
    StateVertex source (in Transition outgoing)
        raises (Reflective::MofError);
    void add (
        in Transition outgoing,
        in StateVertex source)
        raises (Reflective::MofError);
    void modify_outgoing (
        in Transition outgoing,
        in StateVertex source,
        in Transition new_outgoing)
        raises (Reflective::NotFound, Reflective::MofError);
    void modify_source (
        in Transition outgoing,
        in StateVertex source,
        in StateVertex new_source)
        raises (Reflective::NotFound, Reflective::MofError);
    void remove (
        in Transition outgoing,
        in StateVertex source)
        raises (Reflective::NotFound, Reflective::MofError);
}; // end of interface AOutgoingSource

struct AlncomingTargetLink
{
    Transition incoming;
    StateVertex target;
};
typedef sequence<AlncomingTargetLink> AlncomingTargetLinkSet;
```

```

interface AlncomingTarget : Reflective::RefAssociation
{
  AlncomingTargetLinkSet all_a_incoming_target_links()
    raises (Reflective::MofError);
  boolean exists (
    in Transition incoming,
    in StateVertex target)
    raises (Reflective::MofError);
  TransitionSet incoming (in StateVertex target)
    raises (Reflective::MofError);
  StateVertex target (in Transition incoming)
    raises (Reflective::MofError);
  void add (
    in Transition incoming,
    in StateVertex target)
    raises (Reflective::MofError);
  void modify_incoming (
    in Transition incoming,
    in StateVertex target,
    in Transition new_incoming)
    raises (Reflective::NotFound, Reflective::MofError);
  void modify_target (
    in Transition incoming,
    in StateVertex target,
    in StateVertex new_target)
    raises (Reflective::NotFound, Reflective::MofError);
  void remove (
    in Transition incoming,
    in StateVertex target)
    raises (Reflective::NotFound, Reflective::MofError);
}; // end of interface AlncomingTarget

struct ASubMachineStateSubmachineLink
{
  SubmachineState sub_machine_state;
  StateMachine submachine;
};
typedef sequence<ASubMachineStateSubmachineLink>
    ASubMachineStateSubmachineLinkSet;

interface ASubMachineStateSubmachine : Reflective::RefAssociation
{
  ASubMachineStateSubmachineLinkSet all_a_sub_machine_state_submachine_links()
    raises (Reflective::MofError);
  boolean exists (
    in SubmachineState sub_machine_state,
    in StateMachine submachine)
    raises (Reflective::MofError);
  SubmachineStateSet sub_machine_state (in StateMachine submachine)
    raises (Reflective::MofError);
}

```

5 UML CORBAfacility InterfaceDefinition

```
StateMachine submachine (in SubmachineState sub_machine_state)
  raises (Reflective::MofError);
void add (
  in SubmachineState sub_machine_state,
  in StateMachine submachine)
  raises (Reflective::MofError);
void modify_sub_machine_state (
  in SubmachineState sub_machine_state,
  in StateMachine submachine,
  in SubmachineState new_sub_machine_state)
  raises (Reflective::NotFound, Reflective::MofError);
void modify_submachine (
  in SubmachineState sub_machine_state,
  in StateMachine submachine,
  in StateMachine new_submachine)
  raises (Reflective::NotFound, Reflective::MofError);
void remove (
  in SubmachineState sub_machine_state,
  in StateMachine submachine)
  raises (Reflective::NotFound, Reflective::MofError);
}; // end of interface ASubMachineStateSubmachine

struct AState3DoActivityLink
{
  State state3;
  CommonBehavior::Action do_activity;
};
typedef sequence<AState3DoActivityLink> AState3DoActivityLinkSet;

interface AState3DoActivity : Reflective::RefAssociation
{
  AState3DoActivityLinkSet all_a_state3_do_activity_links()
    raises (Reflective::MofError);
  boolean exists (
    in State state3,
    in CommonBehavior::Action do_activity)
    raises (Reflective::MofError);
  State state3 (in CommonBehavior::Action do_activity)
    raises (Reflective::MofError);
  CommonBehavior::Action do_activity (in State state3)
    raises (Reflective::MofError);
  void add (
    in State state3,
    in CommonBehavior::Action do_activity)
    raises (Reflective::MofError);
  void modify_state3 (
    in State state3,
    in CommonBehavior::Action do_activity,
    in State new_state3)
    raises (Reflective::NotFound, Reflective::MofError);
  void modify_do_activity (
```



```

    in State state3,
    in CommonBehavior::Action do_activity,
    in CommonBehavior::Action new_do_activity)
    raises (Reflective::NotFound, Reflective::MofError);
void remove (
    in State state3,
    in CommonBehavior::Action do_activity)
    raises (Reflective::NotFound, Reflective::MofError);
}; // end of interface AState3DoActivity

interface StateMachinesPackage : Reflective::RefPackage
{
    readonly attribute StateMachineClass state_machine_ref;
    readonly attribute EventClass event_ref;
    readonly attribute StateClass state_ref;
    readonly attribute TimeEventClass time_event_ref;
    readonly attribute CallEventClass call_event_ref;
    readonly attribute SignalEventClass signal_event_ref;
    readonly attribute TransitionClass transition_ref;
    readonly attribute StateVertexClass state_vertex_ref;
    readonly attribute CompositeStateClass composite_state_ref;
    readonly attribute ChangeEventClass change_event_ref;
    readonly attribute GuardClass guard_ref;
    readonly attribute PseudostateClass pseudostate_ref;
    readonly attribute SimpleStateClass simple_state_ref;
    readonly attribute SubmachineStateClass submachine_state_ref;
    readonly attribute SynchStateClass synch_state_ref;
    readonly attribute StubStateClass stub_state_ref;
    readonly attribute FinalStateClass final_state_ref;
    readonly attribute AState1Entry a_state1_entry_ref;
    readonly attribute AState2Exit a_state2_exit_ref;
    readonly attribute AEventParameter a_event_parameter_ref;
    readonly attribute AGuardTransition a_guard_transition_ref;
    readonly attribute ASignalOccurrence a_signal_occurrence_ref;
    readonly attribute ABehaviorContext a_behavior_context_ref;
    readonly attribute ATopStateMachine a_top_state_machine_ref;
    readonly attribute AStateDeferrableEvent a_state_deferrable_event_ref;
    readonly attribute AOccurrenceOperation a_occurrence_operation_ref;
    readonly attribute AContainerSubvertex a_container_subvertex_ref;
    readonly attribute ATransitionEffect a_transition_effect_ref;
    readonly attribute AStateInternalTransition a_state_internal_transition_ref;
    readonly attribute ATransitionTrigger a_transition_trigger_ref;
    readonly attribute AStateMachineTransitions a_state_machine_transitions_ref;
    readonly attribute AOutgoingSource a_outgoing_source_ref;
    readonly attribute AIncomingTarget a_incoming_target_ref;
    readonly attribute ASubMachineStateSubmachine
        a_sub_machine_state_submachine_ref;
    readonly attribute AState3DoActivity a_state3_do_activity_ref;
};
}; // end of module StateMachines

```

5 UML CORBAfacility InterfaceDefinition

```
module Collaborations
{
  interface CollaborationClass;
  interface Collaboration;
  typedef sequence<Collaboration> CollaborationSet;
  interface ClassifierRoleClass;
  interface ClassifierRole;
  typedef sequence<ClassifierRole> ClassifierRoleSet;
  interface AssociationRoleClass;
  interface AssociationRole;
  typedef sequence<AssociationRole> AssociationRoleSet;
  interface AssociationEndRoleClass;
  interface AssociationEndRole;
  typedef sequence<AssociationEndRole> AssociationEndRoleSet;
  interface MessageClass;
  interface Message;
  typedef sequence<Message> MessageSet;
  interface InteractionClass;
  interface Interaction;
  typedef sequence<Interaction> InteractionSet;
  interface CollaborationsPackage;

  interface CollaborationClass : Foundation::Core::NamespaceClass,
                                Foundation::Core::GeneralizableElementClass
  {
    readonly attribute CollaborationSet all_of_type_collaboration;
    readonly attribute CollaborationSet all_of_class_collaboration;
    Collaboration create_collaboration (
      in Foundation::DataTypes::Name name,
      in Foundation::DataTypes::VisibilityKind visibility,
      in boolean is_specification,
      in boolean is_root,
      in boolean is_leaf,
      in boolean is_abstract)
      raises (Reflective::MofError);
  };

  interface Collaboration : CollaborationClass, Foundation::Core::Namespace,
                            Foundation::Core::GeneralizableElement
  {
    InteractionSet interaction ()
      raises (Reflective::MofError);
    void set_interaction (in InteractionSet new_value)
      raises (Reflective::MofError);
    void add_interaction (in Collaborations::Interaction new_element)
      raises (Reflective::MofError);
    void modify_interaction (
      in Collaborations::Interaction old_element,
      in Collaborations::Interaction new_element)
      raises (Reflective::NotFound, Reflective::MofError);
    void remove_interaction (in Collaborations::Interaction old_element)
```

```

    raises (Reflective::NotFound, Reflective::MofError);
Foundation::Core::Classifier represented_classifier ()
    raises (Reflective::NotSet, Reflective::MofError);
void set_represented_classifier (in Foundation::Core::Classifier new_value)
    raises (Reflective::MofError);
void unset_represented_classifier ()
    raises (Reflective::MofError);
Foundation::Core::Operation represented_operation ()
    raises (Reflective::NotSet, Reflective::MofError);
void set_represented_operation (in Foundation::Core::Operation new_value)
    raises (Reflective::MofError);
void unset_represented_operation ()
    raises (Reflective::MofError);
ModelElementSet constraining_element ()
    raises (Reflective::MofError);
void set_constraining_element (in ModelElementSet new_value)
    raises (Reflective::MofError);
void add_constraining_element (in Foundation::Core::ModelElement new_element)
    raises (Reflective::MofError);
void modify_constraining_element (
    in Foundation::Core::ModelElement old_element,
    in Foundation::Core::ModelElement new_element)
    raises (Reflective::NotFound, Reflective::MofError);
void remove_constraining_element (in Foundation::Core::ModelElement old_element)
    raises (Reflective::NotFound, Reflective::MofError);
}; // end of interface Collaboration

interface ClassifierRoleClass : Foundation::Core::ClassifierClass
{
    readonly attribute ClassifierRoleSet all_of_type_classifier_role;
    readonly attribute ClassifierRoleSet all_of_class_classifier_role;
    ClassifierRole create_classifier_role (
        in Foundation::DataTypes::Name name,
        in Foundation::DataTypes::VisibilityKind visibility,
        in boolean is_specification,
        in boolean is_root,
        in boolean is_leaf,
        in boolean is_abstract,
        in Foundation::DataTypes::Multiplicity multiplicity)
        raises (Reflective::MofError);
};

interface ClassifierRole : ClassifierRoleClass, Foundation::Core::Classifier
{
    Foundation::DataTypes::Multiplicity multiplicity ()
        raises (Reflective::MofError);
    void set_multiplicity (in Foundation::DataTypes::Multiplicity new_value)
        raises (Reflective::MofError);
    ClassifierSet base ()
        raises (Reflective::MofError);
    void set_base (in ClassifierSet new_value)

```

5 UML CORBAfacility InterfaceDefinition

```
    raises (Reflective::MofError);
void add_base (in Foundation::Core::Classifier new_element)
    raises (Reflective::MofError);
void modify_base (
    in Foundation::Core::Classifier old_element,
    in Foundation::Core::Classifier new_element)
    raises (Reflective::NotFound, Reflective::MofError);
void remove_base (in Foundation::Core::Classifier old_element)
    raises (Reflective::NotFound, Reflective::MofError);
FeatureSet available_feature ()
    raises (Reflective::MofError);
void set_available_feature (in FeatureSet new_value)
    raises (Reflective::MofError);
void add_available_feature (in Foundation::Core::Feature new_element)
    raises (Reflective::MofError);
void modify_available_feature (
    in Foundation::Core::Feature old_element,
    in Foundation::Core::Feature new_element)
    raises (Reflective::NotFound, Reflective::MofError);
void remove_available_feature (in Foundation::Core::Feature old_element)
    raises (Reflective::NotFound, Reflective::MofError);
MessageSet message2 ()
    raises (Reflective::MofError);
void set_message2 (in MessageSet new_value)
    raises (Reflective::MofError);
void add_message2 (in Message new_element)
    raises (Reflective::MofError);
void modify_message2 (
    in Message old_element,
    in Message new_element)
    raises (Reflective::NotFound, Reflective::MofError);
void remove_message2 (in Message old_element)
    raises (Reflective::NotFound, Reflective::MofError);
MessageSet message1 ()
    raises (Reflective::MofError);
void set_message1 (in MessageSet new_value)
    raises (Reflective::MofError);
void add_message1 (in Message new_element)
    raises (Reflective::MofError);
void modify_message1 (
    in Message old_element,
    in Message new_element)
    raises (Reflective::NotFound, Reflective::MofError);
void remove_message1 (in Message old_element)
    raises (Reflective::NotFound, Reflective::MofError);
ModelElementSet available_contents ()
    raises (Reflective::MofError);
void set_available_contents (in ModelElementSet new_value)
    raises (Reflective::MofError);
void add_available_contents (in Foundation::Core::ModelElement new_element)
    raises (Reflective::MofError);
```

```

void modify_available_contents (
    in Foundation::Core::ModelElement old_element,
    in Foundation::Core::ModelElement new_element)
    raises (Reflective::NotFound, Reflective::MofError);
void remove_available_contents (in Foundation::Core::ModelElement old_element)
    raises (Reflective::NotFound, Reflective::MofError);
}; // end of interface ClassifierRole

```

```

interface AssociationRoleClass : Foundation::Core::AssociationClass
{
    readonly attribute AssociationRoleSet all_of_type_association_role;
    readonly attribute AssociationRoleSet all_of_class_association_role;
    AssociationRole create_association_role (
        in Foundation::DataTypes::Name name,
        in Foundation::DataTypes::VisibilityKind visibility,
        in boolean is_specification,
        in boolean is_root,
        in boolean is_leaf,
        in boolean is_abstract,
        in Foundation::DataTypes::Multiplicity multiplicity)
        raises (Reflective::MofError);
};

```

```

interface AssociationRole : AssociationRoleClass, Foundation::Core::Association
{
    Foundation::DataTypes::Multiplicity multiplicity ()
        raises (Reflective::MofError);
    void set_multiplicity (in Foundation::DataTypes::Multiplicity new_value)
        raises (Reflective::MofError);
    Foundation::Core::Association base ()
        raises (Reflective::NotSet, Reflective::MofError);
    void set_base (in Foundation::Core::Association new_value)
        raises (Reflective::MofError);
    void unset_base ()
        raises (Reflective::MofError);
    MessageSet message ()
        raises (Reflective::MofError);
    void set_message (in MessageSet new_value)
        raises (Reflective::MofError);
    void add_message (in Collaborations::Message new_element)
        raises (Reflective::MofError);
    void modify_message (
        in Collaborations::Message old_element,
        in Collaborations::Message new_element)
        raises (Reflective::NotFound, Reflective::MofError);
    void remove_message (in Collaborations::Message old_element)
        raises (Reflective::NotFound, Reflective::MofError);
}; // end of interface AssociationRole

```

```

interface AssociationEndRoleClass : Foundation::Core::AssociationEndClass
{

```

5 UML CORBAfacility InterfaceDefinition

```
readonly attribute AssociationEndRoleSet all_of_type_association_end_role;
readonly attribute AssociationEndRoleSet all_of_class_association_end_role;
AssociationEndRole create_association_end_role (
    in Foundation::DataTypes::Name name,
    in Foundation::DataTypes::VisibilityKind visibility,
    in boolean is_specification,
    in boolean is_navigable,
    in Foundation::DataTypes::OrderingKind ordering,
    in Foundation::DataTypes::AggregationKind aggregation,
    in Foundation::DataTypes::ScopeKind target_scope,
    in Foundation::DataTypes::Multiplicity multiplicity,
    in Foundation::DataTypes::ChangeableKind changeability,
    in Foundation::DataTypes::Multiplicity collaboration_multiplicity)
    raises (Reflective::MofError);
};

interface AssociationEndRole : AssociationEndRoleClass,
                             Foundation::Core::AssociationEnd
{
    Foundation::DataTypes::Multiplicity collaboration_multiplicity ()
        raises (Reflective::MofError);
    void set_collaboration_multiplicity (in Foundation::DataTypes::Multiplicity new_value)
        raises (Reflective::MofError);
    Foundation::Core::AssociationEnd base ()
        raises (Reflective::NotSet, Reflective::MofError);
    void set_base (in Foundation::Core::AssociationEnd new_value)
        raises (Reflective::MofError);
    void unset_base ()
        raises (Reflective::MofError);
    UmlAttributeSet available_qualifier ()
        raises (Reflective::MofError);
    void set_available_qualifier (in UmlAttributeSet new_value)
        raises (Reflective::MofError);
    void add_available_qualifier (in Foundation::Core::UmlAttribute new_element)
        raises (Reflective::MofError);
    void modify_available_qualifier (
        in Foundation::Core::UmlAttribute old_element,
        in Foundation::Core::UmlAttribute new_element)
        raises (Reflective::NotFound, Reflective::MofError);
    void remove_available_qualifier (in Foundation::Core::UmlAttribute old_element)
        raises (Reflective::NotFound, Reflective::MofError);
}; // end of interface AssociationEndRole

interface MessageClass : Foundation::Core::ModelElementClass
{
    readonly attribute MessageSet all_of_type_message;
    readonly attribute MessageSet all_of_class_message;
    Message create_message (
        in Foundation::DataTypes::Name name,
        in Foundation::DataTypes::VisibilityKind visibility,
        in boolean is_specification)
```

```

    raises (Reflective::MofError);
};

interface Message : MessageClass, Foundation::Core::ModelElement
{
    Collaborations::Interaction interaction ()
        raises (Reflective::MofError);
    void set_interaction (in Collaborations::Interaction new_value)
        raises (Reflective::MofError);
    Message activator ()
        raises (Reflective::NotSet, Reflective::MofError);
    void set_activator (in Message new_value)
        raises (Reflective::MofError);
    void unset_activator ()
        raises (Reflective::MofError);
    MessageSet message4 ()
        raises (Reflective::MofError);
    void set_message4 (in MessageSet new_value)
        raises (Reflective::MofError);
    void add_message4 (in Message new_element)
        raises (Reflective::MofError);
    void modify_message4 (
        in Message old_element,
        in Message new_element)
        raises (Reflective::NotFound, Reflective::MofError);
    void remove_message4 (in Message old_element)
        raises (Reflective::NotFound, Reflective::MofError);
    ClassifierRole sender ()
        raises (Reflective::MofError);
    void set_sender (in ClassifierRole new_value)
        raises (Reflective::MofError);
    ClassifierRole receiver ()
        raises (Reflective::MofError);
    void set_receiver (in ClassifierRole new_value)
        raises (Reflective::MofError);
    MessageSet message3 ()
        raises (Reflective::MofError);
    void set_message3 (in MessageSet new_value)
        raises (Reflective::MofError);
    void add_message3 (in Message new_element)
        raises (Reflective::MofError);
    void modify_message3 (
        in Message old_element,
        in Message new_element)
        raises (Reflective::NotFound, Reflective::MofError);
    void remove_message3 (in Message old_element)
        raises (Reflective::NotFound, Reflective::MofError);
    MessageSet predecessor ()
        raises (Reflective::MofError);
    void set_predecessor (in MessageSet new_value)
        raises (Reflective::MofError);
}

```

5 UML CORBAfacility InterfaceDefinition

```
void add_predecessor (in Message new_element)
    raises (Reflective::MofError);
void modify_predecessor (
    in Message old_element,
    in Message new_element)
    raises (Reflective::NotFound, Reflective::MofError);
void remove_predecessor (in Message old_element)
    raises (Reflective::NotFound, Reflective::MofError);
AssociationRole communication_connection ()
    raises (Reflective::NotSet, Reflective::MofError);
void set_communication_connection (in AssociationRole new_value)
    raises (Reflective::MofError);
void unset_communication_connection ()
    raises (Reflective::MofError);
CommonBehavior::Action action ()
    raises (Reflective::MofError);
void set_action (in CommonBehavior::Action new_value)
    raises (Reflective::MofError);
}; // end of interface Message

interface InteractionClass : Foundation::Core::ModelElementClass
{
    readonly attribute InteractionSet all_of_type_interaction;
    readonly attribute InteractionSet all_of_class_interaction;
    Interaction create_interaction (
        in Foundation::DataTypes::Name name,
        in Foundation::DataTypes::VisibilityKind visibility,
        in boolean is_specification)
        raises (Reflective::MofError);
};

interface Interaction : InteractionClass, Foundation::Core::ModelElement
{
    MessageSet message ()
        raises (Reflective::MofError);
    void set_message (in MessageSet new_value)
        raises (Reflective::MofError);
    void add_message (in Collaborations::Message new_element)
        raises (Reflective::MofError);
    void modify_message (
        in Collaborations::Message old_element,
        in Collaborations::Message new_element)
        raises (Reflective::NotFound, Reflective::MofError);
    void remove_message (in Collaborations::Message old_element)
        raises (Reflective::NotFound, Reflective::MofError);
    Collaboration uml_context ()
        raises (Reflective::MofError);
    void set_uml_context (in Collaboration new_value)
        raises (Reflective::MofError);
}; // end of interface Interaction
```



```

struct AInteractionMessageLink
{
    Collaborations::Interaction interaction;
    Collaborations::Message message;
};
typedef sequence<AInteractionMessageLink> AInteractionMessageLinkSet;

interface AInteractionMessage : Reflective::RefAssociation
{
    AInteractionMessageLinkSet all_a_interaction_message_links()
        raises (Reflective::MofError);
    boolean exists (
        in Collaborations::Interaction interaction,
        in Collaborations::Message message)
        raises (Reflective::MofError);
    Collaborations::Interaction interaction (in Collaborations::Message message)
        raises (Reflective::MofError);
    MessageSet message (in Collaborations::Interaction interaction)
        raises (Reflective::MofError);
    void add (
        in Collaborations::Interaction interaction,
        in Collaborations::Message message)
        raises (Reflective::MofError);
    void modify_interaction (
        in Collaborations::Interaction interaction,
        in Collaborations::Message message,
        in Collaborations::Interaction new_interaction)
        raises (Reflective::NotFound, Reflective::MofError);
    void modify_message (
        in Collaborations::Interaction interaction,
        in Collaborations::Message message,
        in Collaborations::Message new_message)
        raises (Reflective::NotFound, Reflective::MofError);
    void remove (
        in Collaborations::Interaction interaction,
        in Collaborations::Message message)
        raises (Reflective::NotFound, Reflective::MofError);
}; // end of interface AInteractionMessage

struct AContextInteractionLink
{
    Collaboration uml_context;
    Collaborations::Interaction interaction;
};
typedef sequence<AContextInteractionLink> AContextInteractionLinkSet;

interface AContextInteraction : Reflective::RefAssociation
{
    AContextInteractionLinkSet all_a_context_interaction_links()
        raises (Reflective::MofError);
    boolean exists (

```

5 UML CORBAfacility InterfaceDefinition

```
    in Collaboration uml_context,
    in Collaborations::Interaction interaction)
    raises (Reflective::MofError);
Collaboration uml_context (in Collaborations::Interaction interaction)
    raises (Reflective::MofError);
InteractionSet interaction (in Collaboration uml_context)
    raises (Reflective::MofError);
void add (
    in Collaboration uml_context,
    in Collaborations::Interaction interaction)
    raises (Reflective::MofError);
void modify_uml_context (
    in Collaboration uml_context,
    in Collaborations::Interaction interaction,
    in Collaboration new_uml_context)
    raises (Reflective::NotFound, Reflective::MofError);
void modify_interaction (
    in Collaboration uml_context,
    in Collaborations::Interaction interaction,
    in Collaborations::Interaction new_interaction)
    raises (Reflective::NotFound, Reflective::MofError);
void remove (
    in Collaboration uml_context,
    in Collaborations::Interaction interaction)
    raises (Reflective::NotFound, Reflective::MofError);
}; // end of interface AContextInteraction

struct AClassifierRoleBaseLink
{
    ClassifierRole classifier_role;
    Foundation::Core::Classifier base;
};
typedef sequence<AClassifierRoleBaseLink> AClassifierRoleBaseLinkSet;

interface AClassifierRoleBase : Reflective::RefAssociation
{
    AClassifierRoleBaseLinkSet all_a_classifier_role_base_links()
        raises (Reflective::MofError);
    boolean exists (
        in ClassifierRole classifier_role,
        in Foundation::Core::Classifier base)
        raises (Reflective::MofError);
    ClassifierRoleSet classifier_role (in Foundation::Core::Classifier base)
        raises (Reflective::MofError);
    ClassifierSet base (in ClassifierRole classifier_role)
        raises (Reflective::MofError);
    void add (
        in ClassifierRole classifier_role,
        in Foundation::Core::Classifier base)
        raises (Reflective::MofError);
    void modify_classifier_role (
```

```

    in ClassifierRole classifier_role,
    in Foundation::Core::Classifier base,
    in ClassifierRole new_classifier_role)
    raises (Reflective::NotFound, Reflective::MofError);
void modify_base (
    in ClassifierRole classifier_role,
    in Foundation::Core::Classifier base,
    in Foundation::Core::Classifier new_base)
    raises (Reflective::NotFound, Reflective::MofError);
void remove (
    in ClassifierRole classifier_role,
    in Foundation::Core::Classifier base)
    raises (Reflective::NotFound, Reflective::MofError);
}; // end of interface AClassifierRoleBase

struct ABaseAssociationEndRoleLink
{
    Foundation::Core::AssociationEnd base;
    AssociationEndRole association_end_role;
};
typedef sequence<ABaseAssociationEndRoleLink> ABaseAssociationEndRoleLinkSet;

interface ABaseAssociationEndRole : Reflective::RefAssociation
{
    ABaseAssociationEndRoleLinkSet all_a_base_association_end_role_links()
        raises (Reflective::MofError);
    boolean exists (
        in Foundation::Core::AssociationEnd base,
        in AssociationEndRole association_end_role)
        raises (Reflective::MofError);
    Foundation::Core::AssociationEnd base (in AssociationEndRole association_end_role)
        raises (Reflective::MofError);
    AssociationEndRoleSet association_end_role (in Foundation::Core::AssociationEnd
                                                base)
        raises (Reflective::MofError);
    void add (
        in Foundation::Core::AssociationEnd base,
        in AssociationEndRole association_end_role)
        raises (Reflective::MofError);
    void modify_base (
        in Foundation::Core::AssociationEnd base,
        in AssociationEndRole association_end_role,
        in Foundation::Core::AssociationEnd new_base)
        raises (Reflective::NotFound, Reflective::MofError);
    void modify_association_end_role (
        in Foundation::Core::AssociationEnd base,
        in AssociationEndRole association_end_role,
        in AssociationEndRole new_association_end_role)
        raises (Reflective::NotFound, Reflective::MofError);
    void remove (
        in Foundation::Core::AssociationEnd base,

```

5 UML CORBAfacility InterfaceDefinition

```
        in AssociationEndRole association_end_role)
        raises (Reflective::NotFound, Reflective::MofError);
}; // end of interface ABaseAssociationEndRole

struct ABaseAssociationRoleLink
{
    Foundation::Core::Association base;
    AssociationRole association_role;
};
typedef sequence<ABaseAssociationRoleLink> ABaseAssociationRoleLinkSet;

interface ABaseAssociationRole : Reflective::RefAssociation
{
    ABaseAssociationRoleLinkSet all_a_base_association_role_links()
        raises (Reflective::MofError);
    boolean exists (
        in Foundation::Core::Association base,
        in AssociationRole association_role)
        raises (Reflective::MofError);
    Foundation::Core::Association base (in AssociationRole association_role)
        raises (Reflective::MofError);
    AssociationRoleSet association_role (in Foundation::Core::Association base)
        raises (Reflective::MofError);
    void add (
        in Foundation::Core::Association base,
        in AssociationRole association_role)
        raises (Reflective::MofError);
    void modify_base (
        in Foundation::Core::Association base,
        in AssociationRole association_role,
        in Foundation::Core::Association new_base)
        raises (Reflective::NotFound, Reflective::MofError);
    void modify_association_role (
        in Foundation::Core::Association base,
        in AssociationRole association_role,
        in AssociationRole new_association_role)
        raises (Reflective::NotFound, Reflective::MofError);
    void remove (
        in Foundation::Core::Association base,
        in AssociationRole association_role)
        raises (Reflective::NotFound, Reflective::MofError);
}; // end of interface ABaseAssociationRole

struct AClassifierRoleAvailableFeatureLink
{
    ClassifierRole classifier_role;
    Foundation::Core::Feature available_feature;
};
typedef sequence<AClassifierRoleAvailableFeatureLink>
    AClassifierRoleAvailableFeatureLinkSet;
```

```

interface AClassifierRoleAvailableFeature : Reflective::RefAssociation
{
  AClassifierRoleAvailableFeatureLinkSet all_a_classifier_role_available_feature_links()
    raises (Reflective::MofError);
  boolean exists (
    in ClassifierRole classifier_role,
    in Foundation::Core::Feature available_feature)
    raises (Reflective::MofError);
  ClassifierRoleSet classifier_role (in Foundation::Core::Feature available_feature)
    raises (Reflective::MofError);
  FeatureSet available_feature (in ClassifierRole classifier_role)
    raises (Reflective::MofError);
  void add (
    in ClassifierRole classifier_role,
    in Foundation::Core::Feature available_feature)
    raises (Reflective::MofError);
  void modify_classifier_role (
    in ClassifierRole classifier_role,
    in Foundation::Core::Feature available_feature,
    in ClassifierRole new_classifier_role)
    raises (Reflective::NotFound, Reflective::MofError);
  void modify_available_feature (
    in ClassifierRole classifier_role,
    in Foundation::Core::Feature available_feature,
    in Foundation::Core::Feature new_available_feature)
    raises (Reflective::NotFound, Reflective::MofError);
  void remove (
    in ClassifierRole classifier_role,
    in Foundation::Core::Feature available_feature)
    raises (Reflective::NotFound, Reflective::MofError);
}; // end of interface AClassifierRoleAvailableFeature

struct AMessage4ActivatorLink
{
  Message message4;
  Message activator;
};
typedef sequence<AMessage4ActivatorLink> AMessage4ActivatorLinkSet;

interface AMessage4Activator : Reflective::RefAssociation
{
  AMessage4ActivatorLinkSet all_a_message4_activator_links()
    raises (Reflective::MofError);
  boolean exists (
    in Message message4,
    in Message activator)
    raises (Reflective::MofError);
  MessageSet message4 (in Message activator)
    raises (Reflective::MofError);
  Message activator (in Message message4)
    raises (Reflective::MofError);
};

```

5 UML CORBAfacility InterfaceDefinition

```
void add (
    in Message message4,
    in Message activator)
    raises (Reflective::MofError);
void modify_message4 (
    in Message message4,
    in Message activator,
    in Message new_message4)
    raises (Reflective::NotFound, Reflective::MofError);
void modify_activator (
    in Message message4,
    in Message activator,
    in Message new_activator)
    raises (Reflective::NotFound, Reflective::MofError);
void remove (
    in Message message4,
    in Message activator)
    raises (Reflective::NotFound, Reflective::MofError);
}; // end of interface AMessage4Activator

struct ACollaborationRepresentedClassifierLink
{
    Collaborations::Collaboration collaboration;
    Foundation::Core::Classifier represented_classifier;
};
typedef sequence<ACollaborationRepresentedClassifierLink>
    ACollaborationRepresentedClassifierLinkSet;

interface ACollaborationRepresentedClassifier : Reflective::RefAssociation
{
    ACollaborationRepresentedClassifierLinkSet
        all_a_collaboration_represented_classifier_links()
        raises (Reflective::MofError);
    boolean exists (
        in Collaborations::Collaboration collaboration,
        in Foundation::Core::Classifier represented_classifier)
        raises (Reflective::MofError);
    CollaborationSet collaboration (in Foundation::Core::Classifier represented_classifier)
        raises (Reflective::MofError);
    Foundation::Core::Classifier represented_classifier (in Collaborations::Collaboration
        collaboration)
        raises (Reflective::MofError);
    void add (
        in Collaborations::Collaboration collaboration,
        in Foundation::Core::Classifier represented_classifier)
        raises (Reflective::MofError);
    void modify_collaboration (
        in Collaborations::Collaboration collaboration,
        in Foundation::Core::Classifier represented_classifier,
        in Collaborations::Collaboration new_collaboration)
        raises (Reflective::NotFound, Reflective::MofError);
```

```

void modify_represented_classifier (
    in Collaborations::Collaboration collaboration,
    in Foundation::Core::Classifier represented_classifier,
    in Foundation::Core::Classifier new_represented_classifier)
    raises (Reflective::NotFound, Reflective::MofError);
void remove (
    in Collaborations::Collaboration collaboration,
    in Foundation::Core::Classifier represented_classifier)
    raises (Reflective::NotFound, Reflective::MofError);
}; // end of interface ACollaborationRepresentedClassifier

struct AMessage2SenderLink
{
    Message message2;
    ClassifierRole sender;
};
typedef sequence<AMessage2SenderLink> AMessage2SenderLinkSet;

interface AMessage2Sender : Reflective::RefAssociation
{
    AMessage2SenderLinkSet all_a_message2_sender_links()
        raises (Reflective::MofError);
    boolean exists (
        in Message message2,
        in ClassifierRole sender)
        raises (Reflective::MofError);
    MessageSet message2 (in ClassifierRole sender)
        raises (Reflective::MofError);
    ClassifierRole sender (in Message message2)
        raises (Reflective::MofError);
    void add (
        in Message message2,
        in ClassifierRole sender)
        raises (Reflective::MofError);
    void modify_message2 (
        in Message message2,
        in ClassifierRole sender,
        in Message new_message2)
        raises (Reflective::NotFound, Reflective::MofError);
    void modify_sender (
        in Message message2,
        in ClassifierRole sender,
        in ClassifierRole new_sender)
        raises (Reflective::NotFound, Reflective::MofError);
    void remove (
        in Message message2,
        in ClassifierRole sender)
        raises (Reflective::NotFound, Reflective::MofError);
}; // end of interface AMessage2Sender

struct AReceiverMessage1Link

```

5 UML CORBAfacility InterfaceDefinition

```
{
  ClassifierRole receiver;
  Message message1;
};
typedef sequence<AReceiverMessage1Link> AReceiverMessage1LinkSet;

interface AReceiverMessage1 : Reflective::RefAssociation
{
  AReceiverMessage1LinkSet all_a_receiver_message1_links()
    raises (Reflective::MofError);
  boolean exists (
    in ClassifierRole receiver,
    in Message message1)
    raises (Reflective::MofError);
  ClassifierRole receiver (in Message message1)
    raises (Reflective::MofError);
  MessageSet message1 (in ClassifierRole receiver)
    raises (Reflective::MofError);
  void add (
    in ClassifierRole receiver,
    in Message message1)
    raises (Reflective::MofError);
  void modify_receiver (
    in ClassifierRole receiver,
    in Message message1,
    in ClassifierRole new_receiver)
    raises (Reflective::NotFound, Reflective::MofError);
  void modify_message1 (
    in ClassifierRole receiver,
    in Message message1,
    in Message new_message1)
    raises (Reflective::NotFound, Reflective::MofError);
  void remove (
    in ClassifierRole receiver,
    in Message message1)
    raises (Reflective::NotFound, Reflective::MofError);
}; // end of interface AReceiverMessage1

struct APredecessorMessage3Link
{
  Message predecessor;
  Message message3;
};
typedef sequence<APredecessorMessage3Link> APredecessorMessage3LinkSet;

interface APredecessorMessage3 : Reflective::RefAssociation
{
  APredecessorMessage3LinkSet all_a_predecessor_message3_links()
    raises (Reflective::MofError);
  boolean exists (
    in Message predecessor,
```



```

    in Message message3)
    raises (Reflective::MofError);
MessageSet predecessor (in Message message3)
    raises (Reflective::MofError);
MessageSet message3 (in Message predecessor)
    raises (Reflective::MofError);
void add (
    in Message predecessor,
    in Message message3)
    raises (Reflective::MofError);
void modify_predecessor (
    in Message predecessor,
    in Message message3,
    in Message new_predecessor)
    raises (Reflective::NotFound, Reflective::MofError);
void modify_message3 (
    in Message predecessor,
    in Message message3,
    in Message new_message3)
    raises (Reflective::NotFound, Reflective::MofError);
void remove (
    in Message predecessor,
    in Message message3)
    raises (Reflective::NotFound, Reflective::MofError);
}; // end of interface APredecessorMessage3

struct AMessageCommunicationConnectionLink
{
    Collaborations::Message message;
    AssociationRole communication_connection;
};
typedef sequence<AMessageCommunicationConnectionLink>
    AMessageCommunicationConnectionLinkSet;

interface AMessageCommunicationConnection : Reflective::RefAssociation
{
    AMessageCommunicationConnectionLinkSet
        all_a_message_communication_connection_links()
        raises (Reflective::MofError);
    boolean exists (
        in Collaborations::Message message,
        in AssociationRole communication_connection)
        raises (Reflective::MofError);
    MessageSet message (in AssociationRole communication_connection)
        raises (Reflective::MofError);
    AssociationRole communication_connection (in Collaborations::Message message)
        raises (Reflective::MofError);
    void add (
        in Collaborations::Message message,
        in AssociationRole communication_connection)
        raises (Reflective::MofError);
};

```

5 UML CORBAfacility InterfaceDefinition

```
void modify_message (
    in Collaborations::Message message,
    in AssociationRole communication_connection,
    in Collaborations::Message new_message)
    raises (Reflective::NotFound, Reflective::MofError);
void modify_communication_connection (
    in Collaborations::Message message,
    in AssociationRole communication_connection,
    in AssociationRole new_communication_connection)
    raises (Reflective::NotFound, Reflective::MofError);
void remove (
    in Collaborations::Message message,
    in AssociationRole communication_connection)
    raises (Reflective::NotFound, Reflective::MofError);
}; // end of interface AMessageCommunicationConnection

struct AClassifierRoleAvailableContentsLink
{
    ClassifierRole classifier_role;
    Foundation::Core::ModelElement available_contents;
};
typedef sequence<AClassifierRoleAvailableContentsLink>
    AClassifierRoleAvailableContentsLinkSet;

interface AClassifierRoleAvailableContents : Reflective::RefAssociation
{
    AClassifierRoleAvailableContentsLinkSet all_a_classifier_role_available_contents_links()
        raises (Reflective::MofError);
    boolean exists (
        in ClassifierRole classifier_role,
        in Foundation::Core::ModelElement available_contents)
        raises (Reflective::MofError);
    ClassifierRoleSet classifier_role (in Foundation::Core::ModelElement available_contents)
        raises (Reflective::MofError);
    ModelElementSet available_contents (in ClassifierRole classifier_role)
        raises (Reflective::MofError);
    void add (
        in ClassifierRole classifier_role,
        in Foundation::Core::ModelElement available_contents)
        raises (Reflective::MofError);
    void modify_classifier_role (
        in ClassifierRole classifier_role,
        in Foundation::Core::ModelElement available_contents,
        in ClassifierRole new_classifier_role)
        raises (Reflective::NotFound, Reflective::MofError);
    void modify_available_contents (
        in ClassifierRole classifier_role,
        in Foundation::Core::ModelElement available_contents,
        in Foundation::Core::ModelElement new_available_contents)
        raises (Reflective::NotFound, Reflective::MofError);
    void remove (
```

```

    in ClassifierRole classifier_role,
    in Foundation::Core::ModelElement available_contents)
    raises (Reflective::NotFound, Reflective::MofError);
}; // end of interface AClassifierRoleAvailableContents

struct AActionMessageLink
{
    CommonBehavior::Action action;
    Collaborations::Message message;
};
typedef sequence<AActionMessageLink> AActionMessageLinkSet;

interface AActionMessage : Reflective::RefAssociation
{
    AActionMessageLinkSet all_a_action_message_links()
    raises (Reflective::MofError);
    boolean exists (
        in CommonBehavior::Action action,
        in Collaborations::Message message)
    raises (Reflective::MofError);
    CommonBehavior::Action action (in Collaborations::Message message)
    raises (Reflective::MofError);
    MessageSet message (in CommonBehavior::Action action)
    raises (Reflective::MofError);
    void add (
        in CommonBehavior::Action action,
        in Collaborations::Message message)
    raises (Reflective::MofError);
    void modify_action (
        in CommonBehavior::Action action,
        in Collaborations::Message message,
        in CommonBehavior::Action new_action)
    raises (Reflective::NotFound, Reflective::MofError);
    void modify_message (
        in CommonBehavior::Action action,
        in Collaborations::Message message,
        in Collaborations::Message new_message)
    raises (Reflective::NotFound, Reflective::MofError);
    void remove (
        in CommonBehavior::Action action,
        in Collaborations::Message message)
    raises (Reflective::NotFound, Reflective::MofError);
}; // end of interface AActionMessage

struct AAssociationEndRoleAvailableQualifierLink
{
    AssociationEndRole association_end_role;
    Foundation::Core::UmlAttribute available_qualifier;
};
typedef sequence<AAssociationEndRoleAvailableQualifierLink>
    AAssociationEndRoleAvailableQualifierLinkSet;

```

5 UML CORBAfacility InterfaceDefinition

```
interface AAssociationEndRoleAvailableQualifier : Reflective::RefAssociation
{
    AAssociationEndRoleAvailableQualifierLinkSet
        all_a_association_end_role_available_qualifier_links()
        raises (Reflective::MofError);
    boolean exists (
        in AssociationEndRole association_end_role,
        in Foundation::Core::UmlAttribute available_qualifier)
        raises (Reflective::MofError);
    AssociationEndRoleSet association_end_role (in Foundation::Core::UmlAttribute
        available_qualifier)
        raises (Reflective::MofError);
    UmlAttributeSet available_qualifier (in AssociationEndRole association_end_role)
        raises (Reflective::MofError);
    void add (
        in AssociationEndRole association_end_role,
        in Foundation::Core::UmlAttribute available_qualifier)
        raises (Reflective::MofError);
    void modify_association_end_role (
        in AssociationEndRole association_end_role,
        in Foundation::Core::UmlAttribute available_qualifier,
        in AssociationEndRole new_association_end_role)
        raises (Reflective::NotFound, Reflective::MofError);
    void modify_available_qualifier (
        in AssociationEndRole association_end_role,
        in Foundation::Core::UmlAttribute available_qualifier,
        in Foundation::Core::UmlAttribute new_available_qualifier)
        raises (Reflective::NotFound, Reflective::MofError);
    void remove (
        in AssociationEndRole association_end_role,
        in Foundation::Core::UmlAttribute available_qualifier)
        raises (Reflective::NotFound, Reflective::MofError);
}; // end of interface AAssociationEndRoleAvailableQualifier

struct ARepresentedOperationCollaborationLink
{
    Foundation::Core::Operation represented_operation;
    Collaborations::Collaboration collaboration;
};
typedef sequence<ARepresentedOperationCollaborationLink>
    ARepresentedOperationCollaborationLinkSet;

interface ARepresentedOperationCollaboration : Reflective::RefAssociation
{
    ARepresentedOperationCollaborationLinkSet
        all_a_represented_operation_collaboration_links()
        raises (Reflective::MofError);
    boolean exists (
        in Foundation::Core::Operation represented_operation,
        in Collaborations::Collaboration collaboration)
```

```

    raises (Reflective::MofError);
Foundation::Core::Operation represented_operation (in Collaborations::Collaboration
    collaboration)
    raises (Reflective::MofError);
CollaborationSet collaboration (in Foundation::Core::Operation represented_operation)
    raises (Reflective::MofError);
void add (
    in Foundation::Core::Operation represented_operation,
    in Collaborations::Collaboration collaboration)
    raises (Reflective::MofError);
void modify_represented_operation (
    in Foundation::Core::Operation represented_operation,
    in Collaborations::Collaboration collaboration,
    in Foundation::Core::Operation new_represented_operation)
    raises (Reflective::NotFound, Reflective::MofError);
void modify_collaboration (
    in Foundation::Core::Operation represented_operation,
    in Collaborations::Collaboration collaboration,
    in Collaborations::Collaboration new_collaboration)
    raises (Reflective::NotFound, Reflective::MofError);
void remove (
    in Foundation::Core::Operation represented_operation,
    in Collaborations::Collaboration collaboration)
    raises (Reflective::NotFound, Reflective::MofError);
}; // end of interface ARepresentedOperationCollaboration

struct ACollaborationConstrainingElementLink
{
    Collaborations::Collaboration collaboration;
    Foundation::Core::ModelElement constraining_element;
};
typedef sequence<ACollaborationConstrainingElementLink>
    ACollaborationConstrainingElementLinkSet;

interface ACollaborationConstrainingElement : Reflective::RefAssociation
{
    ACollaborationConstrainingElementLinkSet
        all_a_collaboration_constraining_element_links()
        raises (Reflective::MofError);
    boolean exists (
        in Collaborations::Collaboration collaboration,
        in Foundation::Core::ModelElement constraining_element)
        raises (Reflective::MofError);
    CollaborationSet collaboration (in Foundation::Core::ModelElement
        constraining_element)
        raises (Reflective::MofError);
    ModelElementSet constraining_element (in Collaborations::Collaboration collaboration)
        raises (Reflective::MofError);
    void add (
        in Collaborations::Collaboration collaboration,
        in Foundation::Core::ModelElement constraining_element)

```

5 UML CORBAfacility InterfaceDefinition

```
    raises (Reflective::MofError);
void modify_collaboration (
    in Collaborations::Collaboration collaboration,
    in Foundation::Core::ModelElement constraining_element,
    in Collaborations::Collaboration new_collaboration)
    raises (Reflective::NotFound, Reflective::MofError);
void modify_constraining_element (
    in Collaborations::Collaboration collaboration,
    in Foundation::Core::ModelElement constraining_element,
    in Foundation::Core::ModelElement new_constraining_element)
    raises (Reflective::NotFound, Reflective::MofError);
void remove (
    in Collaborations::Collaboration collaboration,
    in Foundation::Core::ModelElement constraining_element)
    raises (Reflective::NotFound, Reflective::MofError);
}; // end of interface ACollaborationConstrainingElement

interface CollaborationsPackage : Reflective::RefPackage
{
    readonly attribute CollaborationClass collaboration_ref;
    readonly attribute ClassifierRoleClass classifier_role_ref;
    readonly attribute AssociationRoleClass association_role_ref;
    readonly attribute AssociationEndRoleClass association_end_role_ref;
    readonly attribute MessageClass message_ref;
    readonly attribute InteractionClass interaction_ref;
    readonly attribute AInteractionMessage a_interaction_message_ref;
    readonly attribute AContextInteraction a_context_interaction_ref;
    readonly attribute AClassifierRoleBase a_classifier_role_base_ref;
    readonly attribute ABaseAssociationEndRole a_base_association_end_role_ref;
    readonly attribute ABaseAssociationRole a_base_association_role_ref;
    readonly attribute AClassifierRoleAvailableFeature
        a_classifier_role_available_feature_ref;
    readonly attribute AMessage4Activator a_message4_activator_ref;
    readonly attribute ACollaborationRepresentedClassifier
        a_collaboration_represented_classifier_ref;
    readonly attribute AMessage2Sender a_message2_sender_ref;
    readonly attribute AReceiverMessage1 a_receiver_message1_ref;
    readonly attribute APredecessorMessage3 a_predecessor_message3_ref;
    readonly attribute AMessageCommunicationConnection
        a_message_communication_connection_ref;
    readonly attribute AClassifierRoleAvailableContents
        a_classifier_role_available_contents_ref;
    readonly attribute AActionMessage a_action_message_ref;
    readonly attribute AAssociationEndRoleAvailableQualifier
        a_association_end_role_available_qualifier_ref;
    readonly attribute ARepresentedOperationCollaboration
        a_represented_operation_collaboration_ref;
    readonly attribute ACollaborationConstrainingElement
        a_collaboration_constraining_element_ref;
};
}; // end of module Collaborations
```

```

module ActivityGraphs
{
  interface ActivityGraphClass;
  interface ActivityGraph;
  typedef sequence<ActivityGraph> ActivityGraphSet;
  interface PartitionClass;
  interface Partition;
  typedef sequence<Partition> PartitionSet;
  interface SubactivityStateClass;
  interface SubactivityState;
  typedef sequence<SubactivityState> SubactivityStateSet;
  interface CallStateClass;
  interface CallState;
  typedef sequence<CallState> CallStateSet;
  interface ObjectFlowStateClass;
  interface ObjectFlowState;
  typedef sequence<ObjectFlowState> ObjectFlowStateSet;
  interface ClassifierInStateClass;
  interface ClassifierInState;
  typedef sequence<ClassifierInState> ClassifierInStateSet;
  interface ActionStateClass;
  interface ActionState;
  typedef sequence<ActionState> ActionStateSet;
  interface ActivityGraphsPackage;

  interface ActivityGraphClass : StateMachines::StateMachineClass
  {
    readonly attribute ActivityGraphSet all_of_type_activity_graph;
    readonly attribute ActivityGraphSet all_of_class_activity_graph;
    ActivityGraph create_activity_graph (
      in Foundation::DataTypes::Name name,
      in Foundation::DataTypes::VisibilityKind visibility,
      in boolean is_specification)
      raises (Reflective::MofError);
  };

  interface ActivityGraph : ActivityGraphClass, StateMachines::StateMachine
  {
    PartitionSet partition ()
      raises (Reflective::MofError);
    void set_partition (in PartitionSet new_value)
      raises (Reflective::MofError);
    void unset_partition ()
      raises (Reflective::MofError);
    void add_partition (in ActivityGraphs::Partition new_element)
      raises (Reflective::MofError);
    void modify_partition (
      in ActivityGraphs::Partition old_element,
      in ActivityGraphs::Partition new_element)
      raises (Reflective::NotFound, Reflective::MofError);
  };
}

```

5 UML CORBAfacility InterfaceDefinition

```
void remove_partition (in ActivityGraphs::Partition old_element)
    raises (Reflective::NotFound, Reflective::MofError);
}; // end of interface ActivityGraph

interface PartitionClass : Foundation::Core::ModelElementClass
{
    readonly attribute PartitionSet all_of_type_partition;
    readonly attribute PartitionSet all_of_class_partition;
    Partition create_partition (
        in Foundation::DataTypes::Name name,
        in Foundation::DataTypes::VisibilityKind visibility,
        in boolean is_specification)
        raises (Reflective::MofError);
};

interface Partition : PartitionClass, Foundation::Core::ModelElement
{
    ModelElementSet contents ()
        raises (Reflective::MofError);
    void set_contents (in ModelElementSet new_value)
        raises (Reflective::MofError);
    void add_contents (in Foundation::Core::ModelElement new_element)
        raises (Reflective::MofError);
    void modify_contents (
        in Foundation::Core::ModelElement old_element,
        in Foundation::Core::ModelElement new_element)
        raises (Reflective::NotFound, Reflective::MofError);
    void remove_contents (in Foundation::Core::ModelElement old_element)
        raises (Reflective::NotFound, Reflective::MofError);
    ActivityGraph activity_graph ()
        raises (Reflective::MofError);
    void set_activity_graph (in ActivityGraph new_value)
        raises (Reflective::MofError);
}; // end of interface Partition

interface SubactivityStateClass : StateMachines::SubmachineStateClass
{
    readonly attribute SubactivityStateSet all_of_type_subactivity_state;
    readonly attribute SubactivityStateSet all_of_class_subactivity_state;
    SubactivityState create_subactivity_state (
        in Foundation::DataTypes::Name name,
        in Foundation::DataTypes::VisibilityKind visibility,
        in boolean is_specification,
        in boolean is_concurrent,
        in boolean is_dynamic,
        in Foundation::DataTypes::ArgListsExpression dynamic_arguments,
        in Foundation::DataTypes::Multiplicity dynamic_multiplicity)
        raises (Reflective::MofError);
};

interface SubactivityState : SubactivityStateClass, StateMachines::SubmachineState
```



```

{
  boolean is_dynamic ()
    raises (Reflective::MofError);
  void set_is_dynamic (in boolean new_value)
    raises (Reflective::MofError);
  Foundation::DataTypes::ArgListsExpression dynamic_arguments ()
    raises (Reflective::MofError);
  void set_dynamic_arguments (in Foundation::DataTypes::ArgListsExpression new_value)
    raises (Reflective::MofError);
  Foundation::DataTypes::Multiplicity dynamic_multiplicity ()
    raises (Reflective::MofError);
  void set_dynamic_multiplicity (in Foundation::DataTypes::Multiplicity new_value)
    raises (Reflective::MofError);
}; // end of interface SubactivityState

interface ActionStateClass : StateMachines::SimpleStateClass
{
  readonly attribute ActionStateSet all_of_type_action_state;
  readonly attribute ActionStateSet all_of_class_action_state;
  ActionState create_action_state (
    in Foundation::DataTypes::Name name,
    in Foundation::DataTypes::VisibilityKind visibility,
    in boolean is_specification,
    in boolean is_dynamic,
    in Foundation::DataTypes::ArgListsExpression dynamic_arguments,
    in Foundation::DataTypes::Multiplicity dynamic_multiplicity)
    raises (Reflective::MofError);
};

interface ActionState : ActionStateClass, StateMachines::SimpleState
{
  boolean is_dynamic ()
    raises (Reflective::MofError);
  void set_is_dynamic (in boolean new_value)
    raises (Reflective::MofError);
  Foundation::DataTypes::ArgListsExpression dynamic_arguments ()
    raises (Reflective::MofError);
  void set_dynamic_arguments (in Foundation::DataTypes::ArgListsExpression new_value)
    raises (Reflective::MofError);
  Foundation::DataTypes::Multiplicity dynamic_multiplicity ()
    raises (Reflective::MofError);
  void set_dynamic_multiplicity (in Foundation::DataTypes::Multiplicity new_value)
    raises (Reflective::MofError);
}; // end of interface ActionState

interface CallStateClass : ActionStateClass
{
  readonly attribute CallStateSet all_of_type_call_state;
  readonly attribute CallStateSet all_of_class_call_state;
  CallState create_call_state (
    in Foundation::DataTypes::Name name,

```

5 UML CORBAfacility InterfaceDefinition

```
    in Foundation::DataTypes::VisibilityKind visibility,
    in boolean is_specification,
    in boolean is_dynamic,
    in Foundation::DataTypes::ArgListsExpression dynamic_arguments,
    in Foundation::DataTypes::Multiplicity dynamic_multiplicity)
    raises (Reflective::MofError);
};

interface CallState : CallStateClass, ActionState
{
}; // end of interface CallState

interface ObjectFlowStateClass : StateMachines::SimpleStateClass
{
    readonly attribute ObjectFlowStateSet all_of_type_object_flow_state;
    readonly attribute ObjectFlowStateSet all_of_class_object_flow_state;
    ObjectFlowState create_object_flow_state (
        in Foundation::DataTypes::Name name,
        in Foundation::DataTypes::VisibilityKind visibility,
        in boolean is_specification,
        in boolean is_synch)
        raises (Reflective::MofError);
};

interface ObjectFlowState : ObjectFlowStateClass, StateMachines::SimpleState
{
    boolean is_synch ()
        raises (Reflective::MofError);
    void set_is_synch (in boolean new_value)
        raises (Reflective::MofError);
    ParameterSet parameter ()
        raises (Reflective::MofError);
    void set_parameter (in ParameterSet new_value)
        raises (Reflective::MofError);
    void add_parameter (in Foundation::Core::Parameter new_element)
        raises (Reflective::MofError);
    void modify_parameter (
        in Foundation::Core::Parameter old_element,
        in Foundation::Core::Parameter new_element)
        raises (Reflective::NotFound, Reflective::MofError);
    void remove_parameter (in Foundation::Core::Parameter old_element)
        raises (Reflective::NotFound, Reflective::MofError);
    Foundation::Core::Classifier type ()
        raises (Reflective::MofError);
    void set_type (in Foundation::Core::Classifier new_value)
        raises (Reflective::MofError);
}; // end of interface ObjectFlowState

interface ClassifierInStateClass : Foundation::Core::ClassifierClass
{
    readonly attribute ClassifierInStateSet all_of_type_classifier_in_state;
```

```

readonly attribute ClassifierInStateSet all_of_class_classifier_in_state;
ClassifierInState create_classifier_in_state (
    in Foundation::DataTypes::Name name,
    in Foundation::DataTypes::VisibilityKind visibility,
    in boolean is_specification,
    in boolean is_root,
    in boolean is_leaf,
    in boolean is_abstract)
    raises (Reflective::MofError);
};

interface ClassifierInState : ClassifierInStateClass, Foundation::Core::Classifier
{
    Foundation::Core::Classifier type ()
        raises (Reflective::MofError);
    void set_type (in Foundation::Core::Classifier new_value)
        raises (Reflective::MofError);
    StateMachines::StateSet in_state ()
        raises (Reflective::MofError);
    void set_in_state (in StateMachines::StateSet new_value)
        raises (Reflective::MofError);
    void add_in_state (in StateMachines::State new_element)
        raises (Reflective::MofError);
    void modify_in_state (
        in StateMachines::State old_element,
        in StateMachines::State new_element)
        raises (Reflective::NotFound, Reflective::MofError);
    void remove_in_state (in StateMachines::State old_element)
        raises (Reflective::NotFound, Reflective::MofError);
}; // end of interface ClassifierInState

struct AParameterStateLink
{
    Foundation::Core::Parameter parameter;
    ObjectFlowState state;
};
typedef sequence<AParameterStateLink> AParameterStateLinkSet;

interface AParameterState : Reflective::RefAssociation
{
    AParameterStateLinkSet all_a_parameter_state_links()
        raises (Reflective::MofError);
    boolean exists (
        in Foundation::Core::Parameter parameter,
        in ObjectFlowState state)
        raises (Reflective::MofError);
    ParameterSet parameter (in ObjectFlowState state)
        raises (Reflective::MofError);
    ObjectFlowStateSet state (in Foundation::Core::Parameter parameter)
        raises (Reflective::MofError);
    void add (

```

5 UML CORBAfacility InterfaceDefinition

```
    in Foundation::Core::Parameter parameter,
    in ObjectFlowState state)
    raises (Reflective::MofError);
void modify_parameter (
    in Foundation::Core::Parameter parameter,
    in ObjectFlowState state,
    in Foundation::Core::Parameter new_parameter)
    raises (Reflective::NotFound, Reflective::MofError);
void modify_state (
    in Foundation::Core::Parameter parameter,
    in ObjectFlowState state,
    in ObjectFlowState new_state)
    raises (Reflective::NotFound, Reflective::MofError);
void remove (
    in Foundation::Core::Parameter parameter,
    in ObjectFlowState state)
    raises (Reflective::NotFound, Reflective::MofError);
}; // end of interface AParameterState

struct ATypeClassifierInStateLink
{
    Foundation::Core::Classifier type;
    ClassifierInState classifier_in_state;
};
typedef sequence<ATypeClassifierInStateLink> ATypeClassifierInStateLinkSet;

interface ATypeClassifierInState : Reflective::RefAssociation
{
    ATypeClassifierInStateLinkSet all_a_type_classifier_in_state_links()
        raises (Reflective::MofError);
    boolean exists (
        in Foundation::Core::Classifier type,
        in ClassifierInState classifier_in_state)
        raises (Reflective::MofError);
    Foundation::Core::Classifier type (in ClassifierInState classifier_in_state)
        raises (Reflective::MofError);
    ClassifierInStateSet classifier_in_state (in Foundation::Core::Classifier type)
        raises (Reflective::MofError);
    void add (
        in Foundation::Core::Classifier type,
        in ClassifierInState classifier_in_state)
        raises (Reflective::MofError);
    void modify_type (
        in Foundation::Core::Classifier type,
        in ClassifierInState classifier_in_state,
        in Foundation::Core::Classifier new_type)
        raises (Reflective::NotFound, Reflective::MofError);
    void modify_classifier_in_state (
        in Foundation::Core::Classifier type,
        in ClassifierInState classifier_in_state,
        in ClassifierInState new_classifier_in_state)
```

```

        raises (Reflective::NotFound, Reflective::MofError);
    void remove (
        in Foundation::Core::Classifier type,
        in ClassifierInState classifier_in_state)
        raises (Reflective::NotFound, Reflective::MofError);
}; // end of interface ATypeClassifierInState

struct AContentsPartitionLink
{
    Foundation::Core::ModelElement contents;
    ActivityGraphs::Partition partition;
};
typedef sequence<AContentsPartitionLink> AContentsPartitionLinkSet;

interface AContentsPartition : Reflective::RefAssociation
{
    AContentsPartitionLinkSet all_a_contents_partition_links()
        raises (Reflective::MofError);
    boolean exists (
        in Foundation::Core::ModelElement contents,
        in ActivityGraphs::Partition partition)
        raises (Reflective::MofError);
    ModelElementSet contents (in ActivityGraphs::Partition partition)
        raises (Reflective::MofError);
    PartitionSet partition (in Foundation::Core::ModelElement contents)
        raises (Reflective::MofError);
    void add (
        in Foundation::Core::ModelElement contents,
        in ActivityGraphs::Partition partition)
        raises (Reflective::MofError);
    void modify_contents (
        in Foundation::Core::ModelElement contents,
        in ActivityGraphs::Partition partition,
        in Foundation::Core::ModelElement new_contents)
        raises (Reflective::NotFound, Reflective::MofError);
    void modify_partition (
        in Foundation::Core::ModelElement contents,
        in ActivityGraphs::Partition partition,
        in ActivityGraphs::Partition new_partition)
        raises (Reflective::NotFound, Reflective::MofError);
    void remove (
        in Foundation::Core::ModelElement contents,
        in ActivityGraphs::Partition partition)
        raises (Reflective::NotFound, Reflective::MofError);
}; // end of interface AContentsPartition

struct AActivityGraphPartitionLink
{
    ActivityGraph activity_graph;
    ActivityGraphs::Partition partition;
};

```

5 UML CORBAfacility InterfaceDefinition

```
typedef sequence<AAActivityGraphPartitionLink> AAActivityGraphPartitionLinkSet;

interface AAActivityGraphPartition : Reflective::RefAssociation
{
    AAActivityGraphPartitionLinkSet all_a_activity_graph_partition_links()
        raises (Reflective::MofError);
    boolean exists (
        in ActivityGraph activity_graph,
        in ActivityGraphs::Partition partition)
        raises (Reflective::MofError);
    ActivityGraph activity_graph (in ActivityGraphs::Partition partition)
        raises (Reflective::MofError);
    PartitionSet partition (in ActivityGraph activity_graph)
        raises (Reflective::MofError);
    void add (
        in ActivityGraph activity_graph,
        in ActivityGraphs::Partition partition)
        raises (Reflective::MofError);
    void modify_activity_graph (
        in ActivityGraph activity_graph,
        in ActivityGraphs::Partition partition,
        in ActivityGraph new_activity_graph)
        raises (Reflective::NotFound, Reflective::MofError);
    void modify_partition (
        in ActivityGraph activity_graph,
        in ActivityGraphs::Partition partition,
        in ActivityGraphs::Partition new_partition)
        raises (Reflective::NotFound, Reflective::MofError);
    void remove (
        in ActivityGraph activity_graph,
        in ActivityGraphs::Partition partition)
        raises (Reflective::NotFound, Reflective::MofError);
}; // end of interface AAActivityGraphPartition

struct ATypeObjectFlowStateLink
{
    Foundation::Core::Classifier type;
    ObjectFlowState object_flow_state;
};
typedef sequence<ATypeObjectFlowStateLink> ATypeObjectFlowStateLinkSet;

interface ATypeObjectFlowState : Reflective::RefAssociation
{
    ATypeObjectFlowStateLinkSet all_a_type_object_flow_state_links()
        raises (Reflective::MofError);
    boolean exists (
        in Foundation::Core::Classifier type,
        in ObjectFlowState object_flow_state)
        raises (Reflective::MofError);
    Foundation::Core::Classifier type (in ObjectFlowState object_flow_state)
        raises (Reflective::MofError);
};
```

```

ObjectFlowStateSet object_flow_state (in Foundation::Core::Classifier type)
  raises (Reflective::MofError);
void add (
  in Foundation::Core::Classifier type,
  in ObjectFlowState object_flow_state)
  raises (Reflective::MofError);
void modify_type (
  in Foundation::Core::Classifier type,
  in ObjectFlowState object_flow_state,
  in Foundation::Core::Classifier new_type)
  raises (Reflective::NotFound, Reflective::MofError);
void modify_object_flow_state (
  in Foundation::Core::Classifier type,
  in ObjectFlowState object_flow_state,
  in ObjectFlowState new_object_flow_state)
  raises (Reflective::NotFound, Reflective::MofError);
void remove (
  in Foundation::Core::Classifier type,
  in ObjectFlowState object_flow_state)
  raises (Reflective::NotFound, Reflective::MofError);
}; // end of interface ATypeObjectFlowState

struct AClassifierInStateInStateLink
{
  ClassifierInState classifier_in_state;
  StateMachines::State in_state;
};
typedef sequence<AClassifierInStateInStateLink> AClassifierInStateInStateLinkSet;

interface AClassifierInStateInState : Reflective::RefAssociation
{
  AClassifierInStateInStateLinkSet all_a_classifier_in_state_in_state_links()
    raises (Reflective::MofError);
  boolean exists (
    in ClassifierInState classifier_in_state,
    in StateMachines::State in_state)
    raises (Reflective::MofError);
  ClassifierInStateSet classifier_in_state (in StateMachines::State in_state)
    raises (Reflective::MofError);
  StateMachines::StateSet in_state (in ClassifierInState classifier_in_state)
    raises (Reflective::MofError);
  void add (
    in ClassifierInState classifier_in_state,
    in StateMachines::State in_state)
    raises (Reflective::MofError);
  void modify_classifier_in_state (
    in ClassifierInState classifier_in_state,
    in StateMachines::State in_state,
    in ClassifierInState new_classifier_in_state)
    raises (Reflective::NotFound, Reflective::MofError);
  void modify_in_state (

```

5 UML CORBAfacility InterfaceDefinition

```
        in ClassifierInState classifier_in_state,
        in StateMachines::State in_state,
        in StateMachines::State new_in_state)
        raises (Reflective::NotFound, Reflective::MofError);
void remove (
    in ClassifierInState classifier_in_state,
    in StateMachines::State in_state)
    raises (Reflective::NotFound, Reflective::MofError);
}; // end of interface AClassifierInStateInState

interface ActivityGraphsPackage : Reflective::RefPackage
{
    readonly attribute ActivityGraphClass activity_graph_ref;
    readonly attribute PartitionClass partition_ref;
    readonly attribute SubactivityStateClass subactivity_state_ref;
    readonly attribute CallStateClass call_state_ref;
    readonly attribute ObjectFlowStateClass object_flow_state_ref;
    readonly attribute ClassifierInStateClass classifier_in_state_ref;
    readonly attribute ActionStateClass action_state_ref;
    readonly attribute AParameterState a_parameter_state_ref;
    readonly attribute ATypeClassifierInState a_type_classifier_in_state_ref;
    readonly attribute AContentsPartition a_contents_partition_ref;
    readonly attribute AActivityGraphPartition a_activity_graph_partition_ref;
    readonly attribute ATypeObjectFlowState a_type_object_flow_state_ref;
    readonly attribute AClassifierInStateInState a_classifier_in_state_in_state_ref;
};
}; // end of module ActivityGraphs

interface BehavioralElementsPackageFactory
{
    BehavioralElementsPackage create_behavioral_elements_package ()
        raises (Reflective::MofError);
};

interface BehavioralElementsPackage : Reflective::RefPackage
{
    readonly attribute CommonBehavior::CommonBehaviorPackage common_behavior_ref;
    readonly attribute UseCases::UseCasesPackage use_cases_ref;
    readonly attribute StateMachines::StateMachinesPackage state_machines_ref;
    readonly attribute Collaborations::CollaborationsPackage collaborations_ref;
    readonly attribute ActivityGraphs::ActivityGraphsPackage activity_graphs_ref;
};
};
```

5.4.4 ModelManagement

```

#pragma prefix "org.omg.Uml"
#include "Reflective.idl"
#include "Foundation.idl"

module ModelManagement
{
  interface ModelClass;
  interface Model;
  typedef sequence<Model> ModelSet;
  interface PackageClass;
  interface Package;
  typedef sequence<Package> PackageSet;
  interface SubsystemClass;
  interface Subsystem;
  typedef sequence<Subsystem> SubsystemSet;
  interface ElementImportClass;
  interface ElementImport;
  typedef sequence<ElementImport> ElementImportSet;
  interface ModelManagementPackage;

  interface PackageClass : Foundation::Core::NamespaceClass,
                          Foundation::Core::GeneralizableElementClass
  {
    readonly attribute PackageSet all_of_type_package;
    readonly attribute PackageSet all_of_class_package;
    Package create_package (
      in Foundation::DataTypes::Name name,
      in Foundation::DataTypes::VisibilityKind visibility,
      in boolean is_specification,
      in boolean is_root,
      in boolean is_leaf,
      in boolean is_abstract)
      raises (Reflective::MofError);
  };

  interface Package : PackageClass, Foundation::Core::Namespace,
                    Foundation::Core::GeneralizableElement
  {
    ElementImportSet element_import ()
      raises (Reflective::MofError);
    void set_element_import (in ElementImportSet new_value)
      raises (Reflective::MofError);
    void add_element_import (in ElementImport new_element)
      raises (Reflective::MofError);
    void modify_element_import (
      in ElementImport old_element,
      in ElementImport new_element)
      raises (Reflective::NotFound, Reflective::MofError);
  };
}

```

5 UML CORBAfacility InterfaceDefinition

```
void remove_element_import (in ElementImport old_element)
  raises (Reflective::NotFound, Reflective::MofError);
}; // end of interface Package

interface ModelClass : PackageClass
{
  readonly attribute ModelSet all_of_type_model;
  readonly attribute ModelSet all_of_class_model;
  Model create_model (
    in Foundation::DataTypes::Name name,
    in Foundation::DataTypes::VisibilityKind visibility,
    in boolean is_specification,
    in boolean is_root,
    in boolean is_leaf,
    in boolean is_abstract)
    raises (Reflective::MofError);
};

interface Model : ModelClass, Package
{
}; // end of interface Model

interface SubsystemClass : Foundation::Core::ClassifierClass, PackageClass
{
  readonly attribute SubsystemSet all_of_type_subsystem;
  readonly attribute SubsystemSet all_of_class_subsystem;
  Subsystem create_subsystem (
    in Foundation::DataTypes::Name name,
    in Foundation::DataTypes::VisibilityKind visibility,
    in boolean is_specification,
    in boolean is_root,
    in boolean is_leaf,
    in boolean is_abstract,
    in boolean is_instantiable)
    raises (Reflective::MofError);
};

interface Subsystem : SubsystemClass, Foundation::Core::Classifier, Package
{
  boolean is_instantiable ()
    raises (Reflective::MofError);
  void set_is_instantiable (in boolean new_value)
    raises (Reflective::MofError);
}; // end of interface Subsystem

interface ElementImportClass : Reflective::RefObject
{
  readonly attribute ElementImportSet all_of_type_element_import;
  readonly attribute ElementImportSet all_of_class_element_import;
  ElementImport create_element_import (
    in Foundation::DataTypes::VisibilityKind visibility,
```

```

    in Foundation::DataTypes::Name alias)
    raises (Reflective::MofError);
};

interface ElementImport : ElementImportClass
{
    Foundation::DataTypes::VisibilityKind visibility ()
        raises (Reflective::MofError);
    void set_visibility (in Foundation::DataTypes::VisibilityKind new_value)
        raises (Reflective::MofError);
    Foundation::DataTypes::Name alias ()
        raises (Reflective::MofError);
    void set_alias (in Foundation::DataTypes::Name new_value)
        raises (Reflective::MofError);
    Foundation::Core::ModelElement model_element ()
        raises (Reflective::MofError);
    void set_model_element (in Foundation::Core::ModelElement new_value)
        raises (Reflective::MofError);
    ModelManagement::Package package ()
        raises (Reflective::MofError);
    void set_package (in ModelManagement::Package new_value)
        raises (Reflective::MofError);
}; // end of interface ElementImport

struct AModelElementElementImportLink
{
    Foundation::Core::ModelElement model_element;
    ElementImport element_import;
};
typedef sequence<AModelElementElementImportLink>
    AModelElementElementImportLinkSet;

interface AModelElementElementImport : Reflective::RefAssociation
{
    AModelElementElementImportLinkSet all_a_model_element_element_import_links()
        raises (Reflective::MofError);
    boolean exists (
        in Foundation::Core::ModelElement model_element,
        in ElementImport element_import)
        raises (Reflective::MofError);
    Foundation::Core::ModelElement model_element (in ElementImport element_import)
        raises (Reflective::MofError);
    ElementImportSet element_import (in Foundation::Core::ModelElement model_element)
        raises (Reflective::MofError);
    void add (
        in Foundation::Core::ModelElement model_element,
        in ElementImport element_import)
        raises (Reflective::MofError);
    void modify_model_element (
        in Foundation::Core::ModelElement model_element,
        in ElementImport element_import,

```

5 UML CORBAfacility InterfaceDefinition

```
    in Foundation::Core::ModelElement new_model_element)
    raises (Reflective::NotFound, Reflective::MofError);
void modify_element_import (
    in Foundation::Core::ModelElement model_element,
    in ElementImport element_import,
    in ElementImport new_element_import)
    raises (Reflective::NotFound, Reflective::MofError);
void remove (
    in Foundation::Core::ModelElement model_element,
    in ElementImport element_import)
    raises (Reflective::NotFound, Reflective::MofError);
}; // end of interface AModelElementElementImport

struct APackageElementImportLink
{
    ModelManagement::Package package;
    ElementImport element_import;
};
typedef sequence<APackageElementImportLink> APackageElementImportLinkSet;

interface APackageElementImport : Reflective::RefAssociation
{
    APackageElementImportLinkSet all_a_package_element_import_links()
        raises (Reflective::MofError);
    boolean exists (
        in ModelManagement::Package package,
        in ElementImport element_import)
        raises (Reflective::MofError);
    ModelManagement::Package package (in ElementImport element_import)
        raises (Reflective::MofError);
    ElementImportSet element_import (in ModelManagement::Package package)
        raises (Reflective::MofError);
    void add (
        in ModelManagement::Package package,
        in ElementImport element_import)
        raises (Reflective::MofError);
    void modify_package (
        in ModelManagement::Package package,
        in ElementImport element_import,
        in ModelManagement::Package new_package)
        raises (Reflective::NotFound, Reflective::MofError);
    void modify_element_import (
        in ModelManagement::Package package,
        in ElementImport element_import,
        in ElementImport new_element_import)
        raises (Reflective::NotFound, Reflective::MofError);
    void remove (
        in ModelManagement::Package package,
        in ElementImport element_import)
        raises (Reflective::NotFound, Reflective::MofError);
}; // end of interface APackageElementImport
```

```
interface ModelManagementPackageFactory
{
  ModelManagementPackage create_model_management_package ()
    raises (Reflective::MofError);
};

interface ModelManagementPackage : Reflective::RefPackage
{
  readonly attribute ModelClass model_ref;
  readonly attribute PackageClass package_ref;
  readonly attribute SubsystemClass subsystem_ref;
  readonly attribute ElementImportClass element_import_ref;
  readonly attribute AModelElementElementImport a_model_element_element_import_ref;
  readonly attribute APackageElementImport a_package_element_import_ref;
};
};
```

5 UML CORBAfacility InterfaceDefinition

This chapter specifies the XMI DTD for UML 1.3 and the physical metamodel from which it was generated.

Contents

6.1 Overview	6-3
6.2 Physical Metamodel	6-3
6.3 UML XMI DTD	6-23

6 UML XMI DTD Specification

6.1 Overview

The OMG XMI standard specifies a structure for interchanging models that uses XML. The XMI DTD generated for UML is a physical mechanism for interchanging UML models conforming to the UML metamodel.

Section 6.2 contains the physical metamodel for UML from which the DTD was generated, as well as a list of the changes required to produce the metamodel. Section 6.3 contains a normative DTD that represents the UML 1.3 metamodel generated from the XMI 1.0 specification.

One of the primary goals of providing this DTD is to advance the state of the industry by enabling OO modeling tool interoperability, now available through XMI. When interchanging UML models via streams or files, this normative XMI DTD should be used.

6.2 Physical Metamodel

The physical metamodel is the representation of the abstract syntax with minor modifications to support generation of an XMI DTD. The following changes were made to the UML abstract syntax:

Names

- Changed spaces in package names to '_'.
- Added names for association ends that did not have them. Convention: the name of the adjoining class with the first letter in lower case. If this resulted in a name duplication, then a numbered suffix was added.

Additions

- Added enumeration literals as attributes of the enumeration classes for enumeration data types.
- Added 'sorted' enumeration literal to OrderingKind.
- Added inheritance link from Message to ModelElement.

Association Classes

- Made ElementOwnership AssociationClass attributes by moving the visibility and isSpecification attributes to the ModelElement class.
- Removed the attribute "visibility" from classes AssociationEnd and Feature.
- Made the AssociationClass ElementResidence a class by removing the association between Component and ModelElement and adding associations between ElementResidence and Component and between ElementResidence and ModelElement.

6 UML XMI DTD Specification

- Made the AssociationClass ElementImport a class by removing the association between ModelElement and Package and adding associations between ModelElement and ElementImport and between ElementImport and Package.
- Made the AssociationClass TemplateParameter a class by removing the association between ModelElement and ModelElement for template parameters and added associations between ModelElement and TemplateParameter and between TemplateParameter and ModelElement.

MOF stereotypes

- Added CORBA typecodes to the DataTypes in the MOF tab of the model.
- Added a dataType Geometry as tk_string
- Changed "LocationReference", "Mapping", "Name" as tk_string
- Moved The Link between ModelElement & TaggedValue from "Core" to package "Extension_Mechanisms"
- Removed the duplicate Aggregation between Binding & ModelElement from package "Core"
- Relocated the following Associations to package "Activity_Graphs", A_parameter_state (between class "Parameter" and "ObjectFlowState"), A_type_classifierInState (between classes "Classifier" and "ClassifierInState"), A_contents_partition (between ModelElement and Partition), A_activityGraph_partition (between ActivityGraph and Partition), A_type_objectFlowState (between Classifier and ObjectFlowState), A_classifierInState_inState (between ClassifierInState and State)
- Removed Association names "association", "guard", "h", "Instantiation" and "Parameters"
- Changed the name of the role for the Association between classes "Component" and "ElementResidence", A_implementationLocation_elementResidence to A_implementationLocation_residentElement .
- Changed the Cardinality for role "constrainedElement" from 1..n to 0..n (in A_constrainedElement_constraint) and for role "constrainedElement2" from 1 to 0..1 for A_constrainedElement2_stereotypeConstraint
- Removed "ordered" in Role "structuralFeature" of association A_structuralFeature_type.

6.2 Physical Metamodel

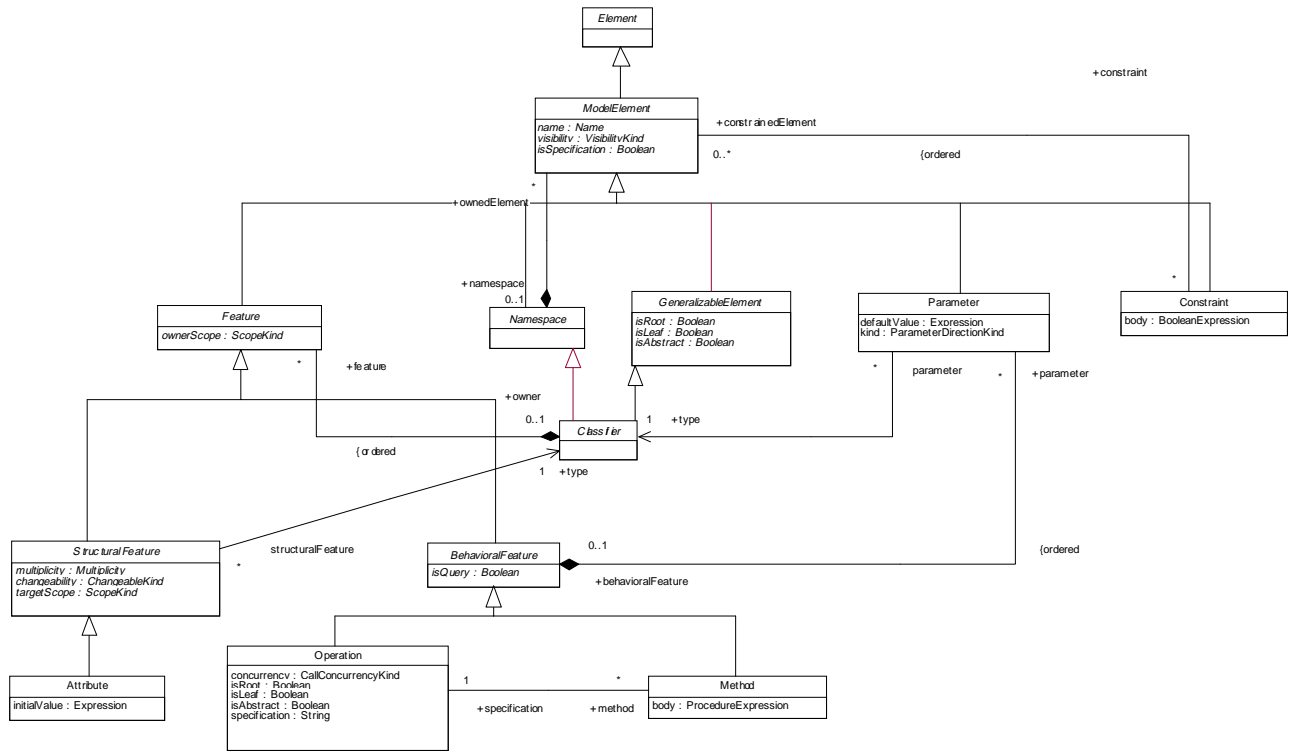

Figure 6-1 Backbone

6 UML XMI DTD Specification

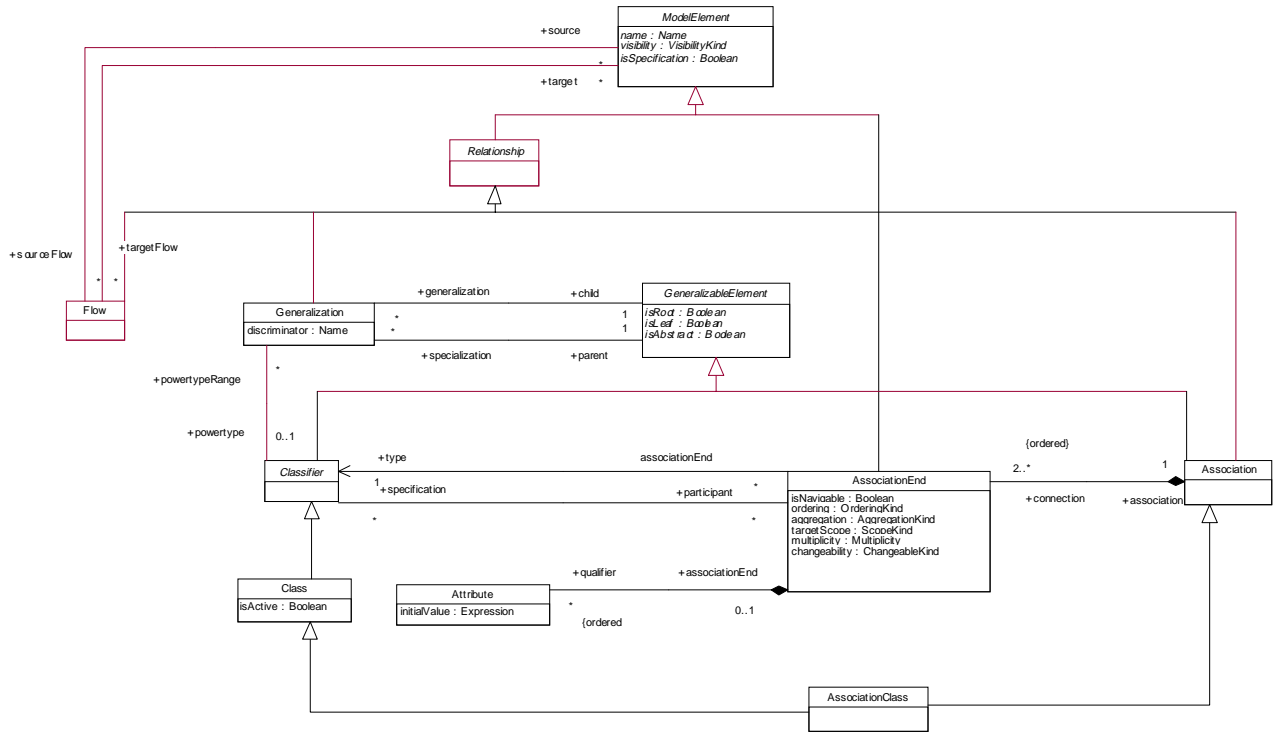

Figure 6-2 Relationships

6.2 Physical Metamodel

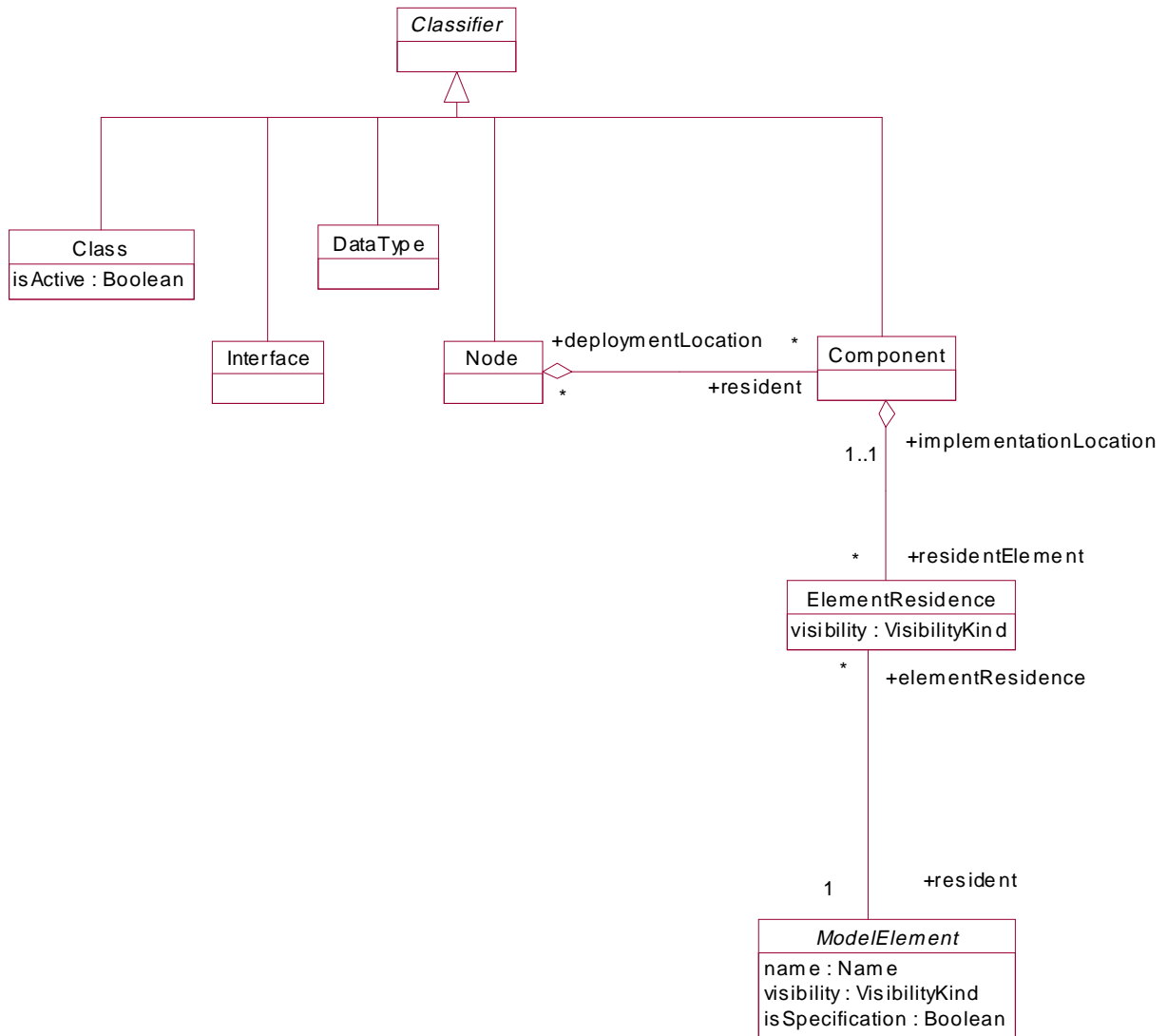

Figure 6-3 Classifiers

6 UML XMI DTD Specification

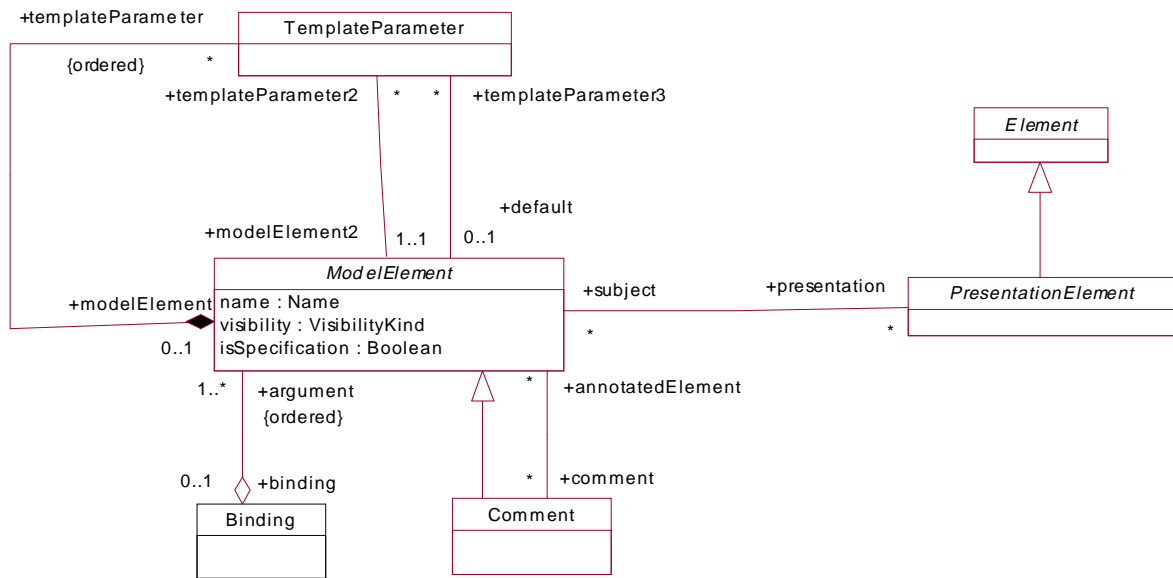

Figure 6-4 Auxilliary Elements

6.2 Physical Metamodel

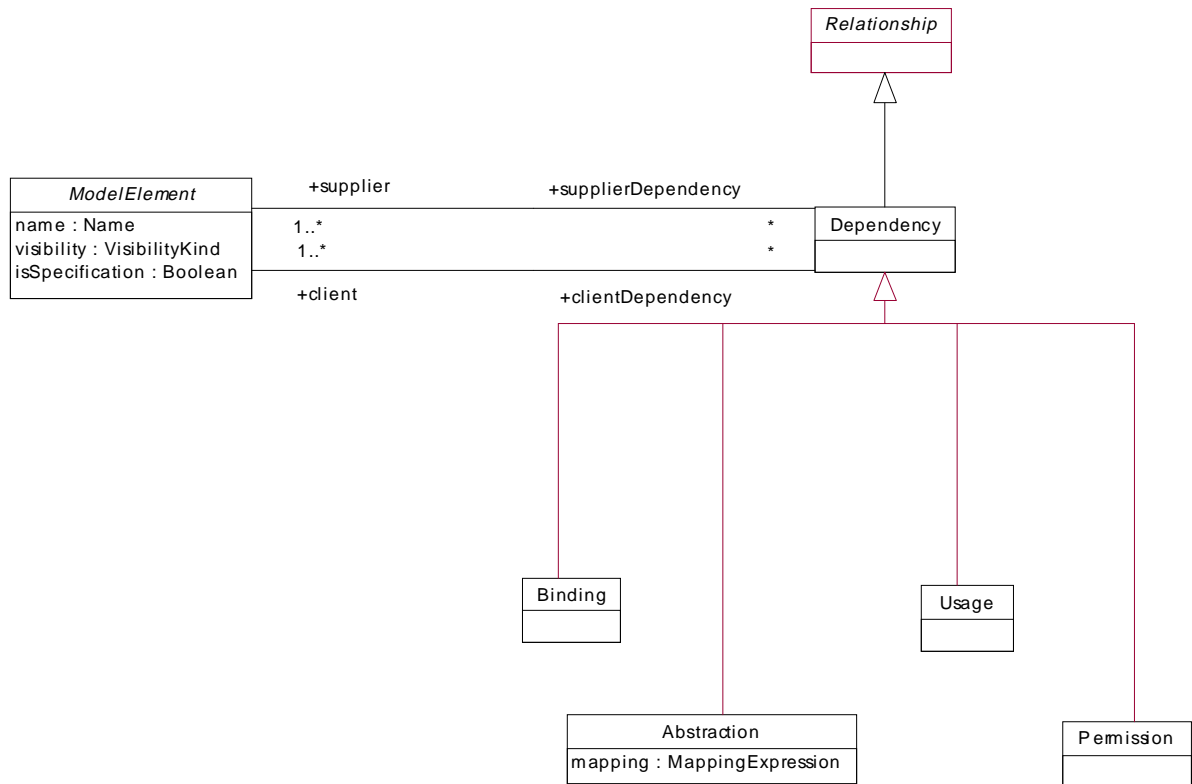

Figure 6-5 Dependencies

6 UML XMI DTD Specification

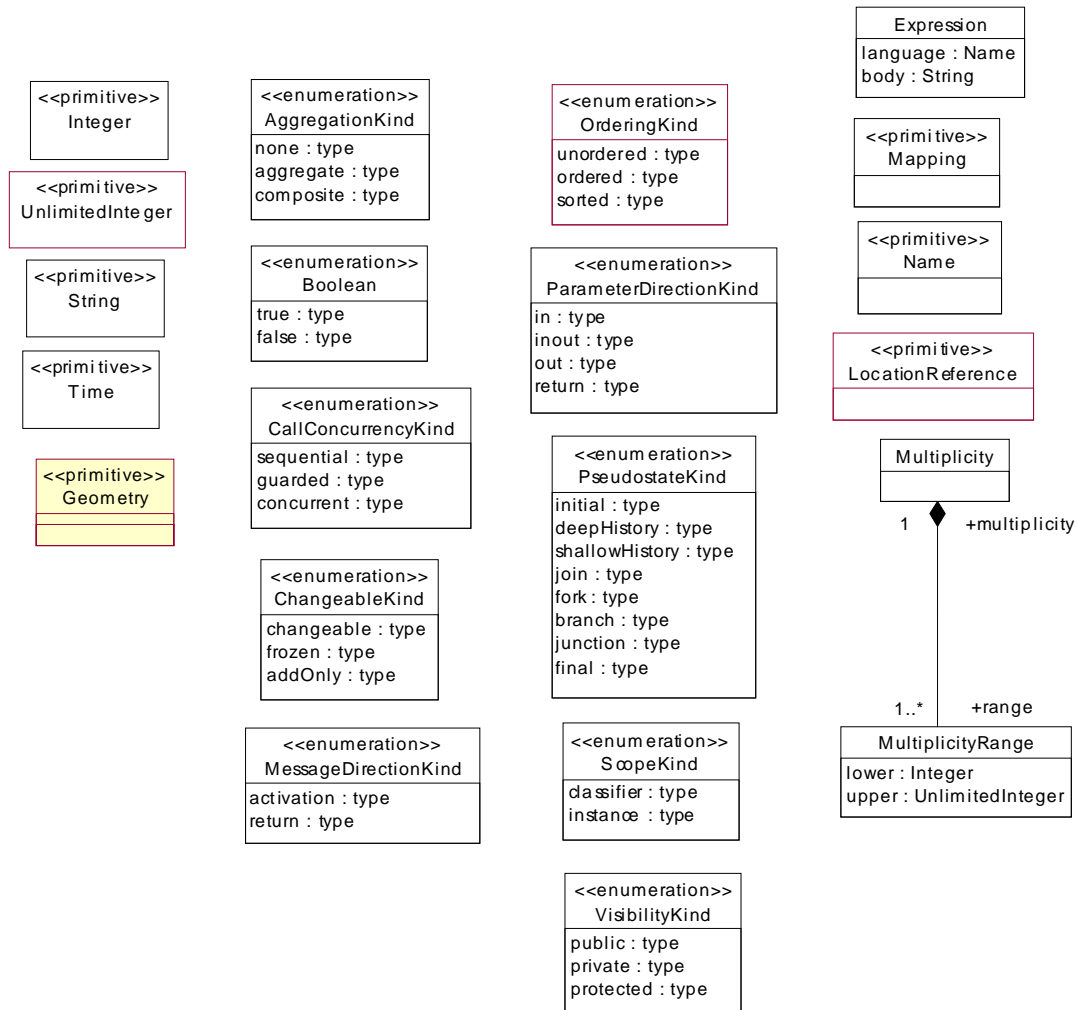

Figure 6-6 Data Types

6.2 Physical Metamodel

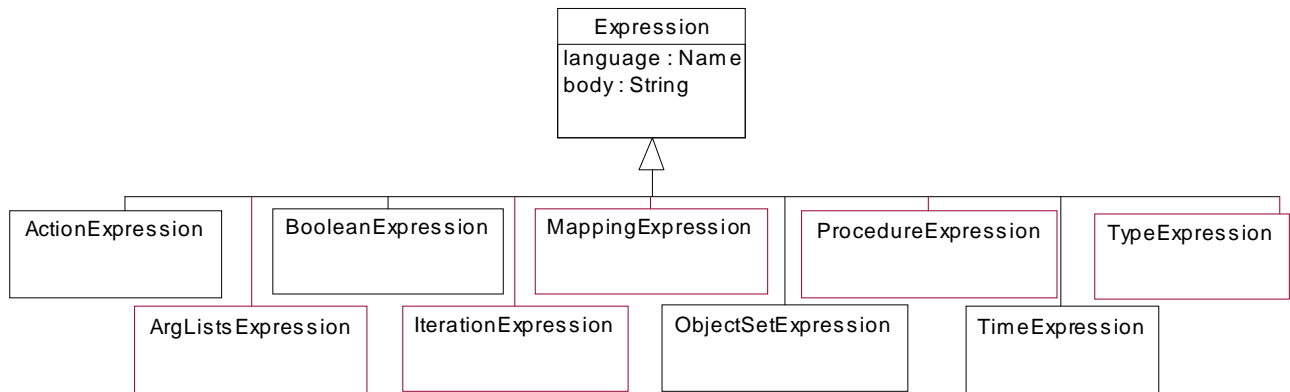

Figure 6-7 Expressions

6 UML XMI DTD Specification

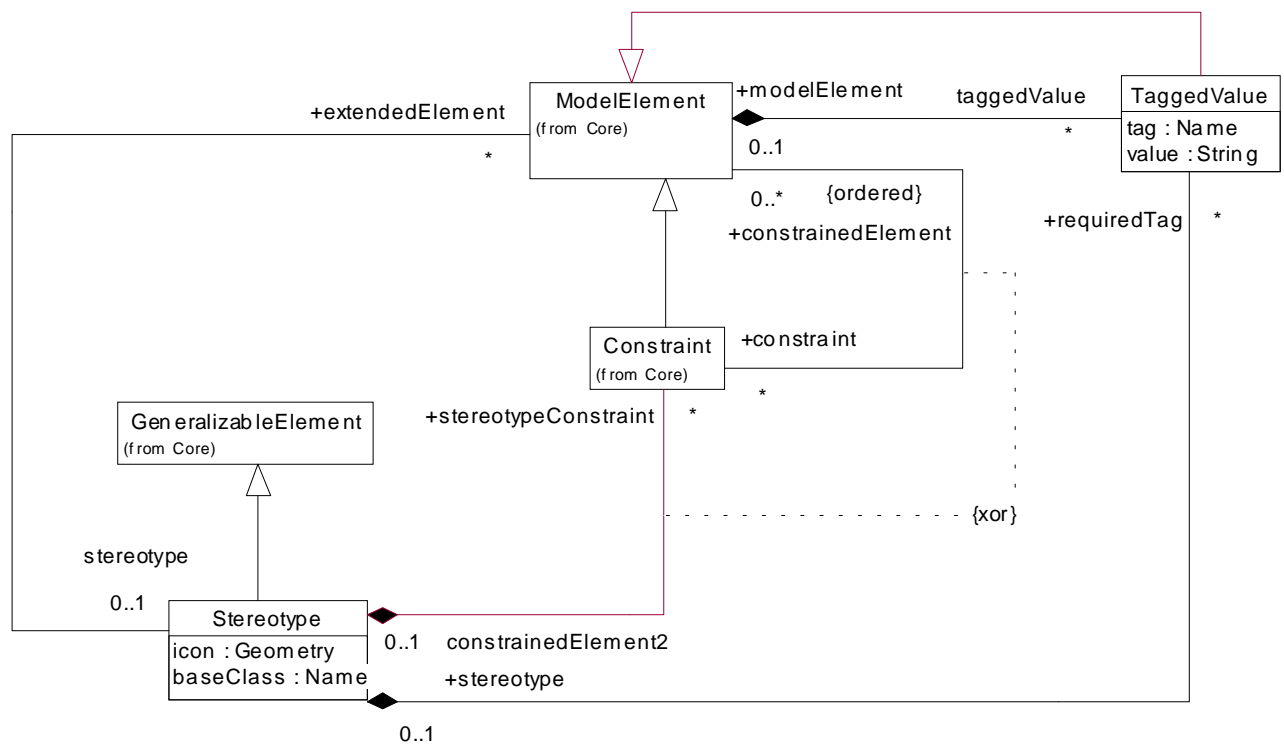

Figure 6-8 Extension Mechanisms

6.2 Physical Metamodel

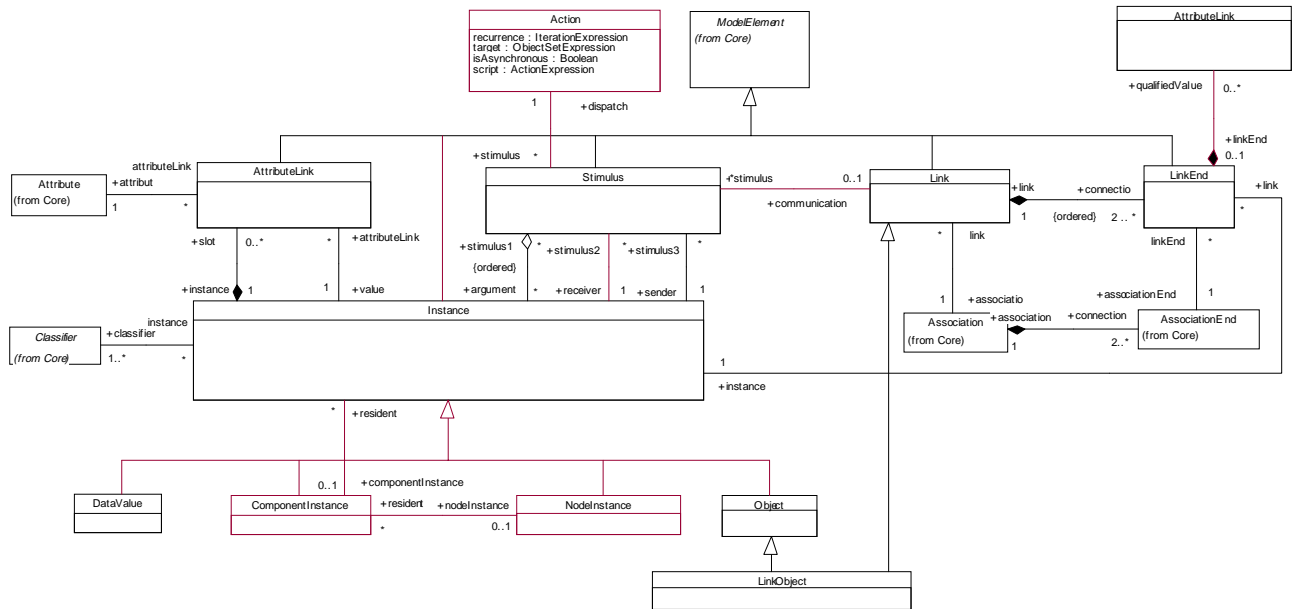

Figure 6-9 Instances

6 UML XMI DTD Specification

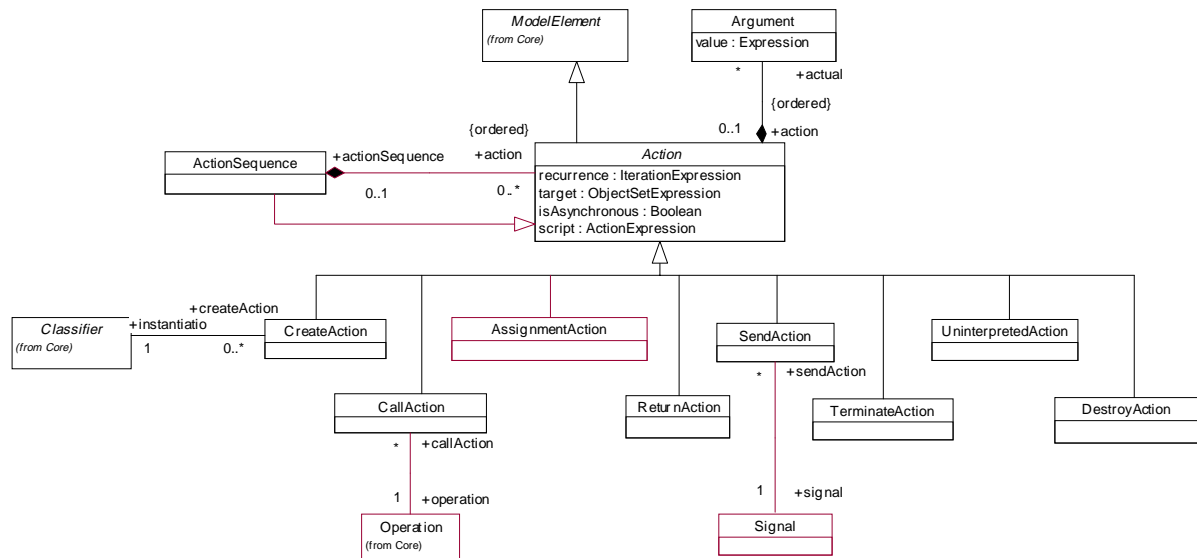

Figure 6-10 Actions

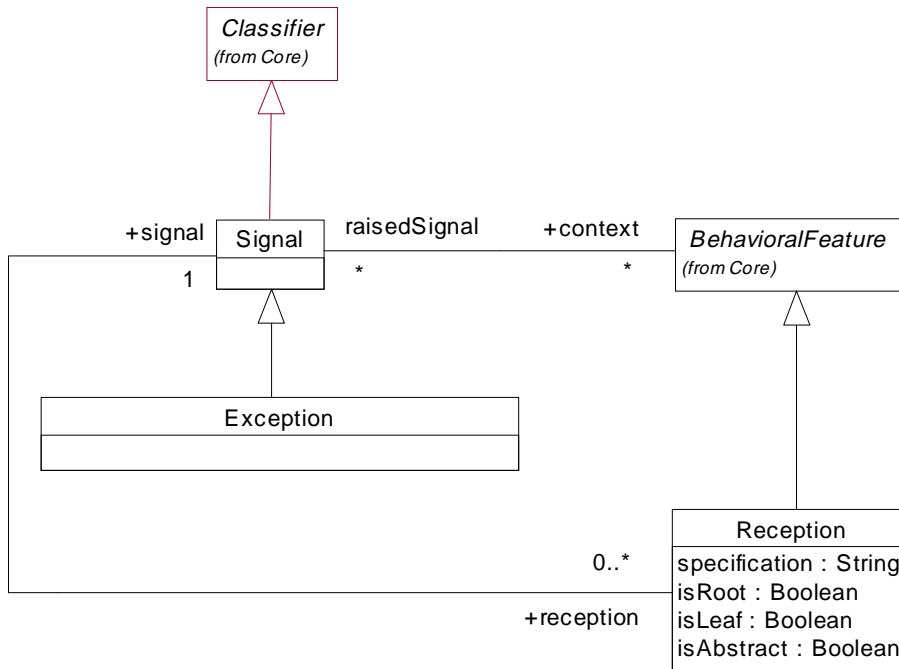

Figure 6-11 Signals

6 UML XMI DTD Specification

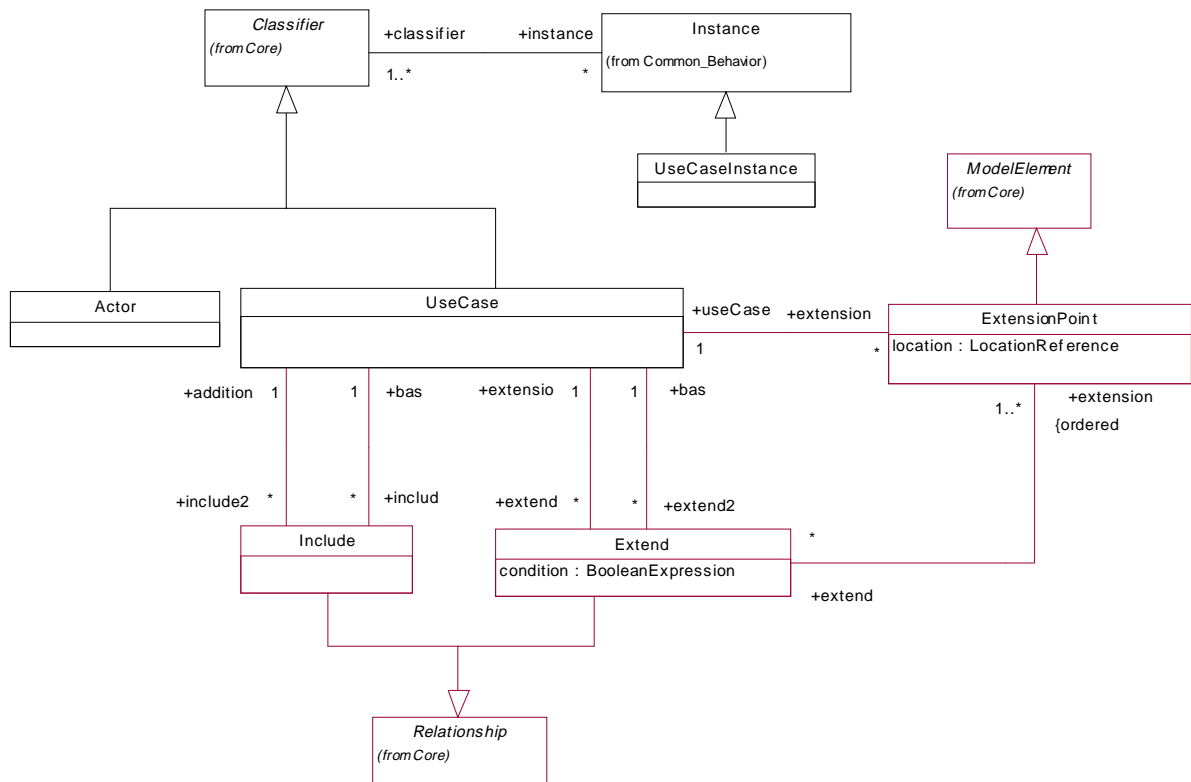

Figure 6-12 Use Cases

6.2 Physical Metamodel

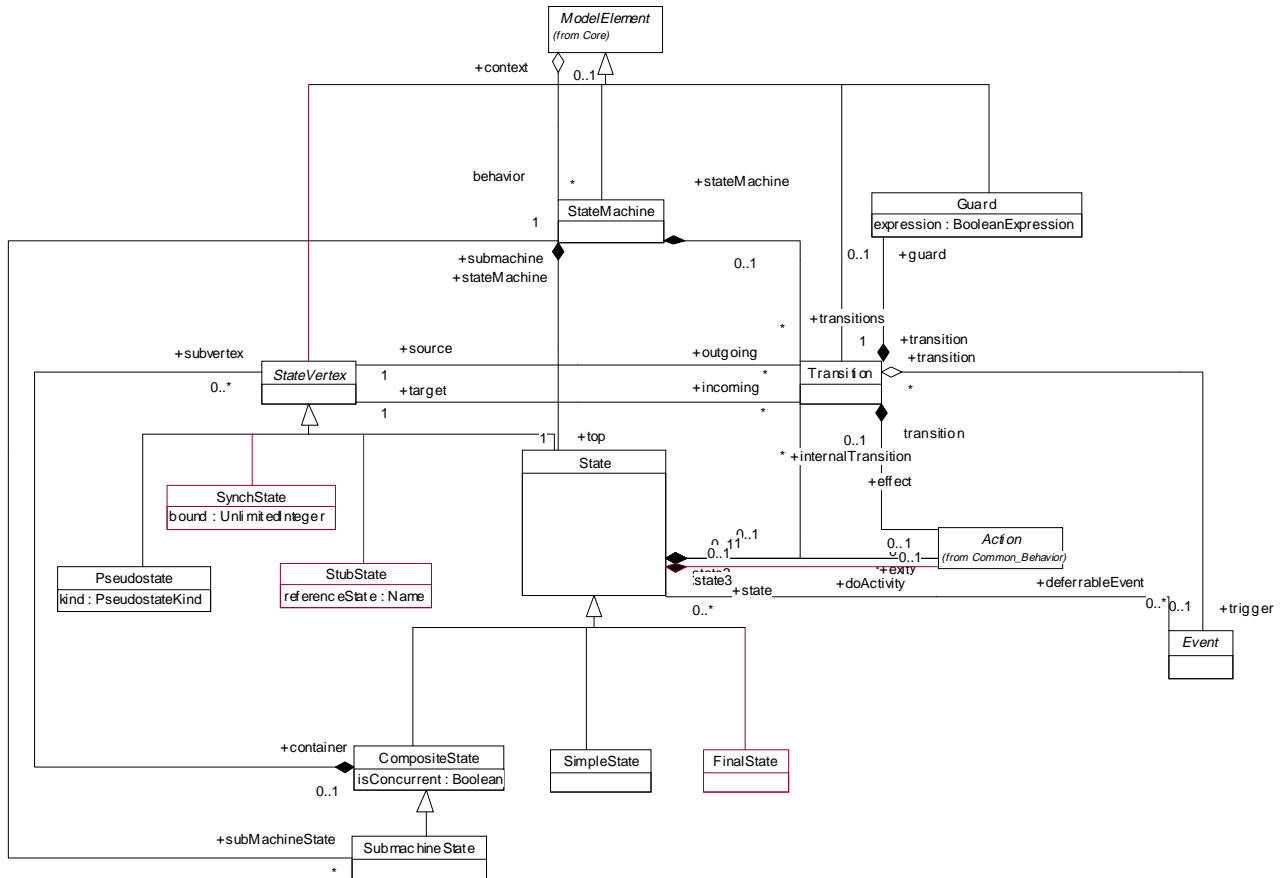

Figure 6-13 State Machines

6 UML XMI DTD Specification

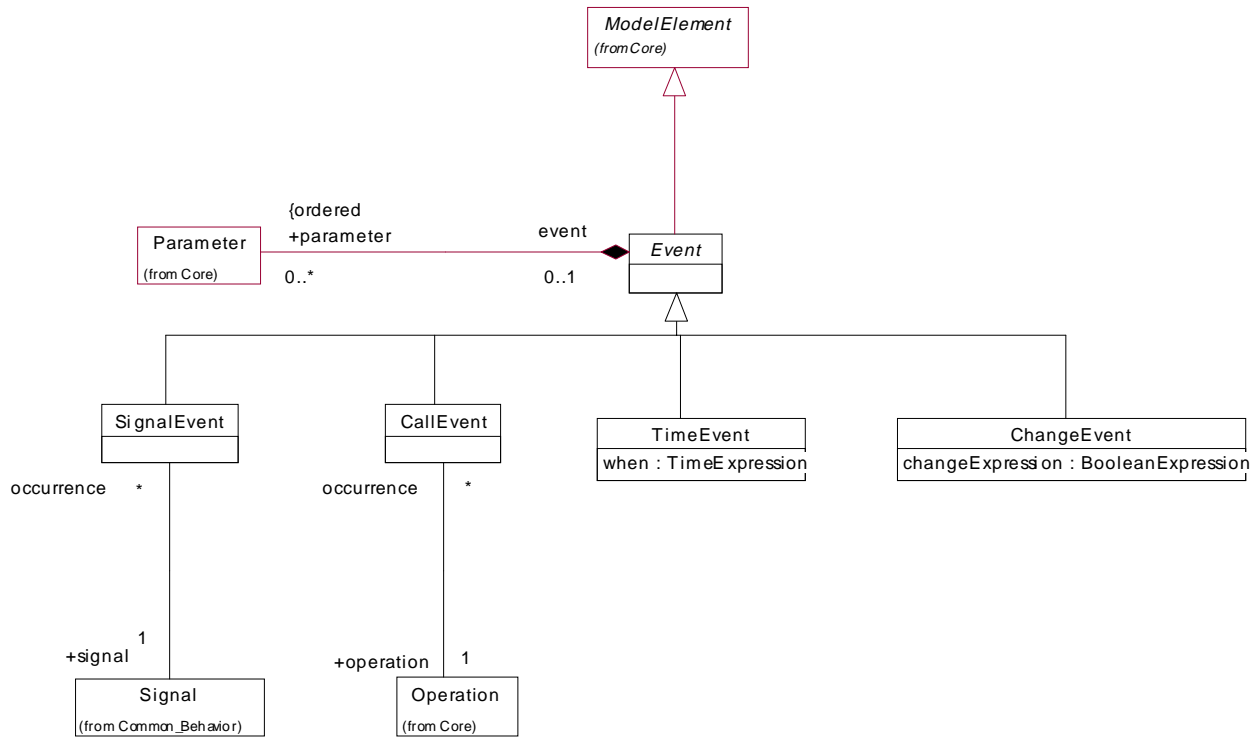

Figure 6-14 Events

6.2 Physical Metamodel

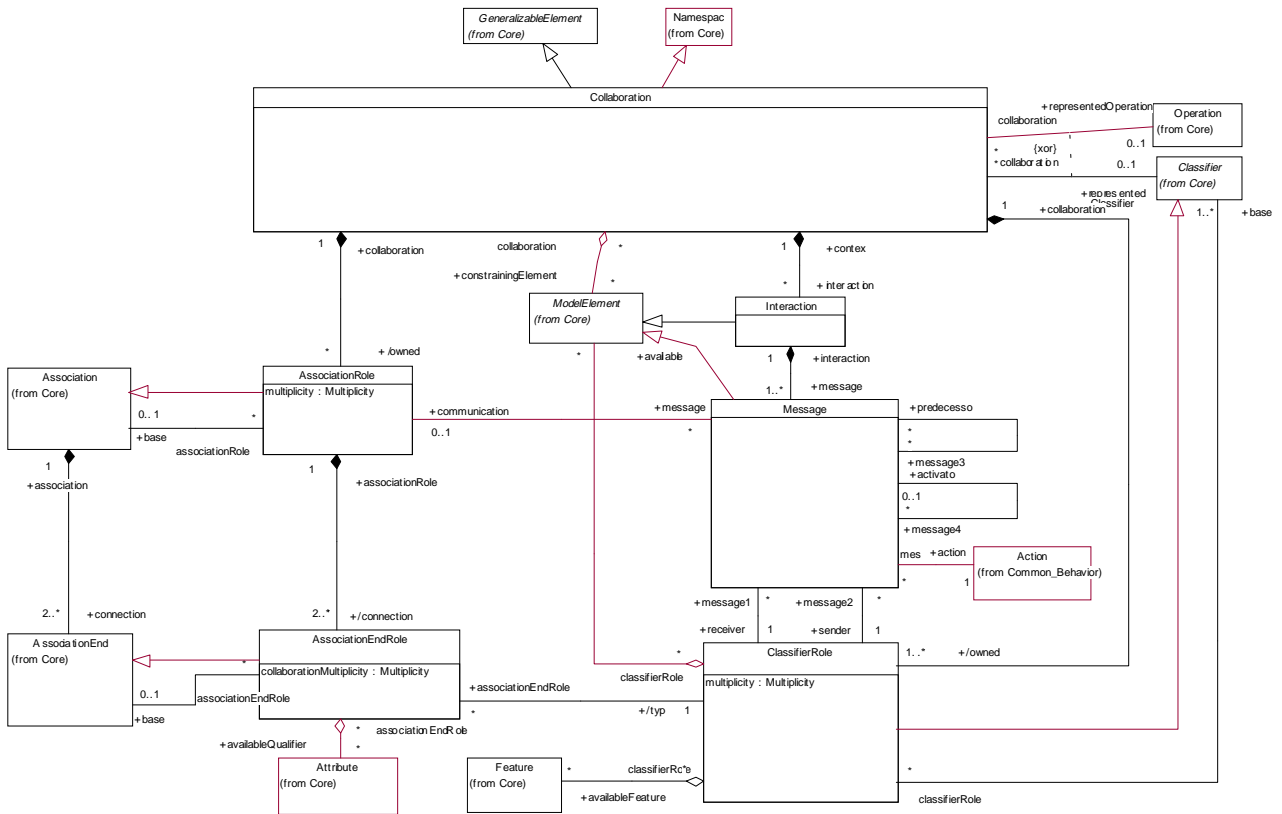

Figure 6-15 Collaborations

6 UML XMI DTD Specification

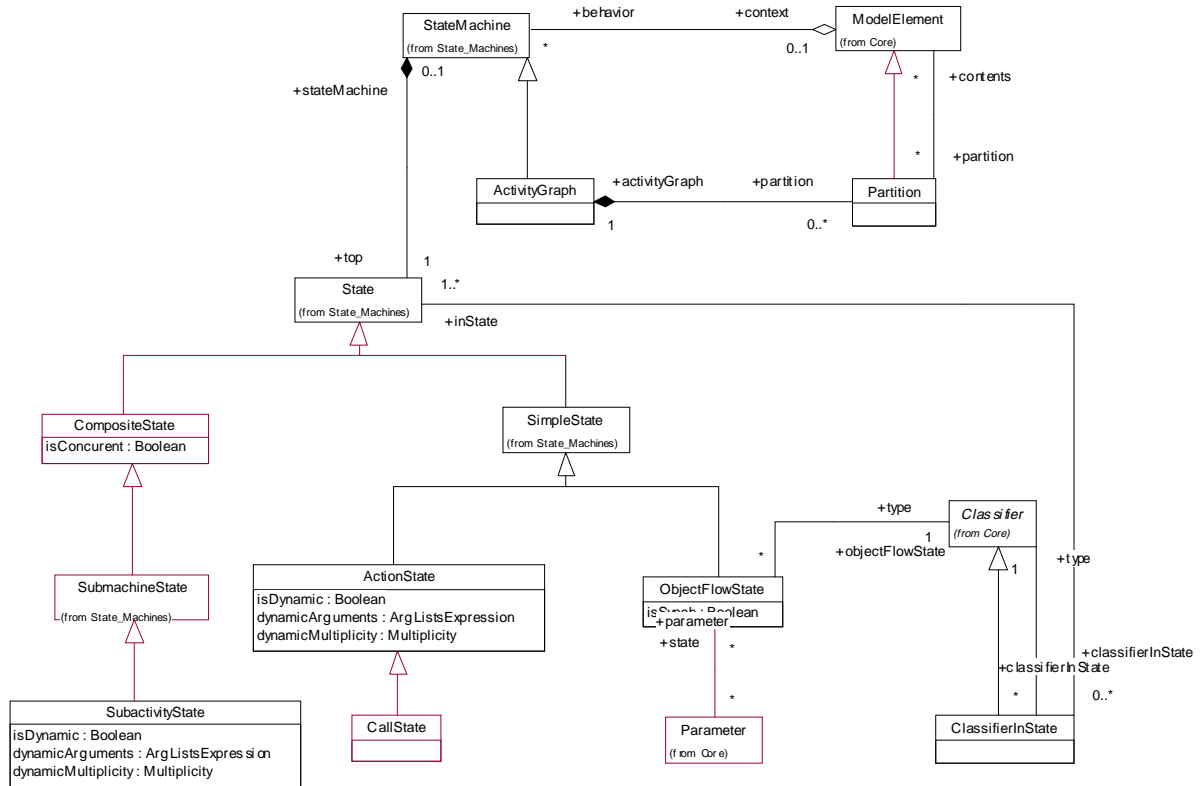

Figure 6-16 Activity Graphs

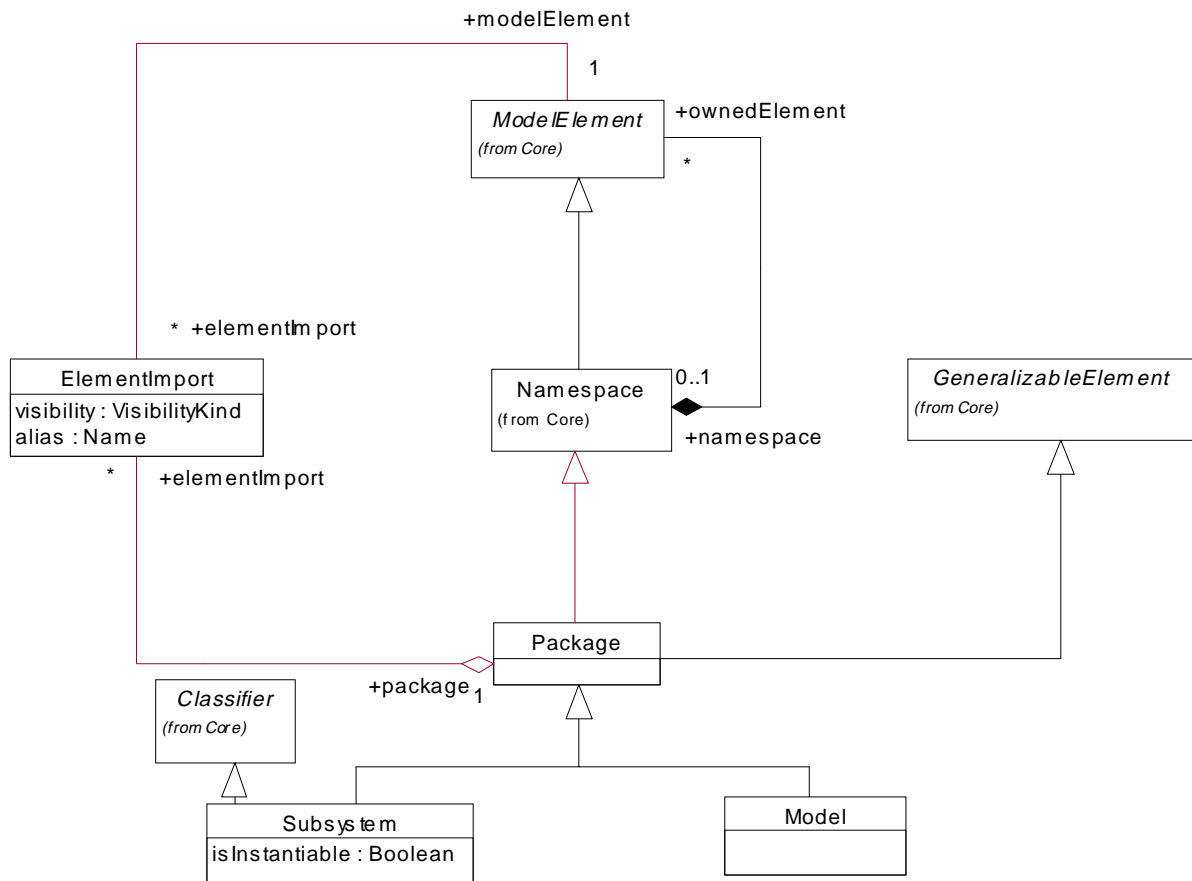

Figure 6-17 Model Management

6 UML XMI DTD Specification

6.3 UML XMI DTD

```

<?xml version="1.0" encoding="UTF-8" ?>
<!-- XMI Automatic DTD Generation -->
<!-- Date: Fri May 28 14:48:41 PDT 1999 -->
<!-- Metamodel: UML1.3 -->

<!-- _____ -->
<!-- -->
<!-- XMI is the top-level XML element for XMI transfer text -->
<!-- _____ -->

<!ELEMENT XMI (XMI.header, XMI.content?, XMI.difference*,
              XMI.extensions*) >
<!ATTLIST XMI
          xmi.version CDATA #FIXED "1.0"
          timestamp CDATA #IMPLIED
          verified (true | false) #IMPLIED
>

<!-- _____ -->
<!-- -->
<!-- XMI.header contains documentation and identifies the model, -->
<!-- metamodel, and metamodel -->
<!-- _____ -->

<!ELEMENT XMI.header (XMI.documentation?, XMI.model*, XMI.metamodel*,
                    XMI.metamodel*) >

<!-- _____ -->
<!-- -->
<!-- documentation for transfer data -->
<!-- _____ -->

<!ELEMENT XMI.documentation (#PCDATA | XMI.owner | XMI.contact |
                             XMI.longDescription | XMI.shortDescription |
                             XMI.exporter | XMI.exporterVersion |
                             XMI.notice)* >

<!ELEMENT XMI.owner ANY >

<!ELEMENT XMI.contact ANY >

<!ELEMENT XMI.longDescription ANY >

<!ELEMENT XMI.shortDescription ANY >

<!ELEMENT XMI.exporter ANY >

<!ELEMENT XMI.exporterVersion ANY >

<!ELEMENT XMI.exporterID ANY >

<!ELEMENT XMI.notice ANY >

<!-- _____ -->
<!-- -->
<!-- XMI.element.att defines the attributes that each XML element -->
<!-- that corresponds to a metamodel class must have to conform to -->
<!-- the XMI specification. -->
<!-- _____ -->

```

6 UML XMI DTD Specification

```
<!ENTITY % XMI.element.att
    'xmi.id ID #IMPLIED xmi.label CDATA #IMPLIED xmi.uuid
    CDATA #IMPLIED ' >

<!-- ----- -->
<!-- ----- -->
<!-- XMI.link.att defines the attributes that each XML element that -->
<!-- corresponds to a metamodel class must have to enable it to -->
<!-- function as a simple XLink as well as refer to model -->
<!-- constructs within the same XMI file. -->
<!-- ----- -->

<!ENTITY % XMI.link.att
    'xmi:link CDATA #IMPLIED inline (true | false) #IMPLIED
    actuate (show | user) #IMPLIED href CDATA #IMPLIED role
    CDATA #IMPLIED title CDATA #IMPLIED show (embed | replace
    | new) #IMPLIED behavior CDATA #IMPLIED xmi.idref IDREF
    #IMPLIED xmi.uuidref CDATA #IMPLIED' >

<!-- ----- -->
<!-- ----- -->
<!-- XMI.model identifies the model(s) being transferred -->
<!-- ----- -->

<!ELEMENT XMI.model ANY >
<!ATTLIST XMI.model
    %XMI.link.att;
    xmi.name CDATA #REQUIRED
    xmi.version CDATA #IMPLIED
>

<!-- ----- -->
<!-- ----- -->
<!-- XMI.metamodel identifies the metamodel(s) for the transferred -->
<!-- data -->
<!-- ----- -->

<!ELEMENT XMI.metamodel ANY >
<!ATTLIST XMI.metamodel
    %XMI.link.att;
    xmi.name CDATA #REQUIRED
    xmi.version CDATA #IMPLIED
>

<!-- ----- -->
<!-- ----- -->
<!-- XMI.metametamodel identifies the metametamodel(s) for the -->
<!-- transferred data -->
<!-- ----- -->

<!ELEMENT XMI.metametamodel ANY >
<!ATTLIST XMI.metametamodel
    %XMI.link.att;
    xmi.name CDATA #REQUIRED
    xmi.version CDATA #IMPLIED
>

<!-- ----- -->
<!-- ----- -->
<!-- XMI.content is the actual data being transferred -->
<!-- ----- -->

<!ELEMENT XMI.content ANY >

<!-- ----- -->
<!-- ----- -->
<!-- XMI.extensions contains data to transfer that does not conform -->
<!-- to the metamodel(s) in the header -->
```

```

<!-- _____ -->

<!ELEMENT XMI.extensions ANY >
<!ATTLIST XMI.extensions
    xmi.extender CDATA #REQUIRED
>

<!-- _____ -->
<!-- _____ -->
<!-- extension contains information related to a specific model -->
<!-- construct that is not defined in the metamodel(s) in the header -->
<!-- _____ -->

<!ELEMENT XMI.extension ANY >
<!ATTLIST XMI.extension
    %XMI.element.att;
    %XMI.link.att;
    xmi.extender CDATA #REQUIRED
    xmi.extenderID CDATA #REQUIRED
>

<!-- _____ -->
<!-- _____ -->
<!-- XMI.difference holds XML elements representing differences to a -->
<!-- base model -->
<!-- _____ -->

<!ELEMENT XMI.difference (XMI.difference | XMI.delete | XMI.add |
    XMI.replace)* >
<!ATTLIST XMI.difference
    %XMI.element.att;
    %XMI.link.att;
>

<!-- _____ -->
<!-- _____ -->
<!-- XMI.delete represents a deletion from a base model -->
<!-- _____ -->

<!ELEMENT XMI.delete EMPTY >
<!ATTLIST XMI.delete
    %XMI.element.att;
    %XMI.link.att;
>

<!-- _____ -->
<!-- _____ -->
<!-- XMI.add represents an addition to a base model -->
<!-- _____ -->

<!ELEMENT XMI.add ANY >
<!ATTLIST XMI.add
    %XMI.element.att;
    %XMI.link.att;
    xmi.position CDATA "-1"
>

<!-- _____ -->
<!-- _____ -->
<!-- XMI.replace represents the replacement of a model construct -->
<!-- with another model construct in a base model -->
<!-- _____ -->

<!ELEMENT XMI.replace ANY >
<!ATTLIST XMI.replace
    %XMI.element.att;
    %XMI.link.att;
    xmi.position CDATA "-1"

```

6 UML XMI DTD Specification

```
>

<!-- _____ -->
<!-- _____ -->
<!-- XMI.reference may be used to refer to data types not defined in -->
<!-- the metamodel -->
<!-- _____ -->

<!ELEMENT XMI.reference ANY >
<!ATTLIST XMI.reference
    %XMI.link.att;
>

<!-- _____ -->
<!-- _____ -->
<!-- This section contains the declaration of XML elements -->
<!-- representing data types -->
<!-- _____ -->

<!ELEMENT XMI.TypeDefinitions ANY >

<!ELEMENT XMI.field ANY >

<!ELEMENT XMI.seqItem ANY >

<!ELEMENT XMI.octetStream (#PCDATA) >

<!ELEMENT XMI.unionDiscrim ANY >

<!ELEMENT XMI.enum EMPTY >
<!ATTLIST XMI.enum
    xmi.value CDATA #REQUIRED
>

<!ELEMENT XMI.any ANY >
<!ATTLIST XMI.any
    %XMI.link.att;
    xmi.type CDATA #IMPLIED
    xmi.name CDATA #IMPLIED
>

<!ELEMENT XMI.CorbaTypeCode (XMI.CorbaTcAlias | XMI.CorbaTcStruct |
    XMI.CorbaTcSequence | XMI.CorbaTcArray |
    XMI.CorbaTcEnum | XMI.CorbaTcUnion |
    XMI.CorbaTcExcept | XMI.CorbaTcString |
    XMI.CorbaTcWstring | XMI.CorbaTcShort |
    XMI.CorbaTcLong | XMI.CorbaTcUshort |
    XMI.CorbaTcUlong | XMI.CorbaTcFloat |
    XMI.CorbaTcDouble | XMI.CorbaTcBoolean |
    XMI.CorbaTcChar | XMI.CorbaTcWchar |
    XMI.CorbaTcOctet | XMI.CorbaTcAny |
    XMI.CorbaTcTypeCode | XMI.CorbaTcPrincipal |
    XMI.CorbaTcNull | XMI.CorbaTcVoid |
    XMI.CorbaTcLongLong |
    XMI.CorbaTcLongDouble) >
<!ATTLIST XMI.CorbaTypeCode
    %XMI.element.att;
>

<!ELEMENT XMI.CorbaTcAlias (XMI.CorbaTypeCode) >
<!ATTLIST XMI.CorbaTcAlias
    xmi.tcName CDATA #REQUIRED
    xmi.tcId CDATA #IMPLIED
>

<!ELEMENT XMI.CorbaTcStruct (XMI.CorbaTcField)* >
<!ATTLIST XMI.CorbaTcStruct
    xmi.tcName CDATA #REQUIRED
```



```

        xmi.tcId    CDATA #IMPLIED
    >

<!ELEMENT XMI.CorbaTcField (XMI.CorbaTypeCode) >
<!ATTLIST XMI.CorbaTcField
        xmi.tcName CDATA #REQUIRED
    >

<!ELEMENT XMI.CorbaTcSequence (XMI.CorbaTypeCode |
                                XMI.CorbaRecursiveType) >
<!ATTLIST XMI.CorbaTcSequence
        xmi.tcLength CDATA #REQUIRED
    >

<!ELEMENT XMI.CorbaRecursiveType EMPTY >
<!ATTLIST XMI.CorbaRecursiveType
        xmi.offset CDATA #REQUIRED
    >

<!ELEMENT XMI.CorbaTcArray (XMI.CorbaTypeCode) >
<!ATTLIST XMI.CorbaTcArray
        xmi.tcLength CDATA #REQUIRED
    >

<!ELEMENT XMI.CorbaTcObjRef EMPTY >
<!ATTLIST XMI.CorbaTcObjRef
        xmi.tcName CDATA #REQUIRED
        xmi.tcId    CDATA #IMPLIED
    >

<!ELEMENT XMI.CorbaTcEnum (XMI.CorbaTcEnumLabel) >
<!ATTLIST XMI.CorbaTcEnum
        xmi.tcName CDATA #REQUIRED
        xmi.tcId    CDATA #IMPLIED
    >

<!ELEMENT XMI.CorbaTcEnumLabel EMPTY >
<!ATTLIST XMI.CorbaTcEnumLabel
        xmi.tcName CDATA #REQUIRED
    >

<!ELEMENT XMI.CorbaTcUnionMbr (XMI.CorbaTypeCode, XMI.any) >
<!ATTLIST XMI.CorbaTcUnionMbr
        xmi.tcName CDATA #REQUIRED
    >

<!ELEMENT XMI.CorbaTcUnion (XMI.CorbaTypeCode, XMI.CorbaTcUnionMbr*) >
<!ATTLIST XMI.CorbaTcUnion
        xmi.tcName CDATA #REQUIRED
        xmi.tcId    CDATA #IMPLIED
    >

<!ELEMENT XMI.CorbaTcExcept (XMI.CorbaTcField)* >
<!ATTLIST XMI.CorbaTcExcept
        xmi.tcName CDATA #REQUIRED
        xmi.tcId    CDATA #IMPLIED
    >

<!ELEMENT XMI.CorbaTcString EMPTY >
<!ATTLIST XMI.CorbaTcString
        xmi.tcLength CDATA #REQUIRED
    >

<!ELEMENT XMI.CorbaTcWstring EMPTY >
<!ATTLIST XMI.CorbaTcWstring
        xmi.tcLength CDATA #REQUIRED
    >

```

6 UML XMI DTD Specification

```
<!ELEMENT XMI.CorbaTcFixed EMPTY >
<!ATTLIST XMI.CorbaTcFixed
    xmi.tcDigits CDATA #REQUIRED
    xmi.tcScale CDATA #REQUIRED
>

<!ELEMENT XMI.CorbaTcShort EMPTY >

<!ELEMENT XMI.CorbaTcLong EMPTY >

<!ELEMENT XMI.CorbaTcUshort EMPTY >

<!ELEMENT XMI.CorbaTcUlong EMPTY >

<!ELEMENT XMI.CorbaTcFloat EMPTY >

<!ELEMENT XMI.CorbaTcDouble EMPTY >

<!ELEMENT XMI.CorbaTcBoolean EMPTY >

<!ELEMENT XMI.CorbaTcChar EMPTY >

<!ELEMENT XMI.CorbaTcWchar EMPTY >

<!ELEMENT XMI.CorbaTcOctet EMPTY >

<!ELEMENT XMI.CorbaTcAny EMPTY >

<!ELEMENT XMI.CorbaTcTypeCode EMPTY >

<!ELEMENT XMI.CorbaTcPrincipal EMPTY >

<!ELEMENT XMI.CorbaTcNull EMPTY >

<!ELEMENT XMI.CorbaTcVoid EMPTY >

<!ELEMENT XMI.CorbaTcLongLong EMPTY >

<!ELEMENT XMI.CorbaTcLongDouble EMPTY >

<!-- _____ -->
<!-- _____ -->
<!-- METAMODEL: UML1.3 _____ -->
<!-- _____ -->

<!-- _____ -->
<!-- _____ -->
<!-- METAMODEL PACKAGE: Foundation _____ -->
<!-- _____ -->

<!-- _____ -->
<!-- _____ -->
<!-- METAMODEL PACKAGE: Core _____ -->
<!-- _____ -->

<!ELEMENT Foundation.Core.Association.connection (Foundation.Core.AssociationEnd |
    Behavioral_Elements.Collaborations.AssociationEndRole)*
>

<!ELEMENT Foundation.Core.Classifier.feature (Foundation.Core.Feature |
    Foundation.Core.BehavioralFeature |
    Behavioral_Elements.Common_Behavior.Reception |
    Foundation.Core.Operation |
    Foundation.Core.Method |
    Foundation.Core.StructuralFeature |
```

```

Foundation.Core.Attribute)*
>
<!ELEMENT Foundation.Core.Namespace.ownedElement (Foundation.Core.ModelElement |
Foundation.Core.Comment |
Foundation.Core.Relationship |
Behavioral_Elements.Use_Cases.Extend |
Behavioral_Elements.Use_Cases.Include |
Foundation.Core.Generalization |
Foundation.Core.Flow |
Foundation.Core.Association |
Foundation.Core.AssociationClass |
Behavioral_Elements.Collaborations.AssociationRole |
Foundation.Core.Dependency |
Foundation.Core.Abstraction |
Foundation.Core.Usage |
Foundation.Core.Binding |
Foundation.Core.Permission |
Foundation.Extension_Mechanisms.TaggedValue |
Behavioral_Elements.Common_Behavior.Instance |
Behavioral_Elements.Common_Behavior.Object |
Behavioral_Elements.Common_Behavior.LinkObject |
Behavioral_Elements.Common_Behavior.DataValue |
Behavioral_Elements.Common_Behavior.ComponentInstance |
Behavioral_Elements.Common_Behavior.NodeInstance |
Behavioral_Elements.Use_Cases.UseCaseInstance |
Behavioral_Elements.Common_Behavior.Action |
Behavioral_Elements.Common_Behavior.CallAction |
Behavioral_Elements.Common_Behavior.SendAction |
Behavioral_Elements.Common_Behavior.ActionSequence |
Behavioral_Elements.Common_Behavior.ReturnAction |
Behavioral_Elements.Common_Behavior.TerminateAction |
Behavioral_Elements.Common_Behavior.DestroyAction |
Behavioral_Elements.Common_Behavior.CreateAction |
Behavioral_Elements.Common_Behavior.UninterpretedAction |
Behavioral_Elements.Common_Behavior.AttributeLink |
Behavioral_Elements.Common_Behavior.Argument |
Behavioral_Elements.Common_Behavior.Link |
Behavioral_Elements.Common_Behavior.LinkEnd |
Behavioral_Elements.Common_Behavior.Stimulus |
Behavioral_Elements.Use_Cases.ExtensionPoint |
Behavioral_Elements.State_Machines.StateMachine |
Behavioral_Elements.Activity_Graphs.ActivityGraph |
Behavioral_Elements.State_Machines.Event |
Behavioral_Elements.State_Machines.TimeEvent |
Behavioral_Elements.State_Machines.CallEvent |
Behavioral_Elements.State_Machines.SignalEvent |
Behavioral_Elements.State_Machines.ChangeEvent |
Behavioral_Elements.State_Machines.Transition |
Behavioral_Elements.State_Machines.StateVertex |
Behavioral_Elements.State_Machines.Pseudostate |
Behavioral_Elements.State_Machines.SynchState |
Behavioral_Elements.State_Machines.StubState |
Behavioral_Elements.State_Machines.State |
Behavioral_Elements.State_Machines.CompositeState |
Behavioral_Elements.State_Machines.SubmachineState |
Behavioral_Elements.Activity_Graphs.SubactivityState |
Behavioral_Elements.State_Machines.SimpleState |
Behavioral_Elements.Activity_Graphs.ObjectFlowState |
Behavioral_Elements.Activity_Graphs.ActionState |
Behavioral_Elements.Activity_Graphs.CallState |
Behavioral_Elements.State_Machines.FinalState |
Behavioral_Elements.State_Machines.Guard |
Behavioral_Elements.Collaborations.Message |
Behavioral_Elements.Collaborations.Interaction |
Behavioral_Elements.Activity_Graphs.Partition |
Foundation.Core.Feature |
Foundation.Core.BehavioralFeature |

```

6 UML XMI DTD Specification

```
Behavioral_Elements.Common_Behavior.Reception |
Foundation.Core.Operation |
Foundation.Core.Method |
Foundation.Core.StructuralFeature |
Foundation.Core.Attribute |
Foundation.Core.GeneralizableElement |
Foundation.Extension_Mechanisms.Stereotype |
Behavioral_Elements.Collaborations.Collaboration |
Model_Management.Package |
Model_Management.Subsystem |
Model_Management.Model |
Foundation.Core.Classifier |
Foundation.Core.Class |
Foundation.Core.DataType |
Foundation.Core.Interface |
Foundation.Core.Component |
Foundation.Core.Node |
Behavioral_Elements.Common_Behavior.Signal |
Behavioral_Elements.Common_Behavior.Exception |
Behavioral_Elements.Use_Cases.UseCase |
Behavioral_Elements.Use_Cases.Actor |
Behavioral_Elements.Collaborations.ClassifierRole |
Behavioral_Elements.Activity_Graphs.ClassifierInState |
Foundation.Core.AssociationEnd |
Behavioral_Elements.Collaborations.AssociationEndRole |
Foundation.Core.Namespace |
Foundation.Core.Parameter |
Foundation.Core.Constraint)*
>

<!ELEMENT Foundation.Core.BehavioralFeature.parameter
      (Foundation.Core.Parameter)* >

<!ELEMENT Foundation.Core.AssociationEnd.qualified
      (Foundation.Core.Attribute)* >

<!ELEMENT Foundation.Core.ModelElement.templateParameter
      (Foundation.Core.TemplateParameter)* >

<!-- _____ -->
<!-- _____ -->
<!-- METAMODEL CLASS: Classifier -->
<!-- _____ -->

<!ELEMENT Foundation.Core.Classifier.participant (Foundation.Core.AssociationEnd |
      Behavioral_Elements.Collaborations.AssociationEndRole)*
>

<!ELEMENT Foundation.Core.Classifier.powertypeRange
      (Foundation.Core.Generalization)* >

<!ELEMENT Foundation.Core.Classifier.instance (Behavioral_Elements.Common_Behavior.Instance |
      Behavioral_Elements.Common_Behavior.Object |
      Behavioral_Elements.Common_Behavior.LinkObject |
      Behavioral_Elements.Common_Behavior.DataValue |
      Behavioral_Elements.Common_Behavior.ComponentInstance |
      Behavioral_Elements.Common_Behavior.NodeInstance |
      Behavioral_Elements.Use_Cases.UseCaseInstance)*
>

<!ELEMENT Foundation.Core.Classifier.createAction
      (Behavioral_Elements.Common_Behavior.CreateAction)* >

<!ELEMENT Foundation.Core.Classifier.classifierRole
      (Behavioral_Elements.Collaborations.ClassifierRole)* >

<!ELEMENT Foundation.Core.Classifier.collaboration
```

```

                                (Behavioral_Elements.Collaborations.Collaboration)* >
<!ELEMENT Foundation.Core.Classifier.classifierInState
                                (Behavioral_Elements.Activity_Graphs.ClassifierInState)* >
<!ELEMENT Foundation.Core.Classifier.objectFlowState
                                (Behavioral_Elements.Activity_Graphs.ObjectFlowState)* >
<!ELEMENT Foundation.Core.Classifier (Foundation.Core.ModelElement.name?,
                                Foundation.Core.ModelElement.visibility?,
                                Foundation.Core.ModelElement.isSpecification?,
                                Foundation.Core.GeneralizableElement.isRoot?,
                                Foundation.Core.GeneralizableElement.isLeaf?,
                                Foundation.Core.GeneralizableElement.isAbstract?,
                                XMI.extension*,
                                Foundation.Core.ModelElement.namespace?,
                                Foundation.Core.ModelElement.clientDependency*,
                                Foundation.Core.ModelElement.constraint*,
                                Foundation.Core.ModelElement.supplierDependency*,
                                Foundation.Core.ModelElement.presentation*,
                                Foundation.Core.ModelElement.targetFlow*,
                                Foundation.Core.ModelElement.sourceFlow*,
                                Foundation.Core.ModelElement.templateParameter3*,
                                Foundation.Core.ModelElement.binding?,
                                Foundation.Core.ModelElement.comment*,
                                Foundation.Core.ModelElement.elementResidence*,
                                Foundation.Core.ModelElement.templateParameter2*,
                                Foundation.Core.ModelElement.stereotype?,
                                Foundation.Core.ModelElement.behavior*,
                                Foundation.Core.ModelElement.classifierRole*,
                                Foundation.Core.ModelElement.collaboration*,
                                Foundation.Core.ModelElement.partition*,
                                Foundation.Core.ModelElement.elementImport*,
                                Foundation.Core.GeneralizableElement.generalization*,
                                Foundation.Core.GeneralizableElement.specialization*,
                                Foundation.Core.Classifier.participant*,
                                Foundation.Core.Classifier.powertypeRange*,
                                Foundation.Core.Classifier.instance*,
                                Foundation.Core.Classifier.createAction*,
                                Foundation.Core.Classifier.classifierRole*,
                                Foundation.Core.Classifier.collaboration*,
                                Foundation.Core.Classifier.classifierInState*,
                                Foundation.Core.Classifier.objectFlowState*,
                                Foundation.Core.ModelElement.templateParameter*,
                                Foundation.Core.ModelElement.taggedValue*,
                                Foundation.Core.Namespace.ownedElement*,
                                Foundation.Core.Classifier.feature*)?
                                >
<!ATTLIST Foundation.Core.Classifier
                                %XMI.element.att;
                                %XMI.link.att;
>
<!-- _____ -->
<!-- _____ -->
<!-- METAMODEL CLASS: Class -->
<!-- _____ -->

<!ELEMENT Foundation.Core.Class.isActive EMPTY >
<!ATTLIST Foundation.Core.Class.isActive
                                xmi.value ( true | false ) #REQUIRED
>
<!ELEMENT Foundation.Core.Class (Foundation.Core.ModelElement.name?,
                                Foundation.Core.ModelElement.visibility?,
                                Foundation.Core.ModelElement.isSpecification?,
                                Foundation.Core.GeneralizableElement.isRoot?,

```

6 UML XMI DTD Specification

```
Foundation.Core.GeneralizableElement.isLeaf?,
Foundation.Core.GeneralizableElement.isAbstract?,
Foundation.Core.Class.isActive?,
XMI.extension*,
Foundation.Core.ModelElement.namespace?,
Foundation.Core.ModelElement.clientDependency*,
Foundation.Core.ModelElement.constraint*,
Foundation.Core.ModelElement.supplierDependency*,
Foundation.Core.ModelElement.presentation*,
Foundation.Core.ModelElement.targetFlow*,
Foundation.Core.ModelElement.sourceFlow*,
Foundation.Core.ModelElement.templateParameter3*,
Foundation.Core.ModelElement.binding?,
Foundation.Core.ModelElement.comment*,
Foundation.Core.ModelElement.elementResidence*,
Foundation.Core.ModelElement.templateParameter2*,
Foundation.Core.ModelElement.stereotype?,
Foundation.Core.ModelElement.behavior*,
Foundation.Core.ModelElement.classifierRole*,
Foundation.Core.ModelElement.collaboration*,
Foundation.Core.ModelElement.partition*,
Foundation.Core.ModelElement.elementImport*,
Foundation.Core.GeneralizableElement.generalization*,
Foundation.Core.GeneralizableElement.specialization*,
Foundation.Core.Classifier.participant*,
Foundation.Core.Classifier.powerTypeRange*,
Foundation.Core.Classifier.instance*,
Foundation.Core.Classifier.createAction*,
Foundation.Core.Classifier.classifierRole*,
Foundation.Core.Classifier.collaboration*,
Foundation.Core.Classifier.classifierInState*,
Foundation.Core.Classifier.objectFlowState*,
Foundation.Core.ModelElement.templateParameter*,
Foundation.Core.ModelElement.taggedValue*,
Foundation.Core.Namespace.ownedElement*,
Foundation.Core.Classifier.feature*)? >

<!ATTLIST Foundation.Core.Class
    %XMI.element.att;
    %XMI.link.att;
>

<!-- _____ -->
<!-- _____ -->
<!-- METAMODEL CLASS:   DataType _____ -->
<!-- _____ -->

<!ELEMENT Foundation.Core.DataType (Foundation.Core.ModelElement.name?,
    Foundation.Core.ModelElement.visibility?,
    Foundation.Core.ModelElement.isSpecification?,
    Foundation.Core.GeneralizableElement.isRoot?,
    Foundation.Core.GeneralizableElement.isLeaf?,
    Foundation.Core.GeneralizableElement.isAbstract?,
    XMI.extension*,
    Foundation.Core.ModelElement.namespace?,
    Foundation.Core.ModelElement.clientDependency*,
    Foundation.Core.ModelElement.constraint*,
    Foundation.Core.ModelElement.supplierDependency*,
    Foundation.Core.ModelElement.presentation*,
    Foundation.Core.ModelElement.targetFlow*,
    Foundation.Core.ModelElement.sourceFlow*,
    Foundation.Core.ModelElement.templateParameter3*,
    Foundation.Core.ModelElement.binding?,
    Foundation.Core.ModelElement.comment*,
    Foundation.Core.ModelElement.elementResidence*,
    Foundation.Core.ModelElement.templateParameter2*,
    Foundation.Core.ModelElement.stereotype?,
    Foundation.Core.ModelElement.behavior*,
```

```

Foundation.Core.ModelElement.classifierRole*,
Foundation.Core.ModelElement.collaboration*,
Foundation.Core.ModelElement.partition*,
Foundation.Core.ModelElement.elementImport*,
Foundation.Core.GeneralizableElement.generalization*,
Foundation.Core.GeneralizableElement.specialization*,
Foundation.Core.Classifier.participant*,
Foundation.Core.Classifier.powerTypeRange*,
Foundation.Core.Classifier.instance*,
Foundation.Core.Classifier.createAction*,
Foundation.Core.Classifier.classifierRole*,
Foundation.Core.Classifier.collaboration*,
Foundation.Core.Classifier.classifierInState*,
Foundation.Core.Classifier.objectFlowState*,
Foundation.Core.ModelElement.templateParameter*,
Foundation.Core.ModelElement.taggedValue*,
Foundation.Core.Namespace.ownedElement*,
Foundation.Core.Classifier.feature*)?
>
<!ATTLIST Foundation.Core.DataType
    %XMI.element.att;
    %XMI.link.att;
>
<!-- _____ -->
<!-- _____ -->
<!-- METAMODEL CLASS: StructuralFeature -->
<!-- _____ -->

<!ELEMENT Foundation.Core.StructuralFeature.multiplicity
    (Foundation.Data_Types.Multiplicity) >

<!ELEMENT Foundation.Core.StructuralFeature.changeability EMPTY >
<!ATTLIST Foundation.Core.StructuralFeature.changeability
    xmi.value ( changeable | frozen | addOnly ) #REQUIRED
>

<!ELEMENT Foundation.Core.StructuralFeature.targetScope EMPTY >
<!ATTLIST Foundation.Core.StructuralFeature.targetScope
    xmi.value ( classifier | instance ) #REQUIRED
>

<!ELEMENT Foundation.Core.StructuralFeature.type (Foundation.Core.Classifier |
    Foundation.Core.Class |
    Foundation.Core.AssociationClass |
    Foundation.Core.DataType |
    Foundation.Core.Interface |
    Foundation.Core.Component |
    Foundation.Core.Node |
    Behavioral_Elements.Common_Behavior.Signal |
    Behavioral_Elements.Common_Behavior.Exception |
    Behavioral_Elements.Use_Cases.UseCase |
    Behavioral_Elements.Use_Cases.Actor |
    Behavioral_Elements.Collaborations.ClassifierRole |
    Behavioral_Elements.Activity_Graphs.ClassifierInState |
    Model_Management.Subsystem)?
>

<!ELEMENT Foundation.Core.StructuralFeature (Foundation.Core.ModelElement.name?,
    Foundation.Core.ModelElement.visibility?,
    Foundation.Core.ModelElement.isSpecification?,
    Foundation.Core.Feature.ownerScope?,
    Foundation.Core.StructuralFeature.multiplicity?,
    Foundation.Core.StructuralFeature.changeability?,
    Foundation.Core.StructuralFeature.targetScope?,
    XMI.extension*,
    Foundation.Core.ModelElement.namespace?,

```

6 UML XMI DTD Specification

```
Foundation.Core.ModelElement.clientDependency*,
Foundation.Core.ModelElement.constraint*,
Foundation.Core.ModelElement.supplierDependency*,
Foundation.Core.ModelElement.presentation*,
Foundation.Core.ModelElement.targetFlow*,
Foundation.Core.ModelElement.sourceFlow*,
Foundation.Core.ModelElement.templateParameter3*,
Foundation.Core.ModelElement.binding?,
Foundation.Core.ModelElement.comment*,
Foundation.Core.ModelElement.elementResidence*,
Foundation.Core.ModelElement.templateParameter2*,
Foundation.Core.ModelElement.stereotype?,
Foundation.Core.ModelElement.behavior*,
Foundation.Core.ModelElement.classifierRole*,
Foundation.Core.ModelElement.collaboration*,
Foundation.Core.ModelElement.partition*,
Foundation.Core.ModelElement.elementImport*,
Foundation.Core.Feature.owner?,
Foundation.Core.Feature.classifierRole*,
Foundation.Core.StructuralFeature.type?,
Foundation.Core.ModelElement.templateParameter*,
Foundation.Core.ModelElement.taggedValue*)?
>
<!ATTLIST Foundation.Core.StructuralFeature
    %XMI.element.att;
    %XMI.link.att;
>
<!-- _____ -->
<!-- -->
<!-- METAMODEL CLASS: Namespace -->
<!-- _____ -->

<!ELEMENT Foundation.Core.Namespace (Foundation.Core.ModelElement.name?,
Foundation.Core.ModelElement.visibility?,
Foundation.Core.ModelElement.isSpecification?,
XMI.extension*,
Foundation.Core.ModelElement.namespace?,
Foundation.Core.ModelElement.clientDependency*,
Foundation.Core.ModelElement.constraint*,
Foundation.Core.ModelElement.supplierDependency*,
Foundation.Core.ModelElement.presentation*,
Foundation.Core.ModelElement.targetFlow*,
Foundation.Core.ModelElement.sourceFlow*,
Foundation.Core.ModelElement.templateParameter3*,
Foundation.Core.ModelElement.binding?,
Foundation.Core.ModelElement.comment*,
Foundation.Core.ModelElement.elementResidence*,
Foundation.Core.ModelElement.templateParameter2*,
Foundation.Core.ModelElement.stereotype?,
Foundation.Core.ModelElement.behavior*,
Foundation.Core.ModelElement.classifierRole*,
Foundation.Core.ModelElement.collaboration*,
Foundation.Core.ModelElement.partition*,
Foundation.Core.ModelElement.elementImport*,
Foundation.Core.ModelElement.templateParameter*,
Foundation.Core.ModelElement.taggedValue*,
Foundation.Core.Namespace.ownedElement*)?
>
<!ATTLIST Foundation.Core.Namespace
    %XMI.element.att;
    %XMI.link.att;
>
<!-- _____ -->
<!-- -->
<!-- METAMODEL CLASS: AssociationEnd -->
```



```

<!-- ----- -->

<!ELEMENT Foundation.Core.AssociationEnd.isNavigable EMPTY >
<!ATTLIST Foundation.Core.AssociationEnd.isNavigable
    xmi.value ( true | false ) #REQUIRED
>

<!ELEMENT Foundation.Core.AssociationEnd.ordering EMPTY >
<!ATTLIST Foundation.Core.AssociationEnd.ordering
    xmi.value ( unordered | ordered | sorted ) #REQUIRED
>

<!ELEMENT Foundation.Core.AssociationEnd.aggregation EMPTY >
<!ATTLIST Foundation.Core.AssociationEnd.aggregation
    xmi.value ( none | aggregate | composite ) #REQUIRED
>

<!ELEMENT Foundation.Core.AssociationEnd.targetScope EMPTY >
<!ATTLIST Foundation.Core.AssociationEnd.targetScope
    xmi.value ( classifier | instance ) #REQUIRED
>

<!ELEMENT Foundation.Core.AssociationEnd.multiplicity
    (Foundation.Data_Types.Multiplicity) >

<!ELEMENT Foundation.Core.AssociationEnd.changeability EMPTY >
<!ATTLIST Foundation.Core.AssociationEnd.changeability
    xmi.value ( changeable | frozen | addOnly ) #REQUIRED
>

<!ELEMENT Foundation.Core.AssociationEnd.association (Foundation.Core.Association |
    Foundation.Core.AssociationClass |
    Behavioral_Elements.Collaborations.AssociationRole)?
>

<!ELEMENT Foundation.Core.AssociationEnd.type (Foundation.Core.Classifier |
    Foundation.Core.Class |
    Foundation.Core.AssociationClass |
    Foundation.Core.DataType |
    Foundation.Core.Interface |
    Foundation.Core.Component |
    Foundation.Core.Node |
    Behavioral_Elements.Common_Behavior.Signal |
    Behavioral_Elements.Common_Behavior.Exception |
    Behavioral_Elements.Use_Cases.UseCase |
    Behavioral_Elements.Use_Cases.Actor |
    Behavioral_Elements.Collaborations.ClassifierRole |
    Behavioral_Elements.Activity_Graphs.ClassifierInState |
    Model_Management.Subsystem)?
>

<!ELEMENT Foundation.Core.AssociationEnd.specification (Foundation.Core.Classifier |
    Foundation.Core.Class |
    Foundation.Core.AssociationClass |
    Foundation.Core.DataType |
    Foundation.Core.Interface |
    Foundation.Core.Component |
    Foundation.Core.Node |
    Behavioral_Elements.Common_Behavior.Signal |
    Behavioral_Elements.Common_Behavior.Exception |
    Behavioral_Elements.Use_Cases.UseCase |
    Behavioral_Elements.Use_Cases.Actor |
    Behavioral_Elements.Collaborations.ClassifierRole |
    Behavioral_Elements.Activity_Graphs.ClassifierInState |
    Model_Management.Subsystem)*
>

```

6 UML XMI DTD Specification

```
<!ELEMENT Foundation.Core.AssociationEnd.linkEnd
                                (Behavioral_Elements.Common_Behavior.LinkEnd)* >

<!ELEMENT Foundation.Core.AssociationEnd.associationEndRole
                                (Behavioral_Elements.Collaborations.AssociationEndRole)* >

<!ELEMENT Foundation.Core.AssociationEnd (Foundation.Core.ModelElement.name?,
    Foundation.Core.ModelElement.visibility?,
    Foundation.Core.ModelElement.isSpecification?,
    Foundation.Core.AssociationEnd.isNavigable?,
    Foundation.Core.AssociationEnd.ordering?,
    Foundation.Core.AssociationEnd.aggregation?,
    Foundation.Core.AssociationEnd.targetScope?,
    Foundation.Core.AssociationEnd.multiplicity?,
    Foundation.Core.AssociationEnd.changeability?,
    XMI.extension*,
    Foundation.Core.ModelElement.namespace?,
    Foundation.Core.ModelElement.clientDependency*,
    Foundation.Core.ModelElement.constraint*,
    Foundation.Core.ModelElement.supplierDependency*,
    Foundation.Core.ModelElement.presentation*,
    Foundation.Core.ModelElement.targetFlow*,
    Foundation.Core.ModelElement.sourceFlow*,
    Foundation.Core.ModelElement.templateParameter3*,
    Foundation.Core.ModelElement.binding?,
    Foundation.Core.ModelElement.comment*,
    Foundation.Core.ModelElement.elementResidence*,
    Foundation.Core.ModelElement.templateParameter2*,
    Foundation.Core.ModelElement.stereotype?,
    Foundation.Core.ModelElement.behavior*,
    Foundation.Core.ModelElement.classifierRole*,
    Foundation.Core.ModelElement.collaboration*,
    Foundation.Core.ModelElement.partition*,
    Foundation.Core.ModelElement.elementImport*,
    Foundation.Core.AssociationEnd.association?,
    Foundation.Core.AssociationEnd.type?,
    Foundation.Core.AssociationEnd.specification*,
    Foundation.Core.AssociationEnd.linkEnd*,
    Foundation.Core.AssociationEnd.associationEndRole*,
    Foundation.Core.ModelElement.templateParameter*,
    Foundation.Core.ModelElement.taggedValue*,
    Foundation.Core.AssociationEnd.qualified*)?
    >

<!ATTLIST Foundation.Core.AssociationEnd
    %XMI.element.att;
    %XMI.link.att;
>

<!-- _____ -->
<!-- _____ -->
<!-- METAMODEL CLASS: Interface -->
<!-- _____ -->

<!ELEMENT Foundation.Core.Interface (Foundation.Core.ModelElement.name?,
    Foundation.Core.ModelElement.visibility?,
    Foundation.Core.ModelElement.isSpecification?,
    Foundation.Core.GeneralizableElement.isRoot?,
    Foundation.Core.GeneralizableElement.isLeaf?,
    Foundation.Core.GeneralizableElement.isAbstract?,
    XMI.extension*,
    Foundation.Core.ModelElement.namespace?,
    Foundation.Core.ModelElement.clientDependency*,
    Foundation.Core.ModelElement.constraint*,
    Foundation.Core.ModelElement.supplierDependency*,
    Foundation.Core.ModelElement.presentation*,
    Foundation.Core.ModelElement.targetFlow*,
    Foundation.Core.ModelElement.sourceFlow*,
```

```

Foundation.Core.ModelElement.templateParameter3*,
Foundation.Core.ModelElement.binding?,
Foundation.Core.ModelElement.comment*,
Foundation.Core.ModelElement.elementResidence*,
Foundation.Core.ModelElement.templateParameter2*,
Foundation.Core.ModelElement.stereotype?,
Foundation.Core.ModelElement.behavior*,
Foundation.Core.ModelElement.classifierRole*,
Foundation.Core.ModelElement.collaboration*,
Foundation.Core.ModelElement.partition*,
Foundation.Core.ModelElement.elementImport*,
Foundation.Core.GeneralizableElement.generalization*,
Foundation.Core.GeneralizableElement.specialization*,
Foundation.Core.Classifier.participant*,
Foundation.Core.Classifier.powerTypeRange*,
Foundation.Core.Classifier.instance*,
Foundation.Core.Classifier.createAction*,
Foundation.Core.Classifier.classifierRole*,
Foundation.Core.Classifier.collaboration*,
Foundation.Core.Classifier.classifierInState*,
Foundation.Core.Classifier.objectFlowState*,
Foundation.Core.ModelElement.templateParameter*,
Foundation.Core.ModelElement.taggedValue*,
Foundation.Core.Namespace.ownedElement*,
Foundation.Core.Classifier.feature*)?
>

<!-- ATTLIST Foundation.Core.Interface
      %XMI.element.att;
      %XMI.link.att;
-->

<!-- _____ -->
<!-- _____ -->
<!-- METAMODEL CLASS: Constraint _____ -->
<!-- _____ -->

<!-- ELEMENT Foundation.Core.Constraint.body
      (Foundation.Data_Types.BooleanExpression) -->

<!-- ELEMENT Foundation.Core.Constraint.constrainedElement
      (Foundation.Core.ModelElement |
      Foundation.Core.Comment |
      Foundation.Core.Relationship |
      Behavioral_Elements.Use_Cases.Extend |
      Behavioral_Elements.Use_Cases.Include |
      Foundation.Core.Generalization |
      Foundation.Core.Flow |
      Foundation.Core.Association |
      Foundation.Core.AssociationClass |
      Behavioral_Elements.Collaborations.AssociationRole |
      Foundation.Core.Dependency |
      Foundation.Core.Abstraction |
      Foundation.Core.Usage |
      Foundation.Core.Binding |
      Foundation.Core.Permission |
      Foundation.Extension_Mechanisms.TaggedValue |
      Behavioral_Elements.Common_Behavior.Instance |
      Behavioral_Elements.Common_Behavior.Object |
      Behavioral_Elements.Common_Behavior.LinkObject |
      Behavioral_Elements.Common_Behavior.DataValue |
      Behavioral_Elements.Common_Behavior.ComponentInstance |
      Behavioral_Elements.Common_Behavior.NodeInstance |
      Behavioral_Elements.Use_Cases.UseCaseInstance |
      Behavioral_Elements.Common_Behavior.Action |
      Behavioral_Elements.Common_Behavior.CallAction |
      Behavioral_Elements.Common_Behavior.SendAction |
      Behavioral_Elements.Common_Behavior.ActionSequence |
      Behavioral_Elements.Common_Behavior.ReturnAction |

```

6 UML XMI DTD Specification

```
Behavioral_Elements.Common_Behavior.TerminateAction |
Behavioral_Elements.Common_Behavior.DestroyAction |
Behavioral_Elements.Common_Behavior.CreateAction |
Behavioral_Elements.Common_Behavior.UninterpretedAction |
Behavioral_Elements.Common_Behavior.AttributeLink |
Behavioral_Elements.Common_Behavior.Argument |
Behavioral_Elements.Common_Behavior.Link |
Behavioral_Elements.Common_Behavior.LinkEnd |
Behavioral_Elements.Common_Behavior.Stimulus |
Behavioral_Elements.Use_Cases.ExtensionPoint |
Behavioral_Elements.State_Machines.StateMachine |
Behavioral_Elements.Activity_Graphs.ActivityGraph |
Behavioral_Elements.State_Machines.Event |
Behavioral_Elements.State_Machines.TimeEvent |
Behavioral_Elements.State_Machines.CallEvent |
Behavioral_Elements.State_Machines.SignalEvent |
Behavioral_Elements.State_Machines.ChangeEvent |
Behavioral_Elements.State_Machines.Transition |
Behavioral_Elements.State_Machines.StateVertex |
Behavioral_Elements.State_Machines.Pseudostate |
Behavioral_Elements.State_Machines.SynchState |
Behavioral_Elements.State_Machines.StubState |
Behavioral_Elements.State_Machines.State |
Behavioral_Elements.State_Machines.CompositeState |
Behavioral_Elements.State_Machines.SubmachineState |
Behavioral_Elements.Activity_Graphs.SubactivityState |
Behavioral_Elements.State_Machines.SimpleState |
Behavioral_Elements.Activity_Graphs.ObjectFlowState |
Behavioral_Elements.Activity_Graphs.ActionState |
Behavioral_Elements.Activity_Graphs.CallState |
Behavioral_Elements.State_Machines.FinalState |
Behavioral_Elements.State_Machines.Guard |
Behavioral_Elements.Collaborations.Message |
Behavioral_Elements.Collaborations.Interaction |
Behavioral_Elements.Activity_Graphs.Partition |
Foundation.Core.Feature |
Foundation.Core.BehavioralFeature |
Behavioral_Elements.Common_Behavior.Reception |
Foundation.Core.Operation |
Foundation.Core.Method |
Foundation.Core.StructuralFeature |
Foundation.Core.Attribute |
Foundation.Core.GeneralizableElement |
Foundation.Extension_Mechanisms.Stereotype |
Behavioral_Elements.Collaborations.Collaboration |
Model_Management.Package |
Model_Management.Subsystem |
Model_Management.Model |
Foundation.Core.Classifier |
Foundation.Core.Class |
Foundation.Core.DataType |
Foundation.Core.Interface |
Foundation.Core.Component |
Foundation.Core.Node |
Behavioral_Elements.Common_Behavior.Signal |
Behavioral_Elements.Common_Behavior.Exception |
Behavioral_Elements.Use_Cases.UseCase |
Behavioral_Elements.Use_Cases.Actor |
Behavioral_Elements.Collaborations.ClassifierRole |
Behavioral_Elements.Activity_Graphs.ClassifierInState |
Foundation.Core.AssociationEnd |
Behavioral_Elements.Collaborations.AssociationEndRole |
Foundation.Core.Namespace |
Foundation.Core.Parameter |
Foundation.Core.Constraint)*
>
```

<!ELEMENT Foundation.Core.Constraint.constrainedElement2

```

                                (Foundation.Extension_Mechanisms.Stereotype)? >

<!ELEMENT Foundation.Core.Constraint (Foundation.Core.ModelElement.name?,
                                      Foundation.Core.ModelElement.visibility?,
                                      Foundation.Core.ModelElement.isSpecification?,
                                      Foundation.Core.Constraint.body?,
                                      XMI.extension*,
                                      Foundation.Core.ModelElement.namespace?,
                                      Foundation.Core.ModelElement.clientDependency*,
                                      Foundation.Core.ModelElement.constraint*,
                                      Foundation.Core.ModelElement.supplierDependency*,
                                      Foundation.Core.ModelElement.presentation*,
                                      Foundation.Core.ModelElement.targetFlow*,
                                      Foundation.Core.ModelElement.sourceFlow*,
                                      Foundation.Core.ModelElement.templateParameter3*,
                                      Foundation.Core.ModelElement.binding?,
                                      Foundation.Core.ModelElement.comment*,
                                      Foundation.Core.ModelElement.elementResidence*,
                                      Foundation.Core.ModelElement.templateParameter2*,
                                      Foundation.Core.ModelElement.stereotype?,
                                      Foundation.Core.ModelElement.behavior*,
                                      Foundation.Core.ModelElement.classifierRole*,
                                      Foundation.Core.ModelElement.collaboration*,
                                      Foundation.Core.ModelElement.partition*,
                                      Foundation.Core.ModelElement.elementImport*,
                                      Foundation.Core.Constraint.constrainedElement*,
                                      Foundation.Core.Constraint.constrainedElement2?,
                                      Foundation.Core.ModelElement.templateParameter*,
                                      Foundation.Core.ModelElement.taggedValue*)?
                                >

<!ATTLIST Foundation.Core.Constraint
            %XMI.element.att;
            %XMI.link.att;
>

<!-- _____ -->
<!-- _____ -->
<!-- METAMODEL CLASS: Association _____ -->
<!-- _____ -->

<!ELEMENT Foundation.Core.Association.link (Behavioral_Elements.Common_Behavior.Link |
                                             Behavioral_Elements.Common_Behavior.LinkObject)*
                                >

<!ELEMENT Foundation.Core.Association.associationRole
                                (Behavioral_Elements.Collaborations.AssociationRole)* >

<!ELEMENT Foundation.Core.Association (Foundation.Core.ModelElement.name?,
                                      Foundation.Core.ModelElement.visibility?,
                                      Foundation.Core.ModelElement.isSpecification?,
                                      Foundation.Core.GeneralizableElement.isRoot?,
                                      Foundation.Core.GeneralizableElement.isLeaf?,
                                      Foundation.Core.GeneralizableElement.isAbstract?,
                                      XMI.extension*,
                                      Foundation.Core.ModelElement.namespace?,
                                      Foundation.Core.ModelElement.clientDependency*,
                                      Foundation.Core.ModelElement.constraint*,
                                      Foundation.Core.ModelElement.supplierDependency*,
                                      Foundation.Core.ModelElement.presentation*,
                                      Foundation.Core.ModelElement.targetFlow*,
                                      Foundation.Core.ModelElement.sourceFlow*,
                                      Foundation.Core.ModelElement.templateParameter3*,
                                      Foundation.Core.ModelElement.binding?,
                                      Foundation.Core.ModelElement.comment*,
                                      Foundation.Core.ModelElement.elementResidence*,
                                      Foundation.Core.ModelElement.templateParameter2*,
                                      Foundation.Core.ModelElement.stereotype?,

```

6 UML XMI DTD Specification

```
Foundation.Core.ModelElement.behavior*,
Foundation.Core.ModelElement.classifierRole*,
Foundation.Core.ModelElement.collaboration*,
Foundation.Core.ModelElement.partition*,
Foundation.Core.ModelElement.elementImport*,
Foundation.Core.GeneralizableElement.generalization*,
Foundation.Core.GeneralizableElement.specialization*,
Foundation.Core.Association.link*,
Foundation.Core.Association.associationRole*,
Foundation.Core.ModelElement.templateParameter*,
Foundation.Core.ModelElement.taggedValue*,
Foundation.Core.Association.connection*)?
>
<!ATTLIST Foundation.Core.Association
    %XMI.element.att;
    %XMI.link.att;
>

<!-- _____ -->
<!-- _____ -->
<!-- METAMODEL CLASS: Element -->
<!-- _____ -->

<!ELEMENT Foundation.Core.Element (XMI.extension*)? >
<!ATTLIST Foundation.Core.Element
    %XMI.element.att;
    %XMI.link.att;
>

<!-- _____ -->
<!-- _____ -->
<!-- METAMODEL CLASS: GeneralizableElement -->
<!-- _____ -->

<!ELEMENT Foundation.Core.GeneralizableElement.isRoot EMPTY >
<!ATTLIST Foundation.Core.GeneralizableElement.isRoot
    xmi.value ( true | false ) #REQUIRED
>

<!ELEMENT Foundation.Core.GeneralizableElement.isLeaf EMPTY >
<!ATTLIST Foundation.Core.GeneralizableElement.isLeaf
    xmi.value ( true | false ) #REQUIRED
>

<!ELEMENT Foundation.Core.GeneralizableElement.isAbstract EMPTY >
<!ATTLIST Foundation.Core.GeneralizableElement.isAbstract
    xmi.value ( true | false ) #REQUIRED
>

<!ELEMENT Foundation.Core.GeneralizableElement.generalization
    (Foundation.Core.Generalization)* >

<!ELEMENT Foundation.Core.GeneralizableElement.specialization
    (Foundation.Core.Generalization)* >

<!ELEMENT Foundation.Core.GeneralizableElement (Foundation.Core.ModelElement.name?,
    Foundation.Core.ModelElement.visibility?,
    Foundation.Core.ModelElement.isSpecification?,
    Foundation.Core.GeneralizableElement.isRoot?,
    Foundation.Core.GeneralizableElement.isLeaf?,
    Foundation.Core.GeneralizableElement.isAbstract?,
    XMI.extension*,
    Foundation.Core.ModelElement.namespace?,
    Foundation.Core.ModelElement.clientDependency*,
    Foundation.Core.ModelElement.constraint*,
    Foundation.Core.ModelElement.supplierDependency*,
```

```

Foundation.Core.ModelElement.presentation*,
Foundation.Core.ModelElement.targetFlow*,
Foundation.Core.ModelElement.sourceFlow*,
Foundation.Core.ModelElement.templateParameter3*,
Foundation.Core.ModelElement.binding?,
Foundation.Core.ModelElement.comment*,
Foundation.Core.ModelElement.elementResidence*,
Foundation.Core.ModelElement.templateParameter2*,
Foundation.Core.ModelElement.stereotype?,
Foundation.Core.ModelElement.behavior*,
Foundation.Core.ModelElement.classifierRole*,
Foundation.Core.ModelElement.collaboration*,
Foundation.Core.ModelElement.partition*,
Foundation.Core.ModelElement.elementImport*,
Foundation.Core.GeneralizableElement.generalization*,
Foundation.Core.GeneralizableElement.specialization*,
Foundation.Core.ModelElement.templateParameter*,
Foundation.Core.ModelElement.taggedValue*)?
>
<!-- METAMODEL CLASS: Attribute
%XML.element.att;
%XML.link.att;
>
<!-- _____ -->
<!-- _____ -->
<!-- METAMODEL CLASS: Attribute _____ -->
<!-- _____ -->

<!-- ELEMENT Foundation.Core.Attribute.initialValue (Foundation.Data_Types.Expression |
Foundation.Data_Types.BooleanExpression |
Foundation.Data_Types.ActionExpression |
Foundation.Data_Types.IterationExpression |
Foundation.Data_Types.TypeExpression |
Foundation.Data_Types.ArgListsExpression |
Foundation.Data_Types.MappingExpression |
Foundation.Data_Types.ProcedureExpression |
Foundation.Data_Types.TimeExpression |
Foundation.Data_Types.ObjectSetExpression)
>

<!-- ELEMENT Foundation.Core.Attribute.associationEnd (Foundation.Core.AssociationEnd |
Behavioral_Elements.Collaborations.AssociationEndRole)?
>

<!-- ELEMENT Foundation.Core.Attribute.attributeLink
(Behavioral_Elements.Common_Behavior.AttributeLink)* >

<!-- ELEMENT Foundation.Core.Attribute.associationEndRole
(Behavioral_Elements.Collaborations.AssociationEndRole)* >

<!-- ELEMENT Foundation.Core.Attribute (Foundation.Core.ModelElement.name?,
Foundation.Core.ModelElement.visibility?,
Foundation.Core.ModelElement.isSpecification?,
Foundation.Core.Feature.ownerScope?,
Foundation.Core.StructuralFeature.multiplicity?,
Foundation.Core.StructuralFeature.changeability?,
Foundation.Core.StructuralFeature.targetScope?,
Foundation.Core.Attribute.initialValue?,
XMI.extension*,
Foundation.Core.ModelElement.namespace?,
Foundation.Core.ModelElement.clientDependency*,
Foundation.Core.ModelElement.constraint*,
Foundation.Core.ModelElement.supplierDependency*,
Foundation.Core.ModelElement.presentation*,
Foundation.Core.ModelElement.targetFlow*,
Foundation.Core.ModelElement.sourceFlow*,

```

6 UML XMI DTD Specification

```
Foundation.Core.ModelElement.templateParameter3*,
Foundation.Core.ModelElement.binding?,
Foundation.Core.ModelElement.comment*,
Foundation.Core.ModelElement.elementResidence*,
Foundation.Core.ModelElement.templateParameter2*,
Foundation.Core.ModelElement.stereotype?,
Foundation.Core.ModelElement.behavior*,
Foundation.Core.ModelElement.classifierRole*,
Foundation.Core.ModelElement.collaboration*,
Foundation.Core.ModelElement.partition*,
Foundation.Core.ModelElement.elementImport*,
Foundation.Core.Feature.owner?,
Foundation.Core.Feature.classifierRole*,
Foundation.Core.StructuralFeature.type?,
Foundation.Core.Attribute.associationEnd?,
Foundation.Core.Attribute.attributeLink*,
Foundation.Core.Attribute.associationEndRole*,
Foundation.Core.ModelElement.templateParameter*,
Foundation.Core.ModelElement.taggedValue*)?
>

<!ATTLIST Foundation.Core.Attribute
    %XMI.element.att;
    %XMI.link.att;
>

<!-- _____ -->
<!-- _____ -->
<!-- METAMODEL CLASS: Operation _____ -->
<!-- _____ -->

<!ELEMENT Foundation.Core.Operation.concurrency EMPTY >
<!ATTLIST Foundation.Core.Operation.concurrency
    xmi.value ( sequential | guarded | concurrent ) #REQUIRED
>

<!ELEMENT Foundation.Core.Operation.isRoot EMPTY >
<!ATTLIST Foundation.Core.Operation.isRoot
    xmi.value ( true | false ) #REQUIRED
>

<!ELEMENT Foundation.Core.Operation.isLeaf EMPTY >
<!ATTLIST Foundation.Core.Operation.isLeaf
    xmi.value ( true | false ) #REQUIRED
>

<!ELEMENT Foundation.Core.Operation.isAbstract EMPTY >
<!ATTLIST Foundation.Core.Operation.isAbstract
    xmi.value ( true | false ) #REQUIRED
>

<!ELEMENT Foundation.Core.Operation.specification (#PCDATA |
    XMI.reference)* >

<!ELEMENT Foundation.Core.Operation.method (Foundation.Core.Method)* >

<!ELEMENT Foundation.Core.Operation.callAction
    (Behavioral_Elements.Common_Behavior.CallAction)* >

<!ELEMENT Foundation.Core.Operation.occurrence
    (Behavioral_Elements.State_Machines.CallEvent)* >

<!ELEMENT Foundation.Core.Operation.collaboration
    (Behavioral_Elements.Collaborations.Collaboration)* >

<!ELEMENT Foundation.Core.Operation (Foundation.Core.ModelElement.name?,
    Foundation.Core.ModelElement.visibility?,
    Foundation.Core.ModelElement.isSpecification?,
```

6 UML XMI DTD Specification

```
Foundation.Core.Method)?
>

<!ELEMENT Foundation.Core.Parameter.type (Foundation.Core.Classifier |
Foundation.Core.Class |
Foundation.Core.AssociationClass |
Foundation.Core.DataType |
Foundation.Core.Interface |
Foundation.Core.Component |
Foundation.Core.Node |
Behavioral_Elements.Common_Behavior.Signal |
Behavioral_Elements.Common_Behavior.Exception |
Behavioral_Elements.Use_Cases.UseCase |
Behavioral_Elements.Use_Cases.Actor |
Behavioral_Elements.Collaborations.ClassifierRole |
Behavioral_Elements.Activity_Graphs.ClassifierInState |
Model_Management.Subsystem)? >

<!ELEMENT Foundation.Core.Parameter.event (Behavioral_Elements.State_Machines.Event |
Behavioral_Elements.State_Machines.TimeEvent |
Behavioral_Elements.State_Machines.CallEvent |
Behavioral_Elements.State_Machines.SignalEvent |
Behavioral_Elements.State_Machines.ChangeEvent)?
>

<!ELEMENT Foundation.Core.Parameter.state
(Behavioral_Elements.Activity_Graphs.ObjectFlowState)* >

<!ELEMENT Foundation.Core.Parameter (Foundation.Core.ModelElement.name?,
Foundation.Core.ModelElement.visibility?,
Foundation.Core.ModelElement.isSpecification?,
Foundation.Core.Parameter.defaultValue?,
Foundation.Core.Parameter.kind?,
XMI.extension*,
Foundation.Core.ModelElement.namespace?,
Foundation.Core.ModelElement.clientDependency*,
Foundation.Core.ModelElement.constraint*,
Foundation.Core.ModelElement.supplierDependency*,
Foundation.Core.ModelElement.presentation*,
Foundation.Core.ModelElement.targetFlow*,
Foundation.Core.ModelElement.sourceFlow*,
Foundation.Core.ModelElement.templateParameter3*,
Foundation.Core.ModelElement.binding?,
Foundation.Core.ModelElement.comment*,
Foundation.Core.ModelElement.elementResidence*,
Foundation.Core.ModelElement.templateParameter2*,
Foundation.Core.ModelElement.stereotype?,
Foundation.Core.ModelElement.behavior*,
Foundation.Core.ModelElement.classifierRole*,
Foundation.Core.ModelElement.collaboration*,
Foundation.Core.ModelElement.partition*,
Foundation.Core.ModelElement.elementImport*,
Foundation.Core.Parameter.behavioralFeature?,
Foundation.Core.Parameter.type?,
Foundation.Core.Parameter.event?,
Foundation.Core.Parameter.state*,
Foundation.Core.ModelElement.templateParameter*,
Foundation.Core.ModelElement.taggedValue*)?
>

<!ATTLIST Foundation.Core.Parameter
%XMI.element.att;
%XMI.link.att;
>

<!-- _____ -->
<!-- _____ -->
<!-- METAMODEL CLASS: Method -->
<!-- _____ -->
```

```

<!ELEMENT Foundation.Core.Method.body
    (Foundation.Data_Types.ProcedureExpression) >

<!ELEMENT Foundation.Core.Method.specification
    (Foundation.Core.Operation)? >

<!ELEMENT Foundation.Core.Method (Foundation.Core.ModelElement.name?,
    Foundation.Core.ModelElement.visibility?,
    Foundation.Core.ModelElement.isSpecification?,
    Foundation.Core.Feature.ownerScope?,
    Foundation.Core.BehavioralFeature.isQuery?,
    Foundation.Core.Method.body?,
    XMI.extension*,
    Foundation.Core.ModelElement.namespace?,
    Foundation.Core.ModelElement.clientDependency*,
    Foundation.Core.ModelElement.constraint*,
    Foundation.Core.ModelElement.supplierDependency*,
    Foundation.Core.ModelElement.presentation*,
    Foundation.Core.ModelElement.targetFlow*,
    Foundation.Core.ModelElement.sourceFlow*,
    Foundation.Core.ModelElement.templateParameter3*,
    Foundation.Core.ModelElement.binding?,
    Foundation.Core.ModelElement.comment*,
    Foundation.Core.ModelElement.elementResidence*,
    Foundation.Core.ModelElement.templateParameter2*,
    Foundation.Core.ModelElement.stereotype?,
    Foundation.Core.ModelElement.behavior*,
    Foundation.Core.ModelElement.classifierRole*,
    Foundation.Core.ModelElement.collaboration*,
    Foundation.Core.ModelElement.partition*,
    Foundation.Core.ModelElement.elementImport*,
    Foundation.Core.Feature.owner?,
    Foundation.Core.Feature.classifierRole*,
    Foundation.Core.BehavioralFeature.raisedSignal*,
    Foundation.Core.Method.specification?,
    Foundation.Core.ModelElement.templateParameter*,
    Foundation.Core.ModelElement.taggedValue*,
    Foundation.Core.BehavioralFeature.parameter*)?
    >

<!ATTLIST Foundation.Core.Method
    %XMI.element.att;
    %XMI.link.att;
>

<!-- _____ -->
<!-- _____ -->
<!-- METAMODEL CLASS: Generalization _____ -->
<!-- _____ -->

<!ELEMENT Foundation.Core.Generalization.discriminator (#PCDATA |
    XMI.reference)* >

<!ELEMENT Foundation.Core.Generalization.child (Foundation.Core.GeneralizableElement |
    Foundation.Extension_Mechanisms.Stereotype |
    Behavioral_Elements.Collaborations.Collaboration |
    Model_Management.Package |
    Model_Management.Subsystem |
    Model_Management.Model |
    Foundation.Core.Classifier |
    Foundation.Core.Class |
    Foundation.Core.AssociationClass |
    Foundation.Core.DataType |
    Foundation.Core.Interface |
    Foundation.Core.Component |
    Foundation.Core.Node |

```

6 UML XMI DTD Specification

```
Behavioral_Elements.Common_Behavior.Signal |
Behavioral_Elements.Common_Behavior.Exception |
Behavioral_Elements.Use_Cases.UseCase |
Behavioral_Elements.Use_Cases.Actor |
Behavioral_Elements.Collaborations.ClassifierRole |
Behavioral_Elements.Activity_Graphs.ClassifierInState |
Foundation.Core.Association |
Behavioral_Elements.Collaborations.AssociationRole)?
>

<!ELEMENT Foundation.Core.Generalization.parent (Foundation.Core.GeneralizableElement |
Foundation.Extension_Mechanisms.Stereotype |
Behavioral_Elements.Collaborations.Collaboration |
Model_Management.Package |
Model_Management.Subsystem |
Model_Management.Model |
Foundation.Core.Classifier |
Foundation.Core.Class |
Foundation.Core.AssociationClass |
Foundation.Core.DataType |
Foundation.Core.Interface |
Foundation.Core.Component |
Foundation.Core.Node |
Behavioral_Elements.Common_Behavior.Signal |
Behavioral_Elements.Common_Behavior.Exception |
Behavioral_Elements.Use_Cases.UseCase |
Behavioral_Elements.Use_Cases.Actor |
Behavioral_Elements.Collaborations.ClassifierRole |
Behavioral_Elements.Activity_Graphs.ClassifierInState |
Foundation.Core.Association |
Behavioral_Elements.Collaborations.AssociationRole)?
>

<!ELEMENT Foundation.Core.Generalization.powertype (Foundation.Core.Classifier |
Foundation.Core.Class |
Foundation.Core.AssociationClass |
Foundation.Core.DataType |
Foundation.Core.Interface |
Foundation.Core.Component |
Foundation.Core.Node |
Behavioral_Elements.Common_Behavior.Signal |
Behavioral_Elements.Common_Behavior.Exception |
Behavioral_Elements.Use_Cases.UseCase |
Behavioral_Elements.Use_Cases.Actor |
Behavioral_Elements.Collaborations.ClassifierRole |
Behavioral_Elements.Activity_Graphs.ClassifierInState |
Model_Management.Subsystem)?
>

<!ELEMENT Foundation.Core.Generalization (Foundation.Core.ModelElement.name?,
Foundation.Core.ModelElement.visibility?,
Foundation.Core.ModelElement.isSpecification?,
Foundation.Core.Generalization.discriminator?,
XMI.extension*,
Foundation.Core.ModelElement.namespace?,
Foundation.Core.ModelElement.clientDependency*,
Foundation.Core.ModelElement.constraint*,
Foundation.Core.ModelElement.supplierDependency*,
Foundation.Core.ModelElement.presentation*,
Foundation.Core.ModelElement.targetFlow*,
Foundation.Core.ModelElement.sourceFlow*,
Foundation.Core.ModelElement.templateParameter3*,
Foundation.Core.ModelElement.binding?,
Foundation.Core.ModelElement.comment*,
Foundation.Core.ModelElement.elementResidence*,
Foundation.Core.ModelElement.templateParameter2*,
Foundation.Core.ModelElement.stereotype?,
Foundation.Core.ModelElement.behavior*,
```

```

Foundation.Core.ModelElement.classifierRole*,
Foundation.Core.ModelElement.collaboration*,
Foundation.Core.ModelElement.partition*,
Foundation.Core.ModelElement.elementImport*,
Foundation.Core.Generalization.child?,
Foundation.Core.Generalization.parent?,
Foundation.Core.Generalization.powertype?,
Foundation.Core.ModelElement.templateParameter*,
Foundation.Core.ModelElement.taggedValue*)?
>

<!ATTLIST Foundation.Core.Generalization
    %XMI.element.att;
    %XMI.link.att;
>

<!-- _____ -->
<!-- _____ -->
<!-- METAMODEL CLASS: AssociationClass -->
<!-- _____ -->

<!ELEMENT Foundation.Core.AssociationClass (Foundation.Core.ModelElement.name?,
Foundation.Core.ModelElement.visibility?,
Foundation.Core.ModelElement.isSpecification?,
Foundation.Core.GeneralizableElement.isRoot?,
Foundation.Core.GeneralizableElement.isLeaf?,
Foundation.Core.GeneralizableElement.isAbstract?,
Foundation.Core.Class.isActive?,
XMI.extension*,
Foundation.Core.ModelElement.namespace?,
Foundation.Core.ModelElement.clientDependency*,
Foundation.Core.ModelElement.constraint*,
Foundation.Core.ModelElement.supplierDependency*,
Foundation.Core.ModelElement.presentation*,
Foundation.Core.ModelElement.targetFlow*,
Foundation.Core.ModelElement.sourceFlow*,
Foundation.Core.ModelElement.templateParameter3*,
Foundation.Core.ModelElement.binding?,
Foundation.Core.ModelElement.comment*,
Foundation.Core.ModelElement.elementResidence*,
Foundation.Core.ModelElement.templateParameter2*,
Foundation.Core.ModelElement.stereotype?,
Foundation.Core.ModelElement.behavior*,
Foundation.Core.ModelElement.classifierRole*,
Foundation.Core.ModelElement.collaboration*,
Foundation.Core.ModelElement.partition*,
Foundation.Core.ModelElement.elementImport*,
Foundation.Core.GeneralizableElement.generalization*,
Foundation.Core.GeneralizableElement.specialization*,
Foundation.Core.Association.link*,
Foundation.Core.Association.associationRole*,
Foundation.Core.Classifier.participant*,
Foundation.Core.Classifier.powertypeRange*,
Foundation.Core.Classifier.instance*,
Foundation.Core.Classifier.createAction*,
Foundation.Core.Classifier.classifierRole*,
Foundation.Core.Classifier.collaboration*,
Foundation.Core.Classifier.classifierInState*,
Foundation.Core.Classifier.objectFlowState*,
Foundation.Core.ModelElement.templateParameter*,
Foundation.Core.ModelElement.taggedValue*,
Foundation.Core.Association.connection*,
Foundation.Core.Namespace.ownedElement*,
Foundation.Core.Classifier.feature*)?
>

<!ATTLIST Foundation.Core.AssociationClass
    %XMI.element.att;
    %XMI.link.att;

```

6 UML XMI DTD Specification

```
>

<!-- _____ -->
<!-- _____ -->
<!-- METAMODEL CLASS: Feature _____ -->
<!-- _____ -->

<!ELEMENT Foundation.Core.Feature.ownerScope EMPTY >
<ATTLIST Foundation.Core.Feature.ownerScope
    xmi.value ( classifier | instance ) #REQUIRED
>

<!ELEMENT Foundation.Core.Feature.owner (Foundation.Core.Classifier |
    Foundation.Core.Class |
    Foundation.Core.AssociationClass |
    Foundation.Core.DataType |
    Foundation.Core.Interface |
    Foundation.Core.Component |
    Foundation.Core.Node |
    Behavioral_Elements.Common_Behavior.Signal |
    Behavioral_Elements.Common_Behavior.Exception |
    Behavioral_Elements.Use_Cases.UseCase |
    Behavioral_Elements.Use_Cases.Actor |
    Behavioral_Elements.Collaborations.ClassifierRole |
    Behavioral_Elements.Activity_Graphs.ClassifierInState |
    Model_Management.Subsystem)? >

<!ELEMENT Foundation.Core.Feature.classifierRole
    (Behavioral_Elements.Collaborations.ClassifierRole)* >

<!ELEMENT Foundation.Core.Feature (Foundation.Core.ModelElement.name?,
    Foundation.Core.ModelElement.visibility?,
    Foundation.Core.ModelElement.isSpecification?,
    Foundation.Core.Feature.ownerScope?,
    XMI.extension*,
    Foundation.Core.ModelElement.namespace?,
    Foundation.Core.ModelElement.clientDependency*,
    Foundation.Core.ModelElement.constraint*,
    Foundation.Core.ModelElement.supplierDependency*,
    Foundation.Core.ModelElement.presentation*,
    Foundation.Core.ModelElement.targetFlow*,
    Foundation.Core.ModelElement.sourceFlow*,
    Foundation.Core.ModelElement.templateParameter3*,
    Foundation.Core.ModelElement.binding?,
    Foundation.Core.ModelElement.comment*,
    Foundation.Core.ModelElement.elementResidence*,
    Foundation.Core.ModelElement.templateParameter2*,
    Foundation.Core.ModelElement.stereotype?,
    Foundation.Core.ModelElement.behavior*,
    Foundation.Core.ModelElement.classifierRole*,
    Foundation.Core.ModelElement.collaboration*,
    Foundation.Core.ModelElement.partition*,
    Foundation.Core.ModelElement.elementImport*,
    Foundation.Core.Feature.owner?,
    Foundation.Core.Feature.classifierRole*,
    Foundation.Core.ModelElement.templateParameter*,
    Foundation.Core.ModelElement.taggedValue*)?
>

<ATTLIST Foundation.Core.Feature
    %XMI.element.att;
    %XMI.link.att;
>

<!-- _____ -->
<!-- _____ -->
<!-- METAMODEL CLASS: BehavioralFeature _____ -->
<!-- _____ -->
```

```

<!ELEMENT Foundation.Core.BehavioralFeature.isQuery EMPTY >
<!ATTLIST Foundation.Core.BehavioralFeature.isQuery
    xmi.value ( true | false ) #REQUIRED
>

<!ELEMENT Foundation.Core.BehavioralFeature.raisedSignal (Behavioral_Elements.Common_Behavior.Signal |
    Behavioral_Elements.Common_Behavior.Exception)*
>

<!ELEMENT Foundation.Core.BehavioralFeature (Foundation.Core.ModelElement.name?,
    Foundation.Core.ModelElement.visibility?,
    Foundation.Core.ModelElement.isSpecification?,
    Foundation.Core.Feature.ownerScope?,
    Foundation.Core.BehavioralFeature.isQuery?,
    XMI.extension*,
    Foundation.Core.ModelElement.namespace?,
    Foundation.Core.ModelElement.clientDependency*,
    Foundation.Core.ModelElement.constraint*,
    Foundation.Core.ModelElement.supplierDependency*,
    Foundation.Core.ModelElement.presentation*,
    Foundation.Core.ModelElement.targetFlow*,
    Foundation.Core.ModelElement.sourceFlow*,
    Foundation.Core.ModelElement.templateParameter3*,
    Foundation.Core.ModelElement.binding?,
    Foundation.Core.ModelElement.comment*,
    Foundation.Core.ModelElement.elementResidence*,
    Foundation.Core.ModelElement.templateParameter2*,
    Foundation.Core.ModelElement.stereotype?,
    Foundation.Core.ModelElement.behavior*,
    Foundation.Core.ModelElement.classifierRole*,
    Foundation.Core.ModelElement.collaboration*,
    Foundation.Core.ModelElement.partition*,
    Foundation.Core.ModelElement.elementImport*,
    Foundation.Core.Feature.owner?,
    Foundation.Core.Feature.classifierRole*,
    Foundation.Core.BehavioralFeature.raisedSignal*,
    Foundation.Core.ModelElement.templateParameter*,
    Foundation.Core.ModelElement.taggedValue*,
    Foundation.Core.BehavioralFeature.parameter*)?
>

<!ATTLIST Foundation.Core.BehavioralFeature
    %XMI.element.att;
    %XMI.link.att;
>

<!-- _____ -->
<!-- _____ -->
<!-- METAMODEL CLASS: ModelElement _____ -->
<!-- _____ -->

<!ELEMENT Foundation.Core.ModelElement.name (#PCDATA | XMI.reference)* >

<!ELEMENT Foundation.Core.ModelElement.visibility EMPTY >
<!ATTLIST Foundation.Core.ModelElement.visibility
    xmi.value ( public | private | protected ) #REQUIRED
>

<!ELEMENT Foundation.Core.ModelElement.isSpecification EMPTY >
<!ATTLIST Foundation.Core.ModelElement.isSpecification
    xmi.value ( true | false ) #REQUIRED
>

<!ELEMENT Foundation.Core.ModelElement.namespace (Foundation.Core.Namespace |
    Behavioral_Elements.Collaborations.Collaboration |
    Model_Management.Package |

```

6 UML XMI DTD Specification

```
Model_Management.Subsystem |
Model_Management.Model |
Foundation.Core.Classifier |
Foundation.Core.Class |
Foundation.Core.AssociationClass |
Foundation.Core.DataType |
Foundation.Core.Interface |
Foundation.Core.Component |
Foundation.Core.Node |
Behavioral_Elements.Common_Behavior.Signal |
Behavioral_Elements.Common_Behavior.Exception |
Behavioral_Elements.Use_Cases.UseCase |
Behavioral_Elements.Use_Cases.Actor |
Behavioral_Elements.Collaborations.ClassifierRole |
Behavioral_Elements.Activity_Graphs.ClassifierInState)?
>

<!ELEMENT Foundation.Core.ModelElement.clientDependency (Foundation.Core.Dependency |
Foundation.Core.Abstraction |
Foundation.Core.Usage |
Foundation.Core.Binding |
Foundation.Core.Permission)*
>

<!ELEMENT Foundation.Core.ModelElement.constraint
(Foundation.Core.Constraint)* >

<!ELEMENT Foundation.Core.ModelElement.supplierDependency (Foundation.Core.Dependency |
Foundation.Core.Abstraction |
Foundation.Core.Usage |
Foundation.Core.Binding |
Foundation.Core.Permission)*
>

<!ELEMENT Foundation.Core.ModelElement.presentation
(Foundation.Core.PresentationElement)* >

<!ELEMENT Foundation.Core.ModelElement.targetFlow
(Foundation.Core.Flow)* >

<!ELEMENT Foundation.Core.ModelElement.sourceFlow
(Foundation.Core.Flow)* >

<!ELEMENT Foundation.Core.ModelElement.templateParameter3
(Foundation.Core.TemplateParameter)* >

<!ELEMENT Foundation.Core.ModelElement.binding
(Foundation.Core.Binding)? >

<!ELEMENT Foundation.Core.ModelElement.comment
(Foundation.Core.Comment)* >

<!ELEMENT Foundation.Core.ModelElement.elementResidence
(Foundation.Core.ElementResidence)* >

<!ELEMENT Foundation.Core.ModelElement.templateParameter2
(Foundation.Core.TemplateParameter)* >

<!ELEMENT Foundation.Core.ModelElement.stereotype
(Foundation.Extension_Mechanisms.Stereotype)? >

<!ELEMENT Foundation.Core.ModelElement.behavior (Behavioral_Elements.State_Machines.StateMachine |
Behavioral_Elements.Activity_Graphs.ActivityGraph)*
>

<!ELEMENT Foundation.Core.ModelElement.classifierRole
(Behavioral_Elements.Collaborations.ClassifierRole)* >
```



```

<!ELEMENT Foundation.Core.ModelElement.collaboration
                                (Behavioral_Elements.Collaborations.Collaboration)* >

<!ELEMENT Foundation.Core.ModelElement.partition
                                (Behavioral_Elements.Activity_Graphs.Partition)* >

<!ELEMENT Foundation.Core.ModelElement.elementImport
                                (Model_Management.ElementImport)* >

<!ELEMENT Foundation.Core.ModelElement ( Foundation.Core.ModelElement.name?,
                                Foundation.Core.ModelElement.visibility?,
                                Foundation.Core.ModelElement.isSpecification?,
                                XMI.extension*,
                                Foundation.Core.ModelElement.namespace?,
                                Foundation.Core.ModelElement.clientDependency*,
                                Foundation.Core.ModelElement.constraint*,
                                Foundation.Core.ModelElement.supplierDependency*,
                                Foundation.Core.ModelElement.presentation*,
                                Foundation.Core.ModelElement.targetFlow*,
                                Foundation.Core.ModelElement.sourceFlow*,
                                Foundation.Core.ModelElement.templateParameter3*,
                                Foundation.Core.ModelElement.binding?,
                                Foundation.Core.ModelElement.comment*,
                                Foundation.Core.ModelElement.elementResidence*,
                                Foundation.Core.ModelElement.templateParameter2*,
                                Foundation.Core.ModelElement.stereotype?,
                                Foundation.Core.ModelElement.behavior*,
                                Foundation.Core.ModelElement.classifierRole*,
                                Foundation.Core.ModelElement.collaboration*,
                                Foundation.Core.ModelElement.partition*,
                                Foundation.Core.ModelElement.elementImport*,
                                Foundation.Core.ModelElement.templateParameter*,
                                Foundation.Core.ModelElement.taggedValue*)?
                                >

<!ATTLIST Foundation.Core.ModelElement
            %XMI.element.att;
            %XMI.link.att;
>

<!-- _____ -->
<!-- _____ -->
<!-- METAMODEL CLASS:  Dependency -->
<!-- _____ -->

<!ELEMENT Foundation.Core.Dependency.client (Foundation.Core.ModelElement |
                                Foundation.Core.Comment |
                                Foundation.Core.Relationship |
                                Behavioral_Elements.Use_Cases.Extend |
                                Behavioral_Elements.Use_Cases.Include |
                                Foundation.Core.Generalization |
                                Foundation.Core.Flow |
                                Foundation.Core.Association |
                                Foundation.Core.AssociationClass |
                                Behavioral_Elements.Collaborations.AssociationRole |
                                Foundation.Core.Dependency |
                                Foundation.Core.Abstraction |
                                Foundation.Core.Usage |
                                Foundation.Core.Binding |
                                Foundation.Core.Permission |
                                Foundation.Extension_Mechanisms.TaggedValue |
                                Behavioral_Elements.Common_Behavior.Instance |
                                Behavioral_Elements.Common_Behavior.Object |
                                Behavioral_Elements.Common_Behavior.LinkObject |
                                Behavioral_Elements.Common_Behavior.DataValue |
                                Behavioral_Elements.Common_Behavior.ComponentInstance |
                                Behavioral_Elements.Common_Behavior.NodeInstance |
                                Behavioral_Elements.Use_Cases.UseCaseInstance |

```

6 UML XMI DTD Specification

Behavioral_Elements.Common_Behavior.Action |
Behavioral_Elements.Common_Behavior.CallAction |
Behavioral_Elements.Common_Behavior.SendAction |
Behavioral_Elements.Common_Behavior.ActionSequence |
Behavioral_Elements.Common_Behavior.ReturnAction |
Behavioral_Elements.Common_Behavior.TerminateAction |
Behavioral_Elements.Common_Behavior.DestroyAction |
Behavioral_Elements.Common_Behavior.CreateAction |
Behavioral_Elements.Common_Behavior.UninterpretedAction |
Behavioral_Elements.Common_Behavior.AttributeLink |
Behavioral_Elements.Common_Behavior.Argument |
Behavioral_Elements.Common_Behavior.Link |
Behavioral_Elements.Common_Behavior.LinkEnd |
Behavioral_Elements.Common_Behavior.Stimulus |
Behavioral_Elements.Use_Cases.ExtensionPoint |
Behavioral_Elements.State_Machines.StateMachine |
Behavioral_Elements.Activity_Graphs.ActivityGraph |
Behavioral_Elements.State_Machines.Event |
Behavioral_Elements.State_Machines.TimeEvent |
Behavioral_Elements.State_Machines.CallEvent |
Behavioral_Elements.State_Machines.SignalEvent |
Behavioral_Elements.State_Machines.ChangeEvent |
Behavioral_Elements.State_Machines.Transition |
Behavioral_Elements.State_Machines.StateVertex |
Behavioral_Elements.State_Machines.Pseudostate |
Behavioral_Elements.State_Machines.SynchState |
Behavioral_Elements.State_Machines.StubState |
Behavioral_Elements.State_Machines.State |
Behavioral_Elements.State_Machines.CompositeState |
Behavioral_Elements.State_Machines.SubmachineState |
Behavioral_Elements.Activity_Graphs.SubactivityState |
Behavioral_Elements.State_Machines.SimpleState |
Behavioral_Elements.Activity_Graphs.ObjectFlowState |
Behavioral_Elements.Activity_Graphs.ActionState |
Behavioral_Elements.Activity_Graphs.CallState |
Behavioral_Elements.State_Machines.FinalState |
Behavioral_Elements.State_Machines.Guard |
Behavioral_Elements.Collaborations.Message |
Behavioral_Elements.Collaborations.Interaction |
Behavioral_Elements.Activity_Graphs.Partition |
Foundation.Core.Feature |
Foundation.Core.BehavioralFeature |
Behavioral_Elements.Common_Behavior.Reception |
Foundation.Core.Operation |
Foundation.Core.Method |
Foundation.Core.StructuralFeature |
Foundation.Core.Attribute |
Foundation.Core.GeneralizableElement |
Foundation.Extension_Mechanisms.Stereotype |
Behavioral_Elements.Collaborations.Collaboration |
Model_Management.Package |
Model_Management.Subsystem |
Model_Management.Model |
Foundation.Core.Classifier |
Foundation.Core.Class |
Foundation.Core.DataType |
Foundation.Core.Interface |
Foundation.Core.Component |
Foundation.Core.Node |
Behavioral_Elements.Common_Behavior.Signal |
Behavioral_Elements.Common_Behavior.Exception |
Behavioral_Elements.Use_Cases.UseCase |
Behavioral_Elements.Use_Cases.Actor |
Behavioral_Elements.Collaborations.ClassifierRole |
Behavioral_Elements.Activity_Graphs.ClassifierInState |
Foundation.Core.AssociationEnd |
Behavioral_Elements.Collaborations.AssociationEndRole |
Foundation.Core.Namespace |

```

Foundation.Core.Parameter |
Foundation.Core.Constraint)*
>

<!ELEMENT Foundation.Core.Dependency.supplier (Foundation.Core.ModelElement |
Foundation.Core.Comment |
Foundation.Core.Relationship |
Behavioral_Elements.Use_Cases.Extend |
Behavioral_Elements.Use_Cases.Include |
Foundation.Core.Generalization |
Foundation.Core.Flow |
Foundation.Core.Association |
Foundation.Core.AssociationClass |
Behavioral_Elements.Collaborations.AssociationRole |
Foundation.Core.Dependency |
Foundation.Core.Abstraction |
Foundation.Core.Usage |
Foundation.Core.Binding |
Foundation.Core.Permission |
Foundation.Extension_Mechanisms.TaggedValue |
Behavioral_Elements.Common_Behavior.Instance |
Behavioral_Elements.Common_Behavior.Object |
Behavioral_Elements.Common_Behavior.LinkObject |
Behavioral_Elements.Common_Behavior.DataValue |
Behavioral_Elements.Common_Behavior.ComponentInstance |
Behavioral_Elements.Common_Behavior.NodeInstance |
Behavioral_Elements.Use_Cases.UseCaseInstance |
Behavioral_Elements.Common_Behavior.Action |
Behavioral_Elements.Common_Behavior.CallAction |
Behavioral_Elements.Common_Behavior.SendAction |
Behavioral_Elements.Common_Behavior.ActionSequence |
Behavioral_Elements.Common_Behavior.ReturnAction |
Behavioral_Elements.Common_Behavior.TerminateAction |
Behavioral_Elements.Common_Behavior.DestroyAction |
Behavioral_Elements.Common_Behavior.CreateAction |
Behavioral_Elements.Common_Behavior.UninterpretedAction |
Behavioral_Elements.Common_Behavior.AttributeLink |
Behavioral_Elements.Common_Behavior.Argument |
Behavioral_Elements.Common_Behavior.Link |
Behavioral_Elements.Common_Behavior.LinkEnd |
Behavioral_Elements.Common_Behavior.Stimulus |
Behavioral_Elements.Use_Cases.ExtensionPoint |
Behavioral_Elements.State_Machines.StateMachine |
Behavioral_Elements.Activity_Graphs.ActivityGraph |
Behavioral_Elements.State_Machines.Event |
Behavioral_Elements.State_Machines.TimeEvent |
Behavioral_Elements.State_Machines.CallEvent |
Behavioral_Elements.State_Machines.SignalEvent |
Behavioral_Elements.State_Machines.ChangeEvent |
Behavioral_Elements.State_Machines.Transition |
Behavioral_Elements.State_Machines.StateVertex |
Behavioral_Elements.State_Machines.Pseudostate |
Behavioral_Elements.State_Machines.SynchState |
Behavioral_Elements.State_Machines.StubState |
Behavioral_Elements.State_Machines.State |
Behavioral_Elements.State_Machines.CompositeState |
Behavioral_Elements.State_Machines.SubmachineState |
Behavioral_Elements.Activity_Graphs.SubactivityState |
Behavioral_Elements.State_Machines.SimpleState |
Behavioral_Elements.Activity_Graphs.ObjectFlowState |
Behavioral_Elements.Activity_Graphs.ActionState |
Behavioral_Elements.Activity_Graphs.CallState |
Behavioral_Elements.State_Machines.FinalState |
Behavioral_Elements.State_Machines.Guard |
Behavioral_Elements.Collaborations.Message |
Behavioral_Elements.Collaborations.Interaction |
Behavioral_Elements.Activity_Graphs.Partition |
Foundation.Core.Feature |

```

6 UML XMI DTD Specification

```
Foundation.Core.BehavioralFeature |
Behavioral_Elements.Common_Behavior.Reception |
Foundation.Core.Operation |
Foundation.Core.Method |
Foundation.Core.StructuralFeature |
Foundation.Core.Attribute |
Foundation.Core.GeneralizableElement |
Foundation.Extension_Mechanisms.Stereotype |
Behavioral_Elements.Collaborations.Collaboration |
Model_Management.Package |
Model_Management.Subsystem |
Model_Management.Model |
Foundation.Core.Classifier |
Foundation.Core.Class |
Foundation.Core.DataType |
Foundation.Core.Interface |
Foundation.Core.Component |
Foundation.Core.Node |
Behavioral_Elements.Common_Behavior.Signal |
Behavioral_Elements.Common_Behavior.Exception |
Behavioral_Elements.Use_Cases.UseCase |
Behavioral_Elements.Use_Cases.Actor |
Behavioral_Elements.Collaborations.ClassifierRole |
Behavioral_Elements.Activity_Graphs.ClassifierInState |
Foundation.Core.AssociationEnd |
Behavioral_Elements.Collaborations.AssociationEndRole |
Foundation.Core.Namespace |
Foundation.Core.Parameter |
Foundation.Core.Constraint)*
>

<!ELEMENT Foundation.Core.Dependency (Foundation.Core.ModelElement.name?,
Foundation.Core.ModelElement.visibility?,
Foundation.Core.ModelElement.isSpecification?,
XMI.extension*,
Foundation.Core.ModelElement.namespace?,
Foundation.Core.ModelElement.clientDependency*,
Foundation.Core.ModelElement.constraint*,
Foundation.Core.ModelElement.supplierDependency*,
Foundation.Core.ModelElement.presentation*,
Foundation.Core.ModelElement.targetFlow*,
Foundation.Core.ModelElement.sourceFlow*,
Foundation.Core.ModelElement.templateParameter3*,
Foundation.Core.ModelElement.binding?,
Foundation.Core.ModelElement.comment*,
Foundation.Core.ModelElement.elementResidence*,
Foundation.Core.ModelElement.templateParameter2*,
Foundation.Core.ModelElement.stereotype?,
Foundation.Core.ModelElement.behavior*,
Foundation.Core.ModelElement.classifierRole*,
Foundation.Core.ModelElement.collaboration*,
Foundation.Core.ModelElement.partition*,
Foundation.Core.ModelElement.elementImport*,
Foundation.Core.Dependency.client*,
Foundation.Core.Dependency.supplier*,
Foundation.Core.ModelElement.templateParameter*,
Foundation.Core.ModelElement.taggedValue*)?
>

<!ATTLIST Foundation.Core.Dependency
    %XMI.element.att;
    %XMI.link.att;
>

<!-- _____ -->
<!-- _____ -->
<!-- METAMODEL CLASS: Abstraction -->
<!-- _____ -->
```

```

<!ELEMENT Foundation.Core.Abstraction.mapping
      (Foundation.Data_Types.MappingExpression) >

<!ELEMENT Foundation.Core.Abstraction (Foundation.Core.ModelElement.name?,
      Foundation.Core.ModelElement.visibility?,
      Foundation.Core.ModelElement.isSpecification?,
      Foundation.Core.Abstraction.mapping?,
      XMI.extension*,
      Foundation.Core.ModelElement.namespace?,
      Foundation.Core.ModelElement.clientDependency*,
      Foundation.Core.ModelElement.constraint*,
      Foundation.Core.ModelElement.supplierDependency*,
      Foundation.Core.ModelElement.presentation*,
      Foundation.Core.ModelElement.targetFlow*,
      Foundation.Core.ModelElement.sourceFlow*,
      Foundation.Core.ModelElement.templateParameter3*,
      Foundation.Core.ModelElement.binding?,
      Foundation.Core.ModelElement.comment*,
      Foundation.Core.ModelElement.elementResidence*,
      Foundation.Core.ModelElement.templateParameter2*,
      Foundation.Core.ModelElement.stereotype?,
      Foundation.Core.ModelElement.behavior*,
      Foundation.Core.ModelElement.classifierRole*,
      Foundation.Core.ModelElement.collaboration*,
      Foundation.Core.ModelElement.partition*,
      Foundation.Core.ModelElement.elementImport*,
      Foundation.Core.Dependency.client*,
      Foundation.Core.Dependency.supplier*,
      Foundation.Core.ModelElement.templateParameter*,
      Foundation.Core.ModelElement.taggedValue*)?
      >

<!ATTLIST Foundation.Core.Abstraction
      %XMI.element.att;
      %XMI.link.att;
>

<!-- _____ -->
<!-- _____ -->
<!-- METAMODEL CLASS: PresentationElement -->
<!-- _____ -->

<!ELEMENT Foundation.Core.PresentationElement.subject (Foundation.Core.ModelElement |
      Foundation.Core.Comment |
      Foundation.Core.Relationship |
      Behavioral_Elements.Use_Cases.Extend |
      Behavioral_Elements.Use_Cases.Include |
      Foundation.Core.Generalization |
      Foundation.Core.Flow |
      Foundation.Core.Association |
      Foundation.Core.AssociationClass |
      Behavioral_Elements.Collaborations.AssociationRole |
      Foundation.Core.Dependency |
      Foundation.Core.Abstraction |
      Foundation.Core.Usage |
      Foundation.Core.Binding |
      Foundation.Core.Permission |
      Foundation.Extension_Mechanisms.TaggedValue |
      Behavioral_Elements.Common_Behavior.Instance |
      Behavioral_Elements.Common_Behavior.Object |
      Behavioral_Elements.Common_Behavior.LinkObject |
      Behavioral_Elements.Common_Behavior.DataValue |
      Behavioral_Elements.Common_Behavior.ComponentInstance |
      Behavioral_Elements.Common_Behavior.NodeInstance |
      Behavioral_Elements.Use_Cases.UseCaseInstance |
      Behavioral_Elements.Common_Behavior.Action |
      Behavioral_Elements.Common_Behavior.CallAction |

```

6 UML XMI DTD Specification

```
Behavioral_Elements.Common_Behavior.SendAction |
Behavioral_Elements.Common_Behavior.ActionSequence |
Behavioral_Elements.Common_Behavior.ReturnAction |
Behavioral_Elements.Common_Behavior.TerminateAction |
Behavioral_Elements.Common_Behavior.DestroyAction |
Behavioral_Elements.Common_Behavior.CreateAction |
Behavioral_Elements.Common_Behavior.UninterpretedAction |
Behavioral_Elements.Common_Behavior.AttributeLink |
Behavioral_Elements.Common_Behavior.Argument |
Behavioral_Elements.Common_Behavior.Link |
Behavioral_Elements.Common_Behavior.LinkEnd |
Behavioral_Elements.Common_Behavior.Stimulus |
Behavioral_Elements.Use_Cases.ExtensionPoint |
Behavioral_Elements.State_Machines.StateMachine |
Behavioral_Elements.Activity_Graphs.ActivityGraph |
Behavioral_Elements.State_Machines.Event |
Behavioral_Elements.State_Machines.TimeEvent |
Behavioral_Elements.State_Machines.CallEvent |
Behavioral_Elements.State_Machines.SignalEvent |
Behavioral_Elements.State_Machines.ChangeEvent |
Behavioral_Elements.State_Machines.Transition |
Behavioral_Elements.State_Machines.StateVertex |
Behavioral_Elements.State_Machines.Pseudostate |
Behavioral_Elements.State_Machines.SynchState |
Behavioral_Elements.State_Machines.StubState |
Behavioral_Elements.State_Machines.State |
Behavioral_Elements.State_Machines.CompositeState |
Behavioral_Elements.State_Machines.SubmachineState |
Behavioral_Elements.Activity_Graphs.SubactivityState |
Behavioral_Elements.State_Machines.SimpleState |
Behavioral_Elements.Activity_Graphs.ObjectFlowState |
Behavioral_Elements.Activity_Graphs.ActionState |
Behavioral_Elements.Activity_Graphs.CallState |
Behavioral_Elements.State_Machines.FinalState |
Behavioral_Elements.State_Machines.Guard |
Behavioral_Elements.Collaborations.Message |
Behavioral_Elements.Collaborations.Interaction |
Behavioral_Elements.Activity_Graphs.Partition |
Foundation.Core.Feature |
Foundation.Core.BehavioralFeature |
Behavioral_Elements.Common_Behavior.Reception |
Foundation.Core.Operation |
Foundation.Core.Method |
Foundation.Core.StructuralFeature |
Foundation.Core.Attribute |
Foundation.Core.GeneralizableElement |
Foundation.Extension_Mechanisms.Stereotype |
Behavioral_Elements.Collaborations.Collaboration |
Model_Management.Package |
Model_Management.Subsystem |
Model_Management.Model |
Foundation.Core.Classifier |
Foundation.Core.Class |
Foundation.Core.DataType |
Foundation.Core.Interface |
Foundation.Core.Component |
Foundation.Core.Node |
Behavioral_Elements.Common_Behavior.Signal |
Behavioral_Elements.Common_Behavior.Exception |
Behavioral_Elements.Use_Cases.UseCase |
Behavioral_Elements.Use_Cases.Actor |
Behavioral_Elements.Collaborations.ClassifierRole |
Behavioral_Elements.Activity_Graphs.ClassifierInState |
Foundation.Core.AssociationEnd |
Behavioral_Elements.Collaborations.AssociationEndRole |
Foundation.Core.Namespace |
Foundation.Core.Parameter |
Foundation.Core.Constraint)*
```

```

>
<!ELEMENT Foundation.Core.PresentationElement (XMI.extension*,
                                                Foundation.Core.PresentationElement.subject*)?
>
<!ATTLIST Foundation.Core.PresentationElement
    %XMI.element.att;
    %XMI.link.att;
>
<!-- _____ -->
<!-- _____ -->
<!-- METAMODEL CLASS: Usage _____ -->
<!-- _____ -->

<!ELEMENT Foundation.Core.Usage (Foundation.Core.ModelElement.name?,
                                Foundation.Core.ModelElement.visibility?,
                                Foundation.Core.ModelElement.isSpecification?,
                                XMI.extension*,
                                Foundation.Core.ModelElement.namespace?,
                                Foundation.Core.ModelElement.clientDependency*,
                                Foundation.Core.ModelElement.constraint*,
                                Foundation.Core.ModelElement.supplierDependency*,
                                Foundation.Core.ModelElement.presentation*,
                                Foundation.Core.ModelElement.targetFlow*,
                                Foundation.Core.ModelElement.sourceFlow*,
                                Foundation.Core.ModelElement.templateParameter3*,
                                Foundation.Core.ModelElement.binding?,
                                Foundation.Core.ModelElement.comment*,
                                Foundation.Core.ModelElement.elementResidence*,
                                Foundation.Core.ModelElement.templateParameter2*,
                                Foundation.Core.ModelElement.stereotype?,
                                Foundation.Core.ModelElement.behavior*,
                                Foundation.Core.ModelElement.classifierRole*,
                                Foundation.Core.ModelElement.collaboration*,
                                Foundation.Core.ModelElement.partition*,
                                Foundation.Core.ModelElement.elementImport*,
                                Foundation.Core.Dependency.client*,
                                Foundation.Core.Dependency.supplier*,
                                Foundation.Core.ModelElement.templateParameter*,
                                Foundation.Core.ModelElement.taggedValue*)?
>
<!ATTLIST Foundation.Core.Usage
    %XMI.element.att;
    %XMI.link.att;
>
<!-- _____ -->
<!-- _____ -->
<!-- METAMODEL CLASS: Binding _____ -->
<!-- _____ -->

<!ELEMENT Foundation.Core.Binding.argument (Foundation.Core.ModelElement |
                                            Foundation.Core.Comment |
                                            Foundation.Core.Relationship |
                                            Behavioral_Elements.Use_Cases.Extend |
                                            Behavioral_Elements.Use_Cases.Include |
                                            Foundation.Core.Generalization |
                                            Foundation.Core.Flow |
                                            Foundation.Core.Association |
                                            Foundation.Core.AssociationClass |
                                            Behavioral_Elements.Collaborations.AssociationRole |
                                            Foundation.Core.Dependency |
                                            Foundation.Core.Abstraction |
                                            Foundation.Core.Usage |
                                            Foundation.Core.Binding |

```

6 UML XMI DTD Specification

Foundation.Core.Permission |
Foundation.Extension_Mechanisms.TaggedValue |
Behavioral_Elements.Common_Behavior.Instance |
Behavioral_Elements.Common_Behavior.Object |
Behavioral_Elements.Common_Behavior.LinkObject |
Behavioral_Elements.Common_Behavior.DataValue |
Behavioral_Elements.Common_Behavior.ComponentInstance |
Behavioral_Elements.Common_Behavior.NodeInstance |
Behavioral_Elements.Use_Cases.UseCaseInstance |
Behavioral_Elements.Common_Behavior.Action |
Behavioral_Elements.Common_Behavior.CallAction |
Behavioral_Elements.Common_Behavior.SendAction |
Behavioral_Elements.Common_Behavior.ActionSequence |
Behavioral_Elements.Common_Behavior.ReturnAction |
Behavioral_Elements.Common_Behavior.TerminateAction |
Behavioral_Elements.Common_Behavior.DestroyAction |
Behavioral_Elements.Common_Behavior.CreateAction |
Behavioral_Elements.Common_Behavior.UninterpretedAction |
Behavioral_Elements.Common_Behavior.AttributeLink |
Behavioral_Elements.Common_Behavior.Argument |
Behavioral_Elements.Common_Behavior.Link |
Behavioral_Elements.Common_Behavior.LinkEnd |
Behavioral_Elements.Common_Behavior.Stimulus |
Behavioral_Elements.Use_Cases.ExtensionPoint |
Behavioral_Elements.State_Machines.StateMachine |
Behavioral_Elements.Activity_Graphs.ActivityGraph |
Behavioral_Elements.State_Machines.Event |
Behavioral_Elements.State_Machines.TimeEvent |
Behavioral_Elements.State_Machines.CallEvent |
Behavioral_Elements.State_Machines.SignalEvent |
Behavioral_Elements.State_Machines.ChangeEvent |
Behavioral_Elements.State_Machines.Transition |
Behavioral_Elements.State_Machines.StateVertex |
Behavioral_Elements.State_Machines.Pseudostate |
Behavioral_Elements.State_Machines.SynchState |
Behavioral_Elements.State_Machines.StubState |
Behavioral_Elements.State_Machines.State |
Behavioral_Elements.State_Machines.CompositeState |
Behavioral_Elements.State_Machines.SubmachineState |
Behavioral_Elements.Activity_Graphs.SubactivityState |
Behavioral_Elements.State_Machines.SimpleState |
Behavioral_Elements.Activity_Graphs.ObjectFlowState |
Behavioral_Elements.Activity_Graphs.ActionState |
Behavioral_Elements.Activity_Graphs.CallState |
Behavioral_Elements.State_Machines.FinalState |
Behavioral_Elements.State_Machines.Guard |
Behavioral_Elements.Collaborations.Message |
Behavioral_Elements.Collaborations.Interaction |
Behavioral_Elements.Activity_Graphs.Partition |
Foundation.Core.Feature |
Foundation.Core.BehavioralFeature |
Behavioral_Elements.Common_Behavior.Reception |
Foundation.Core.Operation |
Foundation.Core.Method |
Foundation.Core.StructuralFeature |
Foundation.Core.Attribute |
Foundation.Core.GeneralizableElement |
Foundation.Extension_Mechanisms.Stereotype |
Behavioral_Elements.Collaborations.Collaboration |
Model_Management.Package |
Model_Management.Subsystem |
Model_Management.Model |
Foundation.Core.Classifier |
Foundation.Core.Class |
Foundation.Core.DataType |
Foundation.Core.Interface |
Foundation.Core.Component |
Foundation.Core.Node |

```

Behavioral_Elements.Common_Behavior.Signal |
Behavioral_Elements.Common_Behavior.Exception |
Behavioral_Elements.Use_Cases.UseCase |
Behavioral_Elements.Use_Cases.Actor |
Behavioral_Elements.Collaborations.ClassifierRole |
Behavioral_Elements.Activity_Graphs.ClassifierInState |
Foundation.Core.AssociationEnd |
Behavioral_Elements.Collaborations.AssociationEndRole |
Foundation.Core.Namespace |
Foundation.Core.Parameter |
Foundation.Core.Constraint)* >

<!ELEMENT Foundation.Core.Binding (Foundation.Core.ModelElement.name?,
Foundation.Core.ModelElement.visibility?,
Foundation.Core.ModelElement.isSpecification?,
XMI.extension*,
Foundation.Core.ModelElement.namespace?,
Foundation.Core.ModelElement.clientDependency*,
Foundation.Core.ModelElement.constraint*,
Foundation.Core.ModelElement.supplierDependency*,
Foundation.Core.ModelElement.presentation*,
Foundation.Core.ModelElement.targetFlow*,
Foundation.Core.ModelElement.sourceFlow*,
Foundation.Core.ModelElement.templateParameter3*,
Foundation.Core.ModelElement.binding?,
Foundation.Core.ModelElement.comment*,
Foundation.Core.ModelElement.elementResidence*,
Foundation.Core.ModelElement.templateParameter2*,
Foundation.Core.ModelElement.stereotype?,
Foundation.Core.ModelElement.behavior*,
Foundation.Core.ModelElement.classifierRole*,
Foundation.Core.ModelElement.collaboration*,
Foundation.Core.ModelElement.partition*,
Foundation.Core.ModelElement.elementImport*,
Foundation.Core.Dependency.client*,
Foundation.Core.Dependency.supplier*,
Foundation.Core.Binding.argument*,
Foundation.Core.ModelElement.templateParameter*,
Foundation.Core.ModelElement.taggedValue*)?
>

<!ATTLIST Foundation.Core.Binding
    %XMI.element.att;
    %XMI.link.att;
>

<!-- _____ -->
<!-- _____ -->
<!-- METAMODEL CLASS: Component -->
<!-- _____ -->

<!ELEMENT Foundation.Core.Component.deploymentLocation
    (Foundation.Core.Node)* >

<!ELEMENT Foundation.Core.Component.residentElement
    (Foundation.Core.ElementResidence)* >

<!ELEMENT Foundation.Core.Component (Foundation.Core.ModelElement.name?,
Foundation.Core.ModelElement.visibility?,
Foundation.Core.ModelElement.isSpecification?,
Foundation.Core.GeneralizableElement.isRoot?,
Foundation.Core.GeneralizableElement.isLeaf?,
Foundation.Core.GeneralizableElement.isAbstract?,
XMI.extension*,
Foundation.Core.ModelElement.namespace?,
Foundation.Core.ModelElement.clientDependency*,
Foundation.Core.ModelElement.constraint*,
Foundation.Core.ModelElement.supplierDependency*,

```

6 UML XMI DTD Specification

```
Foundation.Core.ModelElement.presentation*,
Foundation.Core.ModelElement.targetFlow*,
Foundation.Core.ModelElement.sourceFlow*,
Foundation.Core.ModelElement.templateParameter3*,
Foundation.Core.ModelElement.binding?,
Foundation.Core.ModelElement.comment*,
Foundation.Core.ModelElement.elementResidence*,
Foundation.Core.ModelElement.templateParameter2*,
Foundation.Core.ModelElement.stereotype?,
Foundation.Core.ModelElement.behavior*,
Foundation.Core.ModelElement.classifierRole*,
Foundation.Core.ModelElement.collaboration*,
Foundation.Core.ModelElement.partition*,
Foundation.Core.ModelElement.elementImport*,
Foundation.Core.GeneralizableElement.generalization*,
Foundation.Core.GeneralizableElement.specialization*,
Foundation.Core.Classifier.participant*,
Foundation.Core.Classifier.powerTypeRange*,
Foundation.Core.Classifier.instance*,
Foundation.Core.Classifier.createAction*,
Foundation.Core.Classifier.classifierRole*,
Foundation.Core.Classifier.collaboration*,
Foundation.Core.Classifier.classifierInState*,
Foundation.Core.Classifier.objectFlowState*,
Foundation.Core.Component.deployLocation*,
Foundation.Core.Component.residentElement*,
Foundation.Core.ModelElement.templateParameter*,
Foundation.Core.ModelElement.taggedValue*,
Foundation.Core.Namespace.ownedElement*,
Foundation.Core.Classifier.feature*)?
>

<!ATTLIST Foundation.Core.Component
    %XMI.element.att;
    %XMI.link.att;
>

<!-- _____ -->
<!-- _____ -->
<!-- METAMODEL CLASS: Node _____ -->
<!-- _____ -->

<!ELEMENT Foundation.Core.Node.resident (Foundation.Core.Component)* >

<!ELEMENT Foundation.Core.Node (Foundation.Core.ModelElement.name?,
    Foundation.Core.ModelElement.visibility?,
    Foundation.Core.ModelElement.isSpecification?,
    Foundation.Core.GeneralizableElement.isRoot?,
    Foundation.Core.GeneralizableElement.isLeaf?,
    Foundation.Core.GeneralizableElement.isAbstract?,
    XMI.extension*,
    Foundation.Core.ModelElement.namespace?,
    Foundation.Core.ModelElement.clientDependency*,
    Foundation.Core.ModelElement.constraint*,
    Foundation.Core.ModelElement.supplierDependency*,
    Foundation.Core.ModelElement.presentation*,
    Foundation.Core.ModelElement.targetFlow*,
    Foundation.Core.ModelElement.sourceFlow*,
    Foundation.Core.ModelElement.templateParameter3*,
    Foundation.Core.ModelElement.binding?,
    Foundation.Core.ModelElement.comment*,
    Foundation.Core.ModelElement.elementResidence*,
    Foundation.Core.ModelElement.templateParameter2*,
    Foundation.Core.ModelElement.stereotype?,
    Foundation.Core.ModelElement.behavior*,
    Foundation.Core.ModelElement.classifierRole*,
    Foundation.Core.ModelElement.collaboration*,
    Foundation.Core.ModelElement.partition*,
```

6 UML XMI DTD Specification

```
Behavioral_Elements.Use_Cases.Extend |
Behavioral_Elements.Use_Cases.Include |
Foundation.Core.Generalization |
Foundation.Core.Flow |
Foundation.Core.Association |
Foundation.Core.AssociationClass |
Behavioral_Elements.Collaborations.AssociationRole |
Foundation.Core.Dependency |
Foundation.Core.Abstraction |
Foundation.Core.Usage |
Foundation.Core.Binding |
Foundation.Core.Permission |
Foundation.Extension_Mechanisms.TaggedValue |
Behavioral_Elements.Common_Behavior.Instance |
Behavioral_Elements.Common_Behavior.Object |
Behavioral_Elements.Common_Behavior.LinkObject |
Behavioral_Elements.Common_Behavior.DataValue |
Behavioral_Elements.Common_Behavior.ComponentInstance |
Behavioral_Elements.Common_Behavior.NodeInstance |
Behavioral_Elements.Use_Cases.UseCaseInstance |
Behavioral_Elements.Common_Behavior.Action |
Behavioral_Elements.Common_Behavior.CallAction |
Behavioral_Elements.Common_Behavior.SendAction |
Behavioral_Elements.Common_Behavior.ActionSequence |
Behavioral_Elements.Common_Behavior.ReturnAction |
Behavioral_Elements.Common_Behavior.TerminateAction |
Behavioral_Elements.Common_Behavior.DestroyAction |
Behavioral_Elements.Common_Behavior.CreateAction |
Behavioral_Elements.Common_Behavior.UninterpretedAction |
Behavioral_Elements.Common_Behavior.AttributeLink |
Behavioral_Elements.Common_Behavior.Argument |
Behavioral_Elements.Common_Behavior.Link |
Behavioral_Elements.Common_Behavior.LinkEnd |
Behavioral_Elements.Common_Behavior.Stimulus |
Behavioral_Elements.Use_Cases.ExtensionPoint |
Behavioral_Elements.State_Machines.StateMachine |
Behavioral_Elements.Activity_Graphs.ActivityGraph |
Behavioral_Elements.State_Machines.Event |
Behavioral_Elements.State_Machines.TimeEvent |
Behavioral_Elements.State_Machines.CallEvent |
Behavioral_Elements.State_Machines.SignalEvent |
Behavioral_Elements.State_Machines.ChangeEvent |
Behavioral_Elements.State_Machines.Transition |
Behavioral_Elements.State_Machines.StateVertex |
Behavioral_Elements.State_Machines.Pseudostate |
Behavioral_Elements.State_Machines.SynchState |
Behavioral_Elements.State_Machines.StubState |
Behavioral_Elements.State_Machines.State |
Behavioral_Elements.State_Machines.CompositeState |
Behavioral_Elements.State_Machines.SubmachineState |
Behavioral_Elements.Activity_Graphs.SubactivityState |
Behavioral_Elements.State_Machines.SimpleState |
Behavioral_Elements.Activity_Graphs.ObjectFlowState |
Behavioral_Elements.Activity_Graphs.ActionState |
Behavioral_Elements.Activity_Graphs.CallState |
Behavioral_Elements.State_Machines.FinalState |
Behavioral_Elements.State_Machines.Guard |
Behavioral_Elements.Collaborations.Message |
Behavioral_Elements.Collaborations.Interaction |
Behavioral_Elements.Activity_Graphs.Partition |
Foundation.Core.Feature |
Foundation.Core.BehavioralFeature |
Behavioral_Elements.Common_Behavior.Reception |
Foundation.Core.Operation |
Foundation.Core.Method |
Foundation.Core.StructuralFeature |
Foundation.Core.Attribute |
Foundation.Core.GeneralizableElement |
```

```

Foundation.Extension_Mechanisms.Stereotype |
Behavioral_Elements.Collaborations.Collaboration |
Model_Management.Package |
Model_Management.Subsystem |
Model_Management.Model |
Foundation.Core.Classifier |
Foundation.Core.Class |
Foundation.Core.DataType |
Foundation.Core.Interface |
Foundation.Core.Component |
Foundation.Core.Node |
Behavioral_Elements.Common_Behavior.Signal |
Behavioral_Elements.Common_Behavior.Exception |
Behavioral_Elements.Use_Cases.UseCase |
Behavioral_Elements.Use_Cases.Actor |
Behavioral_Elements.Collaborations.ClassifierRole |
Behavioral_Elements.Activity_Graphs.ClassifierInState |
Foundation.Core.AssociationEnd |
Behavioral_Elements.Collaborations.AssociationEndRole |
Foundation.Core.Namespace |
Foundation.Core.Parameter |
Foundation.Core.Constraint)*
>

<!ELEMENT Foundation.Core.Comment (Foundation.Core.ModelElement.name?,
Foundation.Core.ModelElement.visibility?,
Foundation.Core.ModelElement.isSpecification?,
XMI.extension*,
Foundation.Core.ModelElement.namespace?,
Foundation.Core.ModelElement.clientDependency*,
Foundation.Core.ModelElement.constraint*,
Foundation.Core.ModelElement.supplierDependency*,
Foundation.Core.ModelElement.presentation*,
Foundation.Core.ModelElement.targetFlow*,
Foundation.Core.ModelElement.sourceFlow*,
Foundation.Core.ModelElement.templateParameter3*,
Foundation.Core.ModelElement.binding?,
Foundation.Core.ModelElement.comment*,
Foundation.Core.ModelElement.elementResidence*,
Foundation.Core.ModelElement.templateParameter2*,
Foundation.Core.ModelElement.stereotype?,
Foundation.Core.ModelElement.behavior*,
Foundation.Core.ModelElement.classifierRole*,
Foundation.Core.ModelElement.collaboration*,
Foundation.Core.ModelElement.partition*,
Foundation.Core.ModelElement.elementImport*,
Foundation.Core.Comment.annotatedElement*,
Foundation.Core.ModelElement.templateParameter*,
Foundation.Core.ModelElement.taggedValue*)?
>

<!ATTLIST Foundation.Core.Comment
    %XMI.element.att;
    %XMI.link.att;
>

<!-- _____ -->
<!-- _____ -->
<!-- METAMODEL CLASS: Flow _____ -->
<!-- _____ -->

<!ELEMENT Foundation.Core.Flow.target (Foundation.Core.ModelElement |
Foundation.Core.Comment |
Foundation.Core.Relationship |
Behavioral_Elements.Use_Cases.Extend |
Behavioral_Elements.Use_Cases.Include |
Foundation.Core.Generalization |
Foundation.Core.Flow |

```

6 UML XMI DTD Specification

```
Foundation.Core.Association |
Foundation.Core.AssociationClass |
Behavioral_Elements.Collaborations.AssociationRole |
Foundation.Core.Dependency |
Foundation.Core.Abstraction |
Foundation.Core.Usage |
Foundation.Core.Binding |
Foundation.Core.Permission |
Foundation.Extension_Mechanisms.TaggedValue |
Behavioral_Elements.Common_Behavior.Instance |
Behavioral_Elements.Common_Behavior.Object |
Behavioral_Elements.Common_Behavior.LinkObject |
Behavioral_Elements.Common_Behavior.DataValue |
Behavioral_Elements.Common_Behavior.ComponentInstance |
Behavioral_Elements.Common_Behavior.NodeInstance |
Behavioral_Elements.Use_Cases.UseCaseInstance |
Behavioral_Elements.Common_Behavior.Action |
Behavioral_Elements.Common_Behavior.CallAction |
Behavioral_Elements.Common_Behavior.SendAction |
Behavioral_Elements.Common_Behavior.ActionSequence |
Behavioral_Elements.Common_Behavior.ReturnAction |
Behavioral_Elements.Common_Behavior.TerminateAction |
Behavioral_Elements.Common_Behavior.DestroyAction |
Behavioral_Elements.Common_Behavior.CreateAction |
Behavioral_Elements.Common_Behavior.UninterpretedAction |
Behavioral_Elements.Common_Behavior.AttributeLink |
Behavioral_Elements.Common_Behavior.Argument |
Behavioral_Elements.Common_Behavior.Link |
Behavioral_Elements.Common_Behavior.LinkEnd |
Behavioral_Elements.Common_Behavior.Stimulus |
Behavioral_Elements.Use_Cases.ExtensionPoint |
Behavioral_Elements.State_Machines.StateMachine |
Behavioral_Elements.Activity_Graphs.ActivityGraph |
Behavioral_Elements.State_Machines.Event |
Behavioral_Elements.State_Machines.TimeEvent |
Behavioral_Elements.State_Machines.CallEvent |
Behavioral_Elements.State_Machines.SignalEvent |
Behavioral_Elements.State_Machines.ChangeEvent |
Behavioral_Elements.State_Machines.Transition |
Behavioral_Elements.State_Machines.StateVertex |
Behavioral_Elements.State_Machines.Pseudostate |
Behavioral_Elements.State_Machines.SynchState |
Behavioral_Elements.State_Machines.StubState |
Behavioral_Elements.State_Machines.State |
Behavioral_Elements.State_Machines.CompositeState |
Behavioral_Elements.State_Machines.SubmachineState |
Behavioral_Elements.Activity_Graphs.SubactivityState |
Behavioral_Elements.State_Machines.SimpleState |
Behavioral_Elements.Activity_Graphs.ObjectFlowState |
Behavioral_Elements.Activity_Graphs.ActionState |
Behavioral_Elements.Activity_Graphs.CallState |
Behavioral_Elements.State_Machines.FinalState |
Behavioral_Elements.State_Machines.Guard |
Behavioral_Elements.Collaborations.Message |
Behavioral_Elements.Collaborations.Interaction |
Behavioral_Elements.Activity_Graphs.Partition |
Foundation.Core.Feature |
Foundation.Core.BehavioralFeature |
Behavioral_Elements.Common_Behavior.Reception |
Foundation.Core.Operation |
Foundation.Core.Method |
Foundation.Core.StructuralFeature |
Foundation.Core.Attribute |
Foundation.Core.GeneralizableElement |
Foundation.Extension_Mechanisms.Stereotype |
Behavioral_Elements.Collaborations.Collaboration |
Model_Management.Package |
Model_Management.Subsystem |
```

```

Model_Management.Model |
Foundation.Core.Classifier |
Foundation.Core.Class |
Foundation.Core.DataType |
Foundation.Core.Interface |
Foundation.Core.Component |
Foundation.Core.Node |
Behavioral_Elements.Common_Behavior.Signal |
Behavioral_Elements.Common_Behavior.Exception |
Behavioral_Elements.Use_Cases.UseCase |
Behavioral_Elements.Use_Cases.Actor |
Behavioral_Elements.Collaborations.ClassifierRole |
Behavioral_Elements.Activity_Graphs.ClassifierInState |
Foundation.Core.AssociationEnd |
Behavioral_Elements.Collaborations.AssociationEndRole |
Foundation.Core.Namespace |
Foundation.Core.Parameter |
Foundation.Core.Constraint)* >

<!ELEMENT Foundation.Core.Flow.source (Foundation.Core.ModelElement |
Foundation.Core.Comment |
Foundation.Core.Relationship |
Behavioral_Elements.Use_Cases.Extend |
Behavioral_Elements.Use_Cases.Include |
Foundation.Core.Generalization |
Foundation.Core.Flow |
Foundation.Core.Association |
Foundation.Core.AssociationClass |
Behavioral_Elements.Collaborations.AssociationRole |
Foundation.Core.Dependency |
Foundation.Core.Abstraction |
Foundation.Core.Usage |
Foundation.Core.Binding |
Foundation.Core.Permission |
Foundation.Extension_Mechanisms.TaggedValue |
Behavioral_Elements.Common_Behavior.Instance |
Behavioral_Elements.Common_Behavior.Object |
Behavioral_Elements.Common_Behavior.LinkObject |
Behavioral_Elements.Common_Behavior.DataValue |
Behavioral_Elements.Common_Behavior.ComponentInstance |
Behavioral_Elements.Common_Behavior.NodeInstance |
Behavioral_Elements.Use_Cases.UseCaseInstance |
Behavioral_Elements.Common_Behavior.Action |
Behavioral_Elements.Common_Behavior.CallAction |
Behavioral_Elements.Common_Behavior.SendAction |
Behavioral_Elements.Common_Behavior.ActionSequence |
Behavioral_Elements.Common_Behavior.ReturnAction |
Behavioral_Elements.Common_Behavior.TerminateAction |
Behavioral_Elements.Common_Behavior.DestroyAction |
Behavioral_Elements.Common_Behavior.CreateAction |
Behavioral_Elements.Common_Behavior.UninterpretedAction |
Behavioral_Elements.Common_Behavior.AttributeLink |
Behavioral_Elements.Common_Behavior.Argument |
Behavioral_Elements.Common_Behavior.Link |
Behavioral_Elements.Common_Behavior.LinkEnd |
Behavioral_Elements.Common_Behavior.Stimulus |
Behavioral_Elements.Use_Cases.ExtensionPoint |
Behavioral_Elements.State_Machines.StateMachine |
Behavioral_Elements.Activity_Graphs.ActivityGraph |
Behavioral_Elements.State_Machines.Event |
Behavioral_Elements.State_Machines.TimeEvent |
Behavioral_Elements.State_Machines.CallEvent |
Behavioral_Elements.State_Machines.SignalEvent |
Behavioral_Elements.State_Machines.ChangeEvent |
Behavioral_Elements.State_Machines.Transition |
Behavioral_Elements.State_Machines.StateVertex |
Behavioral_Elements.State_Machines.Pseudostate |
Behavioral_Elements.State_Machines.SynchState |

```

6 UML XMI DTD Specification

```
Behavioral_Elements.State_Machines.StubState |
Behavioral_Elements.State_Machines.State |
Behavioral_Elements.State_Machines.CompositeState |
Behavioral_Elements.State_Machines.SubmachineState |
Behavioral_Elements.Activity_Graphs.SubactivityState |
Behavioral_Elements.State_Machines.SimpleState |
Behavioral_Elements.Activity_Graphs.ObjectFlowState |
Behavioral_Elements.Activity_Graphs.ActionState |
Behavioral_Elements.Activity_Graphs.CallState |
Behavioral_Elements.State_Machines.FinalState |
Behavioral_Elements.State_Machines.Guard |
Behavioral_Elements.Collaborations.Message |
Behavioral_Elements.Collaborations.Interaction |
Behavioral_Elements.Activity_Graphs.Partition |
Foundation.Core.Feature |
Foundation.Core.BehavioralFeature |
Behavioral_Elements.Common_Behavior.Reception |
Foundation.Core.Operation |
Foundation.Core.Method |
Foundation.Core.StructuralFeature |
Foundation.Core.Attribute |
Foundation.Core.GeneralizableElement |
Foundation.Extension_Mechanisms.Stereotype |
Behavioral_Elements.Collaborations.Collaboration |
Model_Management.Package |
Model_Management.Subsystem |
Model_Management.Model |
Foundation.Core.Classifier |
Foundation.Core.Class |
Foundation.Core.DataType |
Foundation.Core.Interface |
Foundation.Core.Component |
Foundation.Core.Node |
Behavioral_Elements.Common_Behavior.Signal |
Behavioral_Elements.Common_Behavior.Exception |
Behavioral_Elements.Use_Cases.UseCase |
Behavioral_Elements.Use_Cases.Actor |
Behavioral_Elements.Collaborations.ClassifierRole |
Behavioral_Elements.Activity_Graphs.ClassifierInState |
Foundation.Core.AssociationEnd |
Behavioral_Elements.Collaborations.AssociationEndRole |
Foundation.Core.Namespace |
Foundation.Core.Parameter |
Foundation.Core.Constraint)* >
```

```
<!ELEMENT Foundation.Core.Flow (Foundation.Core.ModelElement.name?,
Foundation.Core.ModelElement.visibility?,
Foundation.Core.ModelElement.isSpecification?,
XML.extension*,
Foundation.Core.ModelElement.namespace?,
Foundation.Core.ModelElement.clientDependency*,
Foundation.Core.ModelElement.constraint*,
Foundation.Core.ModelElement.supplierDependency*,
Foundation.Core.ModelElement.presentation*,
Foundation.Core.ModelElement.targetFlow*,
Foundation.Core.ModelElement.sourceFlow*,
Foundation.Core.ModelElement.templateParameter3*,
Foundation.Core.ModelElement.binding?,
Foundation.Core.ModelElement.comment*,
Foundation.Core.ModelElement.elementResidence*,
Foundation.Core.ModelElement.templateParameter2*,
Foundation.Core.ModelElement.stereotype?,
Foundation.Core.ModelElement.behavior*,
Foundation.Core.ModelElement.classifierRole*,
Foundation.Core.ModelElement.collaboration*,
Foundation.Core.ModelElement.partition*,
Foundation.Core.ModelElement.elementImport*,
Foundation.Core.Flow.target*,
```



```
Foundation.Core.Flow.source*,
Foundation.Core.ModelElement.templateParameter*,
Foundation.Core.ModelElement.taggedValue*)?
>
<!ATTLIST Foundation.Core.Flow
    %XMI.element.att;
    %XMI.link.att;
>

<!-- _____ -->
<!-- _____ -->
<!-- METAMODEL CLASS: Relationship -->
<!-- _____ -->

<!ELEMENT Foundation.Core.Relationship (Foundation.Core.ModelElement.name?,
    Foundation.Core.ModelElement.visibility?,
    Foundation.Core.ModelElement.isSpecification?,
    XMI.extension*,
    Foundation.Core.ModelElement.namespace?,
    Foundation.Core.ModelElement.clientDependency*,
    Foundation.Core.ModelElement.constraint*,
    Foundation.Core.ModelElement.supplierDependency*,
    Foundation.Core.ModelElement.presentation*,
    Foundation.Core.ModelElement.targetFlow*,
    Foundation.Core.ModelElement.sourceFlow*,
    Foundation.Core.ModelElement.templateParameter3*,
    Foundation.Core.ModelElement.binding?,
    Foundation.Core.ModelElement.comment*,
    Foundation.Core.ModelElement.elementResidence*,
    Foundation.Core.ModelElement.templateParameter2*,
    Foundation.Core.ModelElement.stereotype?,
    Foundation.Core.ModelElement.behavior*,
    Foundation.Core.ModelElement.classifierRole*,
    Foundation.Core.ModelElement.collaboration*,
    Foundation.Core.ModelElement.partition*,
    Foundation.Core.ModelElement.elementImport*,
    Foundation.Core.ModelElement.templateParameter*,
    Foundation.Core.ModelElement.taggedValue*)?
>

<!ATTLIST Foundation.Core.Relationship
    %XMI.element.att;
    %XMI.link.att;
>

<!-- _____ -->
<!-- _____ -->
<!-- METAMODEL CLASS: ElementResidence -->
<!-- _____ -->

<!ELEMENT Foundation.Core.ElementResidence.visibility EMPTY >
<!ATTLIST Foundation.Core.ElementResidence.visibility
    xmi.value ( public | private | protected ) #REQUIRED
>

<!ELEMENT Foundation.Core.ElementResidence.resident (Foundation.Core.ModelElement |
    Foundation.Core.Comment |
    Foundation.Core.Relationship |
    Behavioral_Elements.Use_Cases.Extend |
    Behavioral_Elements.Use_Cases.Include |
    Foundation.Core.Generalization |
    Foundation.Core.Flow |
    Foundation.Core.Association |
    Foundation.Core.AssociationClass |
    Behavioral_Elements.Collaborations.AssociationRole |
    Foundation.Core.Dependency |
    Foundation.Core.Abstraction |
```

6 UML XMI DTD Specification

```
Foundation.Core.Usage |
Foundation.Core.Binding |
Foundation.Core.Permission |
Foundation.Extension_Mechanisms.TaggedValue |
Behavioral_Elements.Common_Behavior.Instance |
Behavioral_Elements.Common_Behavior.Object |
Behavioral_Elements.Common_Behavior.LinkObject |
Behavioral_Elements.Common_Behavior.DataValue |
Behavioral_Elements.Common_Behavior.ComponentInstance |
Behavioral_Elements.Common_Behavior.NodeInstance |
Behavioral_Elements.Use_Cases.UseCaseInstance |
Behavioral_Elements.Common_Behavior.Action |
Behavioral_Elements.Common_Behavior.CallAction |
Behavioral_Elements.Common_Behavior.SendAction |
Behavioral_Elements.Common_Behavior.ActionSequence |
Behavioral_Elements.Common_Behavior.ReturnAction |
Behavioral_Elements.Common_Behavior.TerminateAction |
Behavioral_Elements.Common_Behavior.DestroyAction |
Behavioral_Elements.Common_Behavior.CreateAction |
Behavioral_Elements.Common_Behavior.UninterpretedAction |
Behavioral_Elements.Common_Behavior.AttributeLink |
Behavioral_Elements.Common_Behavior.Argument |
Behavioral_Elements.Common_Behavior.Link |
Behavioral_Elements.Common_Behavior.LinkEnd |
Behavioral_Elements.Common_Behavior.Stimulus |
Behavioral_Elements.Use_Cases.ExtensionPoint |
Behavioral_Elements.State_Machines.StateMachine |
Behavioral_Elements.Activity_Graphs.ActivityGraph |
Behavioral_Elements.State_Machines.Event |
Behavioral_Elements.State_Machines.TimeEvent |
Behavioral_Elements.State_Machines.CallEvent |
Behavioral_Elements.State_Machines.SignalEvent |
Behavioral_Elements.State_Machines.ChangeEvent |
Behavioral_Elements.State_Machines.Transition |
Behavioral_Elements.State_Machines.StateVertex |
Behavioral_Elements.State_Machines.Pseudostate |
Behavioral_Elements.State_Machines.SynchState |
Behavioral_Elements.State_Machines.StubState |
Behavioral_Elements.State_Machines.State |
Behavioral_Elements.State_Machines.CompositeState |
Behavioral_Elements.State_Machines.SubmachineState |
Behavioral_Elements.Activity_Graphs.SubactivityState |
Behavioral_Elements.State_Machines.SimpleState |
Behavioral_Elements.Activity_Graphs.ObjectFlowState |
Behavioral_Elements.Activity_Graphs.ActionState |
Behavioral_Elements.Activity_Graphs.CallState |
Behavioral_Elements.State_Machines.FinalState |
Behavioral_Elements.State_Machines.Guard |
Behavioral_Elements.Collaborations.Message |
Behavioral_Elements.Collaborations.Interaction |
Behavioral_Elements.Activity_Graphs.Partition |
Foundation.Core.Feature |
Foundation.Core.BehavioralFeature |
Behavioral_Elements.Common_Behavior.Reception |
Foundation.Core.Operation |
Foundation.Core.Method |
Foundation.Core.StructuralFeature |
Foundation.Core.Attribute |
Foundation.Core.GeneralizableElement |
Foundation.Extension_Mechanisms.Stereotype |
Behavioral_Elements.Collaborations.Collaboration |
Model_Management.Package |
Model_Management.Subsystem |
Model_Management.Model |
Foundation.Core.Classifier |
Foundation.Core.Class |
Foundation.Core.DataType |
Foundation.Core.Interface |
```

```

Foundation.Core.Component |
Foundation.Core.Node |
Behavioral_Elements.Common_Behavior.Signal |
Behavioral_Elements.Common_Behavior.Exception |
Behavioral_Elements.Use_Cases.UseCase |
Behavioral_Elements.Use_Cases.Actor |
Behavioral_Elements.Collaborations.ClassifierRole |
Behavioral_Elements.Activity_Graphs.ClassifierInState |
Foundation.Core.AssociationEnd |
Behavioral_Elements.Collaborations.AssociationEndRole |
Foundation.Core.Namespace |
Foundation.Core.Parameter |
Foundation.Core.Constraint)?
>

<!ELEMENT Foundation.Core.ElementResidence.implementationLocation
                                (Foundation.Core.Component)? >

<!ELEMENT Foundation.Core.ElementResidence (Foundation.Core.ElementResidence.visibility?,
XMI.extension*,
Foundation.Core.ElementResidence.resident?,
Foundation.Core.ElementResidence.implementationLocation?)?
>

<!ATTLIST Foundation.Core.ElementResidence
    %XMI.element.att;
    %XMI.link.att;
>

<!-- _____ -->
<!-- _____ -->
<!-- METAMODEL CLASS:  TemplateParameter          -->
<!-- _____ -->

<!ELEMENT Foundation.Core.TemplateParameter.defaultElement (Foundation.Core.ModelElement |
Foundation.Core.Comment |
Foundation.Core.Relationship |
Behavioral_Elements.Use_Cases.Extend |
Behavioral_Elements.Use_Cases.Include |
Foundation.Core.Generalization |
Foundation.Core.Flow |
Foundation.Core.Association |
Foundation.Core.AssociationClass |
Behavioral_Elements.Collaborations.AssociationRole |
Foundation.Core.Dependency |
Foundation.Core.Abstraction |
Foundation.Core.Usage |
Foundation.Core.Binding |
Foundation.Core.Permission |
Foundation.Extension_Mechanisms.TaggedValue |
Behavioral_Elements.Common_Behavior.Instance |
Behavioral_Elements.Common_Behavior.Object |
Behavioral_Elements.Common_Behavior.LinkObject |
Behavioral_Elements.Common_Behavior.DataValue |
Behavioral_Elements.Common_Behavior.ComponentInstance |
Behavioral_Elements.Common_Behavior.NodeInstance |
Behavioral_Elements.Use_Cases.UseCaseInstance |
Behavioral_Elements.Common_Behavior.Action |
Behavioral_Elements.Common_Behavior.CallAction |
Behavioral_Elements.Common_Behavior.SendAction |
Behavioral_Elements.Common_Behavior.ActionSequence |
Behavioral_Elements.Common_Behavior.ReturnAction |
Behavioral_Elements.Common_Behavior.TerminateAction |
Behavioral_Elements.Common_Behavior.DestroyAction |
Behavioral_Elements.Common_Behavior.CreateAction |
Behavioral_Elements.Common_Behavior.UninterpretedAction |
Behavioral_Elements.Common_Behavior.AttributeLink |
Behavioral_Elements.Common_Behavior.Argument |

```

6 UML XMI DTD Specification

```
Behavioral_Elements.Common_Behavior.Link |
Behavioral_Elements.Common_Behavior.LinkEnd |
Behavioral_Elements.Common_Behavior.Stimulus |
Behavioral_Elements.Use_Cases.ExtensionPoint |
Behavioral_Elements.State_Machines.StateMachine |
Behavioral_Elements.Activity_Graphs.ActivityGraph |
Behavioral_Elements.State_Machines.Event |
Behavioral_Elements.State_Machines.TimeEvent |
Behavioral_Elements.State_Machines.CallEvent |
Behavioral_Elements.State_Machines.SignalEvent |
Behavioral_Elements.State_Machines.ChangeEvent |
Behavioral_Elements.State_Machines.Transition |
Behavioral_Elements.State_Machines.StateVertex |
Behavioral_Elements.State_Machines.Pseudostate |
Behavioral_Elements.State_Machines.SynchState |
Behavioral_Elements.State_Machines.StubState |
Behavioral_Elements.State_Machines.State |
Behavioral_Elements.State_Machines.CompositeState |
Behavioral_Elements.State_Machines.SubmachineState |
Behavioral_Elements.Activity_Graphs.SubactivityState |
Behavioral_Elements.State_Machines.SimpleState |
Behavioral_Elements.Activity_Graphs.ObjectFlowState |
Behavioral_Elements.Activity_Graphs.ActionState |
Behavioral_Elements.Activity_Graphs.CallState |
Behavioral_Elements.State_Machines.FinalState |
Behavioral_Elements.State_Machines.Guard |
Behavioral_Elements.Collaborations.Message |
Behavioral_Elements.Collaborations.Interaction |
Behavioral_Elements.Activity_Graphs.Partition |
Foundation.Core.Feature |
Foundation.Core.BehavioralFeature |
Behavioral_Elements.Common_Behavior.Reception |
Foundation.Core.Operation |
Foundation.Core.Method |
Foundation.Core.StructuralFeature |
Foundation.Core.Attribute |
Foundation.Core.GeneralizableElement |
Foundation.Extension_Mechanisms.Stereotype |
Behavioral_Elements.Collaborations.Collaboration |
Model_Management.Package |
Model_Management.Subsystem |
Model_Management.Model |
Foundation.Core.Classifier |
Foundation.Core.Class |
Foundation.Core.DataType |
Foundation.Core.Interface |
Foundation.Core.Component |
Foundation.Core.Node |
Behavioral_Elements.Common_Behavior.Signal |
Behavioral_Elements.Common_Behavior.Exception |
Behavioral_Elements.Use_Cases.UseCase |
Behavioral_Elements.Use_Cases.Actor |
Behavioral_Elements.Collaborations.ClassifierRole |
Behavioral_Elements.Activity_Graphs.ClassifierInState |
Foundation.Core.AssociationEnd |
Behavioral_Elements.Collaborations.AssociationEndRole |
Foundation.Core.Namespace |
Foundation.Core.Parameter |
Foundation.Core.Constraint)?
>
```

```
<!ELEMENT Foundation.Core.TemplateParameter.modelElement (Foundation.Core.ModelElement |
Foundation.Core.Comment |
Foundation.Core.Relationship |
Behavioral_Elements.Use_Cases.Extend |
Behavioral_Elements.Use_Cases.Include |
Foundation.Core.Generalization |
Foundation.Core.Flow |
```

```
Foundation.Core.Association |
Foundation.Core.AssociationClass |
Behavioral_Elements.Collaborations.AssociationRole |
Foundation.Core.Dependency |
Foundation.Core.Abstraction |
Foundation.Core.Usage |
Foundation.Core.Binding |
Foundation.Core.Permission |
Foundation.Extension_Mechanisms.TaggedValue |
Behavioral_Elements.Common_Behavior.Instance |
Behavioral_Elements.Common_Behavior.Object |
Behavioral_Elements.Common_Behavior.LinkObject |
Behavioral_Elements.Common_Behavior.DataValue |
Behavioral_Elements.Common_Behavior.ComponentInstance |
Behavioral_Elements.Common_Behavior.NodeInstance |
Behavioral_Elements.Use_Cases.UseCaseInstance |
Behavioral_Elements.Common_Behavior.Action |
Behavioral_Elements.Common_Behavior.CallAction |
Behavioral_Elements.Common_Behavior.SendAction |
Behavioral_Elements.Common_Behavior.ActionSequence |
Behavioral_Elements.Common_Behavior.ReturnAction |
Behavioral_Elements.Common_Behavior.TerminateAction |
Behavioral_Elements.Common_Behavior.DestroyAction |
Behavioral_Elements.Common_Behavior.CreateAction |
Behavioral_Elements.Common_Behavior.UninterpretedAction |
Behavioral_Elements.Common_Behavior.AttributeLink |
Behavioral_Elements.Common_Behavior.Argument |
Behavioral_Elements.Common_Behavior.Link |
Behavioral_Elements.Common_Behavior.LinkEnd |
Behavioral_Elements.Common_Behavior.Stimulus |
Behavioral_Elements.Use_Cases.ExtensionPoint |
Behavioral_Elements.State_Machines.StateMachine |
Behavioral_Elements.Activity_Graphs.ActivityGraph |
Behavioral_Elements.State_Machines.Event |
Behavioral_Elements.State_Machines.TimeEvent |
Behavioral_Elements.State_Machines.CallEvent |
Behavioral_Elements.State_Machines.SignalEvent |
Behavioral_Elements.State_Machines.ChangeEvent |
Behavioral_Elements.State_Machines.Transition |
Behavioral_Elements.State_Machines.StateVertex |
Behavioral_Elements.State_Machines.Pseudostate |
Behavioral_Elements.State_Machines.SynchState |
Behavioral_Elements.State_Machines.StubState |
Behavioral_Elements.State_Machines.State |
Behavioral_Elements.State_Machines.CompositeState |
Behavioral_Elements.State_Machines.SubmachineState |
Behavioral_Elements.Activity_Graphs.SubactivityState |
Behavioral_Elements.State_Machines.SimpleState |
Behavioral_Elements.Activity_Graphs.ObjectFlowState |
Behavioral_Elements.Activity_Graphs.ActionState |
Behavioral_Elements.Activity_Graphs.CallState |
Behavioral_Elements.State_Machines.FinalState |
Behavioral_Elements.State_Machines.Guard |
Behavioral_Elements.Collaborations.Message |
Behavioral_Elements.Collaborations.Interaction |
Behavioral_Elements.Activity_Graphs.Partition |
Foundation.Core.Feature |
Foundation.Core.BehavioralFeature |
Behavioral_Elements.Common_Behavior.Reception |
Foundation.Core.Operation |
Foundation.Core.Method |
Foundation.Core.StructuralFeature |
Foundation.Core.Attribute |
Foundation.Core.GeneralizableElement |
Foundation.Extension_Mechanisms.Stereotype |
Behavioral_Elements.Collaborations.Collaboration |
Model_Management.Package |
Model_Management.Subsystem |
```

6 UML XMI DTD Specification

```
Model_Management.Model |
Foundation.Core.Classifier |
Foundation.Core.Class |
Foundation.Core.DataType |
Foundation.Core.Interface |
Foundation.Core.Component |
Foundation.Core.Node |
Behavioral_Elements.Common_Behavior.Signal |
Behavioral_Elements.Common_Behavior.Exception |
Behavioral_Elements.Use_Cases.UseCase |
Behavioral_Elements.Use_Cases.Actor |
Behavioral_Elements.Collaborations.ClassifierRole |
Behavioral_Elements.Activity_Graphs.ClassifierInState |
Foundation.Core.AssociationEnd |
Behavioral_Elements.Collaborations.AssociationEndRole |
Foundation.Core.Namespace |
Foundation.Core.Parameter |
Foundation.Core.Constraint)?
>

<!ELEMENT Foundation.Core.TemplateParameter.modelElement2 (Foundation.Core.ModelElement |
Foundation.Core.Comment |
Foundation.Core.Relationship |
Behavioral_Elements.Use_Cases.Extend |
Behavioral_Elements.Use_Cases.Include |
Foundation.Core.Generalization |
Foundation.Core.Flow |
Foundation.Core.Association |
Foundation.Core.AssociationClass |
Behavioral_Elements.Collaborations.AssociationRole |
Foundation.Core.Dependency |
Foundation.Core.Abstraction |
Foundation.Core.Usage |
Foundation.Core.Binding |
Foundation.Core.Permission |
Foundation.Extension_Mechanisms.TaggedValue |
Behavioral_Elements.Common_Behavior.Instance |
Behavioral_Elements.Common_Behavior.Object |
Behavioral_Elements.Common_Behavior.LinkObject |
Behavioral_Elements.Common_Behavior.DataValue |
Behavioral_Elements.Common_Behavior.ComponentInstance |
Behavioral_Elements.Common_Behavior.NodeInstance |
Behavioral_Elements.Use_Cases.UseCaseInstance |
Behavioral_Elements.Common_Behavior.Action |
Behavioral_Elements.Common_Behavior.CallAction |
Behavioral_Elements.Common_Behavior.SendAction |
Behavioral_Elements.Common_Behavior.ActionSequence |
Behavioral_Elements.Common_Behavior.ReturnAction |
Behavioral_Elements.Common_Behavior.TerminateAction |
Behavioral_Elements.Common_Behavior.DestroyAction |
Behavioral_Elements.Common_Behavior.CreateAction |
Behavioral_Elements.Common_Behavior.UninterpretedAction |
Behavioral_Elements.Common_Behavior.AttributeLink |
Behavioral_Elements.Common_Behavior.Argument |
Behavioral_Elements.Common_Behavior.Link |
Behavioral_Elements.Common_Behavior.LinkEnd |
Behavioral_Elements.Common_Behavior.Stimulus |
Behavioral_Elements.Use_Cases.ExtensionPoint |
Behavioral_Elements.State_Machines.StateMachine |
Behavioral_Elements.Activity_Graphs.ActivityGraph |
Behavioral_Elements.State_Machines.Event |
Behavioral_Elements.State_Machines.TimeEvent |
Behavioral_Elements.State_Machines.CallEvent |
Behavioral_Elements.State_Machines.SignalEvent |
Behavioral_Elements.State_Machines.ChangeEvent |
Behavioral_Elements.State_Machines.Transition |
Behavioral_Elements.State_Machines.StateVertex |
Behavioral_Elements.State_Machines.Pseudostate |
```

```

Behavioral_Elements.State_Machines.SynchState |
Behavioral_Elements.State_Machines.StubState |
Behavioral_Elements.State_Machines.State |
Behavioral_Elements.State_Machines.CompositeState |
Behavioral_Elements.State_Machines.SubmachineState |
Behavioral_Elements.Activity_Graphs.SubactivityState |
Behavioral_Elements.State_Machines.SimpleState |
Behavioral_Elements.Activity_Graphs.ObjectFlowState |
Behavioral_Elements.Activity_Graphs.ActionState |
Behavioral_Elements.Activity_Graphs.CallState |
Behavioral_Elements.State_Machines.FinalState |
Behavioral_Elements.State_Machines.Guard |
Behavioral_Elements.Collaborations.Message |
Behavioral_Elements.Collaborations.Interaction |
Behavioral_Elements.Activity_Graphs.Partition |
Foundation.Core.Feature |
Foundation.Core.BehavioralFeature |
Behavioral_Elements.Common_Behavior.Reception |
Foundation.Core.Operation |
Foundation.Core.Method |
Foundation.Core.StructuralFeature |
Foundation.Core.Attribute |
Foundation.Core.GeneralizableElement |
Foundation.Extension_Mechanisms.Stereotype |
Behavioral_Elements.Collaborations.Collaboration |
Model_Management.Package |
Model_Management.Subsystem |
Model_Management.Model |
Foundation.Core.Classifier |
Foundation.Core.Class |
Foundation.Core.DataType |
Foundation.Core.Interface |
Foundation.Core.Component |
Foundation.Core.Node |
Behavioral_Elements.Common_Behavior.Signal |
Behavioral_Elements.Common_Behavior.Exception |
Behavioral_Elements.Use_Cases.UseCase |
Behavioral_Elements.Use_Cases.Actor |
Behavioral_Elements.Collaborations.ClassifierRole |
Behavioral_Elements.Activity_Graphs.ClassifierInState |
Foundation.Core.AssociationEnd |
Behavioral_Elements.Collaborations.AssociationEndRole |
Foundation.Core.Namespace |
Foundation.Core.Parameter |
Foundation.Core.Constraint)?
>

<!ELEMENT Foundation.Core.TemplateParameter (XMI.extension*,
      Foundation.Core.TemplateParameter.defaultElement?,
      Foundation.Core.TemplateParameter.modelElement?,
      Foundation.Core.TemplateParameter.modelElement2?)?
>

<ATTLIST Foundation.Core.TemplateParameter
      %XMI.element.att;
      %XMI.link.att;
>

<!ELEMENT Foundation.Core ((Foundation.Core.Classifier |
      Foundation.Core.Class |
      Foundation.Core.DataType |
      Foundation.Core.StructuralFeature |
      Foundation.Core.Namespace |
      Foundation.Core.AssociationEnd |
      Foundation.Core.Interface |
      Foundation.Core.Constraint |
      Foundation.Core.Association |
      Foundation.Core.Element |
      Foundation.Core.GeneralizableElement |

```

6 UML XMI DTD Specification

```
Foundation.Core.Attribute |
Foundation.Core.Operation |
Foundation.Core.Parameter |
Foundation.Core.Method |
Foundation.Core.Generalization |
Foundation.Core.AssociationClass |
Foundation.Core.Feature |
Foundation.Core.BehavioralFeature |
Foundation.Core.ModelElement |
Foundation.Core.Dependency |
Foundation.Core.Abstraction |
Foundation.Core.PresentationElement |
Foundation.Core.Usage |
Foundation.Core.Binding |
Foundation.Core.Component |
Foundation.Core.Node |
Foundation.Core.Permission |
Foundation.Core.Comment |
Foundation.Core.Flow |
Foundation.Core.Relationship |
Foundation.Core.ElementResidence |
Foundation.Core.TemplateParameter)* >
<!ATTLIST Foundation.Core
    %XMI.element.att;
    %XMI.link.att;
>
<!-- _____ -->
<!-- _____ -->
<!-- METAMODEL PACKAGE: Data_Types _____ -->
<!-- _____ -->

<!ELEMENT Foundation.Data_Types.Multiplicity.range
    (Foundation.Data_Types.MultiplicityRange)* >

<!-- _____ -->
<!-- _____ -->
<!-- METAMODEL CLASS: Multiplicity _____ -->
<!-- _____ -->

<!ELEMENT Foundation.Data_Types.Multiplicity (XMI.extension*,
    Foundation.Data_Types.Multiplicity.range*)?
>
<!ATTLIST Foundation.Data_Types.Multiplicity
    %XMI.element.att;
    %XMI.link.att;
>
<!-- _____ -->
<!-- _____ -->
<!-- METAMODEL CLASS: ObjectSetExpression _____ -->
<!-- _____ -->

<!ELEMENT Foundation.Data_Types.ObjectSetExpression (Foundation.Data_Types.Expression.language?,
    Foundation.Data_Types.Expression.body?,
    XMI.extension*)? >
<!ATTLIST Foundation.Data_Types.ObjectSetExpression
    %XMI.element.att;
    %XMI.link.att;
>
<!-- _____ -->
<!-- _____ -->
<!-- METAMODEL CLASS: TimeExpression _____ -->
<!-- _____ -->
```



```

<!ELEMENT Foundation.Data_Types.TimeExpression (Foundation.Data_Types.Expression.language?,
                                                Foundation.Data_Types.Expression.body?,
                                                XMI.extension*)? >
<ATTLIST Foundation.Data_Types.TimeExpression
    %XMI.element.att;
    %XMI.link.att;
>

<!-- _____ -->
<!-- -->
<!-- METAMODEL CLASS: Expression -->
<!-- _____ -->

<!ELEMENT Foundation.Data_Types.Expression.language (#PCDATA |
                                                    XMI.reference)* >
<!ELEMENT Foundation.Data_Types.Expression.body (#PCDATA |
                                                XMI.reference)* >
<!ELEMENT Foundation.Data_Types.Expression (Foundation.Data_Types.Expression.language?,
                                                Foundation.Data_Types.Expression.body?,
                                                XMI.extension*)? >
<ATTLIST Foundation.Data_Types.Expression
    %XMI.element.att;
    %XMI.link.att;
>

<!-- _____ -->
<!-- -->
<!-- METAMODEL CLASS: BooleanExpression -->
<!-- _____ -->

<!ELEMENT Foundation.Data_Types.BooleanExpression (Foundation.Data_Types.Expression.language?,
                                                    Foundation.Data_Types.Expression.body?,
                                                    XMI.extension*)? >
<ATTLIST Foundation.Data_Types.BooleanExpression
    %XMI.element.att;
    %XMI.link.att;
>

<!-- _____ -->
<!-- -->
<!-- METAMODEL CLASS: ActionExpression -->
<!-- _____ -->

<!ELEMENT Foundation.Data_Types.ActionExpression (Foundation.Data_Types.Expression.language?,
                                                    Foundation.Data_Types.Expression.body?,
                                                    XMI.extension*)? >
<ATTLIST Foundation.Data_Types.ActionExpression
    %XMI.element.att;
    %XMI.link.att;
>

<!-- _____ -->
<!-- -->
<!-- METAMODEL CLASS: MultiplicityRange -->
<!-- _____ -->

<!ELEMENT Foundation.Data_Types.MultiplicityRange.lower (#PCDATA |
                                                         XMI.reference)* >
<!ELEMENT Foundation.Data_Types.MultiplicityRange.upper (#PCDATA |
                                                         XMI.reference)* >

```

6 UML XMI DTD Specification

```

XMI.reference)* >

<!ELEMENT Foundation.Data_Types.MultiplicityRange.multiplicity
(Foundation.Data_Types.Multiplicity)? >

<!ELEMENT Foundation.Data_Types.MultiplicityRange (Foundation.Data_Types.MultiplicityRange.lower?,
Foundation.Data_Types.MultiplicityRange.upper?,
XMI.extension*,
Foundation.Data_Types.MultiplicityRange.multiplicity)?
>

<!ATTLIST Foundation.Data_Types.MultiplicityRange
%XMI.element.att;
%XMI.link.att;
>

<!-- _____ -->
<!-- _____ -->
<!-- METAMODEL CLASS: IterationExpression -->
<!-- _____ -->

<!ELEMENT Foundation.Data_Types.IterationExpression (Foundation.Data_Types.Expression.language?,
Foundation.Data_Types.Expression.body?,
XMI.extension*)? >

<!ATTLIST Foundation.Data_Types.IterationExpression
%XMI.element.att;
%XMI.link.att;
>

<!-- _____ -->
<!-- _____ -->
<!-- METAMODEL CLASS: TypeExpression -->
<!-- _____ -->

<!ELEMENT Foundation.Data_Types.TypeExpression (Foundation.Data_Types.Expression.language?,
Foundation.Data_Types.Expression.body?,
XMI.extension*)? >

<!ATTLIST Foundation.Data_Types.TypeExpression
%XMI.element.att;
%XMI.link.att;
>

<!-- _____ -->
<!-- _____ -->
<!-- METAMODEL CLASS: ArgListsExpression -->
<!-- _____ -->

<!ELEMENT Foundation.Data_Types.ArgListsExpression (Foundation.Data_Types.Expression.language?,
Foundation.Data_Types.Expression.body?,
XMI.extension*)? >

<!ATTLIST Foundation.Data_Types.ArgListsExpression
%XMI.element.att;
%XMI.link.att;
>

<!-- _____ -->
<!-- _____ -->
<!-- METAMODEL CLASS: MappingExpression -->
<!-- _____ -->

<!ELEMENT Foundation.Data_Types.MappingExpression (Foundation.Data_Types.Expression.language?,
Foundation.Data_Types.Expression.body?,
XMI.extension*)? >

<!ATTLIST Foundation.Data_Types.MappingExpression
%XMI.element.att;
```

```

        %XMI.link.att;
    >

<!-- _____ -->
<!-- _____ -->
<!-- METAMODEL CLASS: ProcedureExpression -->
<!-- _____ -->

<!ELEMENT Foundation.Data_Types.ProcedureExpression (Foundation.Data_Types.Expression.language?,
                                                    Foundation.Data_Types.Expression.body?,
                                                    XMI.extension*)? >

<!ATTLIST Foundation.Data_Types.ProcedureExpression
        %XMI.element.att;
        %XMI.link.att;
>

<!ELEMENT Foundation.Data_Types ((Foundation.Data_Types.Multiplicity |
                                Foundation.Data_Types.ObjectSetExpression |
                                Foundation.Data_Types.TimeExpression |
                                Foundation.Data_Types.Expression |
                                Foundation.Data_Types.BooleanExpression |
                                Foundation.Data_Types.ActionExpression |
                                Foundation.Data_Types.MultiplicityRange |
                                Foundation.Data_Types.IterationExpression |
                                Foundation.Data_Types.TypeExpression |
                                Foundation.Data_Types.ArgListsExpression |
                                Foundation.Data_Types.MappingExpression |
                                Foundation.Data_Types.ProcedureExpression)*)
>

<!ATTLIST Foundation.Data_Types
        %XMI.element.att;
        %XMI.link.att;
>

<!-- _____ -->
<!-- _____ -->
<!-- METAMODEL PACKAGE: Extension_Mechanisms -->
<!-- _____ -->

<!ELEMENT Foundation.Extension_Mechanisms.Stereotype.requiredTag
                                                    (Foundation.Extension_Mechanisms.TaggedValue)* >

<!ELEMENT Foundation.Extension_Mechanisms.Stereotype.stereotypeConstraint
                                                    (Foundation.Core.Constraint)* >

<!ELEMENT Foundation.Core.ModelElement.taggedValue
                                                    (Foundation.Extension_Mechanisms.TaggedValue)* >

<!-- _____ -->
<!-- _____ -->
<!-- METAMODEL CLASS: Stereotype -->
<!-- _____ -->

<!ELEMENT Foundation.Extension_Mechanisms.Stereotype.icon (#PCDATA |
                                                    XMI.reference)*
>

<!ELEMENT Foundation.Extension_Mechanisms.Stereotype.baseClass (#PCDATA |
                                                    XMI.reference)*
>

<!ELEMENT Foundation.Extension_Mechanisms.Stereotype.extendedElement (Foundation.Core.ModelElement |
                                                    Foundation.Core.Comment |
                                                    Foundation.Core.Relationship |
                                                    Behavioral_Elements.Use_Cases.Extend |

```

6 UML XMI DTD Specification

```
Behavioral_Elements.Use_Cases.Include |
Foundation.Core.Generalization |
Foundation.Core.Flow |
Foundation.Core.Association |
Foundation.Core.AssociationClass |
Behavioral_Elements.Collaborations.AssociationRole |
Foundation.Core.Dependency |
Foundation.Core.Abstraction |
Foundation.Core.Usage |
Foundation.Core.Binding |
Foundation.Core.Permission |
Foundation.Extension_Mechanisms.TaggedValue |
Behavioral_Elements.Common_Behavior.Instance |
Behavioral_Elements.Common_Behavior.Object |
Behavioral_Elements.Common_Behavior.LinkObject |
Behavioral_Elements.Common_Behavior.DataValue |
Behavioral_Elements.Common_Behavior.ComponentInstance |
Behavioral_Elements.Common_Behavior.NodeInstance |
Behavioral_Elements.Use_Cases.UseCaseInstance |
Behavioral_Elements.Common_Behavior.Action |
Behavioral_Elements.Common_Behavior.CallAction |
Behavioral_Elements.Common_Behavior.SendAction |
Behavioral_Elements.Common_Behavior.ActionSequence |
Behavioral_Elements.Common_Behavior.ReturnAction |
Behavioral_Elements.Common_Behavior.TerminateAction |
Behavioral_Elements.Common_Behavior.DestroyAction |
Behavioral_Elements.Common_Behavior.CreateAction |
Behavioral_Elements.Common_Behavior.UninterpretedAction |
Behavioral_Elements.Common_Behavior.AttributeLink |
Behavioral_Elements.Common_Behavior.Argument |
Behavioral_Elements.Common_Behavior.Link |
Behavioral_Elements.Common_Behavior.LinkEnd |
Behavioral_Elements.Common_Behavior.Stimulus |
Behavioral_Elements.Use_Cases.ExtensionPoint |
Behavioral_Elements.State_Machines.StateMachine |
Behavioral_Elements.Activity_Graphs.ActivityGraph |
Behavioral_Elements.State_Machines.Event |
Behavioral_Elements.State_Machines.TimeEvent |
Behavioral_Elements.State_Machines.CallEvent |
Behavioral_Elements.State_Machines.SignalEvent |
Behavioral_Elements.State_Machines.ChangeEvent |
Behavioral_Elements.State_Machines.Transition |
Behavioral_Elements.State_Machines.StateVertex |
Behavioral_Elements.State_Machines.Pseudostate |
Behavioral_Elements.State_Machines.SynchState |
Behavioral_Elements.State_Machines.StubState |
Behavioral_Elements.State_Machines.State |
Behavioral_Elements.State_Machines.CompositeState |
Behavioral_Elements.State_Machines.SubmachineState |
Behavioral_Elements.Activity_Graphs.SubactivityState |
Behavioral_Elements.State_Machines.SimpleState |
Behavioral_Elements.Activity_Graphs.ObjectFlowState |
Behavioral_Elements.Activity_Graphs.ActionState |
Behavioral_Elements.Activity_Graphs.CallState |
Behavioral_Elements.State_Machines.FinalState |
Behavioral_Elements.State_Machines.Guard |
Behavioral_Elements.Collaborations.Message |
Behavioral_Elements.Collaborations.Interaction |
Behavioral_Elements.Activity_Graphs.Partition |
Foundation.Core.Feature |
Foundation.Core.BehavioralFeature |
Behavioral_Elements.Common_Behavior.Reception |
Foundation.Core.Operation |
Foundation.Core.Method |
Foundation.Core.StructuralFeature |
Foundation.Core.Attribute |
Foundation.Core.GeneralizableElement |
Foundation.Extension_Mechanisms.Stereotype |
```

```

Behavioral_Elements.Collaborations.Collaboration |
Model_Management.Package |
Model_Management.Subsystem |
Model_Management.Model |
Foundation.Core.Classifier |
Foundation.Core.Class |
Foundation.Core.DataType |
Foundation.Core.Interface |
Foundation.Core.Component |
Foundation.Core.Node |
Behavioral_Elements.Common_Behavior.Signal |
Behavioral_Elements.Common_Behavior.Exception |
Behavioral_Elements.Use_Cases.UseCase |
Behavioral_Elements.Use_Cases.Actor |
Behavioral_Elements.Collaborations.ClassifierRole |
Behavioral_Elements.Activity_Graphs.ClassifierInState |
Foundation.Core.AssociationEnd |
Behavioral_Elements.Collaborations.AssociationEndRole |
Foundation.Core.Namespace |
Foundation.Core.Parameter |
Foundation.Core.Constraint)*
>

<!ELEMENT Foundation.Extension_Mechanisms.Stereotype (Foundation.Core.ModelElement.name?,
Foundation.Core.ModelElement.visibility?,
Foundation.Core.ModelElement.isSpecification?,
Foundation.Core.GeneralizableElement.isRoot?,
Foundation.Core.GeneralizableElement.isLeaf?,
Foundation.Core.GeneralizableElement.isAbstract?,
Foundation.Extension_Mechanisms.Stereotype.icon?,
Foundation.Extension_Mechanisms.Stereotype.baseClass?,
XMI.extension*,
Foundation.Core.ModelElement.namespace?,
Foundation.Core.ModelElement.clientDependency*,
Foundation.Core.ModelElement.constraint*,
Foundation.Core.ModelElement.supplierDependency*,
Foundation.Core.ModelElement.presentation*,
Foundation.Core.ModelElement.targetFlow*,
Foundation.Core.ModelElement.sourceFlow*,
Foundation.Core.ModelElement.templateParameter3*,
Foundation.Core.ModelElement.binding?,
Foundation.Core.ModelElement.comment*,
Foundation.Core.ModelElement.elementResidence*,
Foundation.Core.ModelElement.templateParameter2*,
Foundation.Core.ModelElement.stereotype?,
Foundation.Core.ModelElement.behavior*,
Foundation.Core.ModelElement.classifierRole*,
Foundation.Core.ModelElement.collaboration*,
Foundation.Core.ModelElement.partition*,
Foundation.Core.ModelElement.elementImport*,
Foundation.Core.GeneralizableElement.generalization*,
Foundation.Core.GeneralizableElement.specialization*,
Foundation.Extension_Mechanisms.Stereotype.extendedElement*,
Foundation.Core.ModelElement.templateParameter*,
Foundation.Core.ModelElement.taggedValue*,
Foundation.Extension_Mechanisms.Stereotype.requiredTag*,
Foundation.Extension_Mechanisms.Stereotype.stereotypeConstraint*)?
>

<!ATTLIST Foundation.Extension_Mechanisms.Stereotype
    %XMI.element.att;
    %XMI.link.att;
>

<!-- _____ -->
<!-- _____ -->
<!-- METAMODEL CLASS: TaggedValue -->
<!-- _____ -->

```

6 UML XMI DTD Specification

```
<!ELEMENT Foundation.Extension_Mechanisms.TaggedValue.tag (#PCDATA |
XMI.reference)*
>

<!ELEMENT Foundation.Extension_Mechanisms.TaggedValue.value (#PCDATA |
XMI.reference)*
>

<!ELEMENT Foundation.Extension_Mechanisms.TaggedValue.stereotype
( Foundation.Extension_Mechanisms.Stereotype)? >

<!ELEMENT Foundation.Extension_Mechanisms.TaggedValue.modelElement ( Foundation.Core.ModelElement |
Foundation.Core.Comment |
Foundation.Core.Relationship |
Behavioral_Elements.Use_Cases.Extend |
Behavioral_Elements.Use_Cases.Include |
Foundation.Core.Generalization |
Foundation.Core.Flow |
Foundation.Core.Association |
Foundation.Core.AssociationClass |
Behavioral_Elements.Collaborations.AssociationRole |
Foundation.Core.Dependency |
Foundation.Core.Abstraction |
Foundation.Core.Usage |
Foundation.Core.Binding |
Foundation.Core.Permission |
Foundation.Extension_Mechanisms.TaggedValue |
Behavioral_Elements.Common_Behavior.Instance |
Behavioral_Elements.Common_Behavior.Object |
Behavioral_Elements.Common_Behavior.LinkObject |
Behavioral_Elements.Common_Behavior.DataValue |
Behavioral_Elements.Common_Behavior.ComponentInstance |
Behavioral_Elements.Common_Behavior.NodeInstance |
Behavioral_Elements.Use_Cases.UseCaseInstance |
Behavioral_Elements.Common_Behavior.Action |
Behavioral_Elements.Common_Behavior.CallAction |
Behavioral_Elements.Common_Behavior.SendAction |
Behavioral_Elements.Common_Behavior.ActionSequence |
Behavioral_Elements.Common_Behavior.ReturnAction |
Behavioral_Elements.Common_Behavior.TerminateAction |
Behavioral_Elements.Common_Behavior.DestroyAction |
Behavioral_Elements.Common_Behavior.CreateAction |
Behavioral_Elements.Common_Behavior.UninterpretedAction |
Behavioral_Elements.Common_Behavior.AttributeLink |
Behavioral_Elements.Common_Behavior.Argument |
Behavioral_Elements.Common_Behavior.Link |
Behavioral_Elements.Common_Behavior.LinkEnd |
Behavioral_Elements.Common_Behavior.Stimulus |
Behavioral_Elements.Use_Cases.ExtensionPoint |
Behavioral_Elements.State_Machines.StateMachine |
Behavioral_Elements.Activity_Graphs.ActivityGraph |
Behavioral_Elements.State_Machines.Event |
Behavioral_Elements.State_Machines.TimeEvent |
Behavioral_Elements.State_Machines.CallEvent |
Behavioral_Elements.State_Machines.SignalEvent |
Behavioral_Elements.State_Machines.ChangeEvent |
Behavioral_Elements.State_Machines.Transition |
Behavioral_Elements.State_Machines.StateVertex |
Behavioral_Elements.State_Machines.Pseudostate |
Behavioral_Elements.State_Machines.SynchState |
Behavioral_Elements.State_Machines.StubState |
Behavioral_Elements.State_Machines.State |
Behavioral_Elements.State_Machines.CompositeState |
Behavioral_Elements.State_Machines.SubmachineState |
Behavioral_Elements.Activity_Graphs.SubactivityState |
Behavioral_Elements.State_Machines.SimpleState |
Behavioral_Elements.Activity_Graphs.ObjectFlowState |
```

```

Behavioral_Elements.Activity_Graphs.ActionState |
Behavioral_Elements.Activity_Graphs.CallState |
Behavioral_Elements.State_Machines.FinalState |
Behavioral_Elements.State_Machines.Guard |
Behavioral_Elements.Collaborations.Message |
Behavioral_Elements.Collaborations.Interaction |
Behavioral_Elements.Activity_Graphs.Partition |
Foundation.Core.Feature |
Foundation.Core.BehavioralFeature |
Behavioral_Elements.Common_Behavior.Reception |
Foundation.Core.Operation |
Foundation.Core.Method |
Foundation.Core.StructuralFeature |
Foundation.Core.Attribute |
Foundation.Core.GeneralizableElement |
Foundation.Extension_Mechanisms.Stereotype |
Behavioral_Elements.Collaborations.Collaboration |
Model_Management.Package |
Model_Management.Subsystem |
Model_Management.Model |
Foundation.Core.Classifier |
Foundation.Core.Class |
Foundation.Core.DataType |
Foundation.Core.Interface |
Foundation.Core.Component |
Foundation.Core.Node |
Behavioral_Elements.Common_Behavior.Signal |
Behavioral_Elements.Common_Behavior.Exception |
Behavioral_Elements.Use_Cases.UseCase |
Behavioral_Elements.Use_Cases.Actor |
Behavioral_Elements.Collaborations.ClassifierRole |
Behavioral_Elements.Activity_Graphs.ClassifierInState |
Foundation.Core.AssociationEnd |
Behavioral_Elements.Collaborations.AssociationEndRole |
Foundation.Core.Namespace |
Foundation.Core.Parameter |
Foundation.Core.Constraint)?
>

<!ELEMENT Foundation.Extension_Mechanisms.TaggedValue (Foundation.Core.ModelElement.name?,
Foundation.Core.ModelElement.visibility?,
Foundation.Core.ModelElement.isSpecification?,
Foundation.Extension_Mechanisms.TaggedValue.tag?,
Foundation.Extension_Mechanisms.TaggedValue.value?,
XMI.extension*,
Foundation.Core.ModelElement.namespace?,
Foundation.Core.ModelElement.clientDependency*,
Foundation.Core.ModelElement.constraint*,
Foundation.Core.ModelElement.supplierDependency*,
Foundation.Core.ModelElement.presentation*,
Foundation.Core.ModelElement.targetFlow*,
Foundation.Core.ModelElement.sourceFlow*,
Foundation.Core.ModelElement.templateParameter3*,
Foundation.Core.ModelElement.binding?,
Foundation.Core.ModelElement.comment*,
Foundation.Core.ModelElement.elementResidence*,
Foundation.Core.ModelElement.templateParameter2*,
Foundation.Core.ModelElement.stereotype?,
Foundation.Core.ModelElement.behavior*,
Foundation.Core.ModelElement.classifierRole*,
Foundation.Core.ModelElement.collaboration*,
Foundation.Core.ModelElement.partition*,
Foundation.Core.ModelElement.elementImport*,
Foundation.Extension_Mechanisms.TaggedValue.stereotype?,
Foundation.Extension_Mechanisms.TaggedValue.modelElement?,
Foundation.Core.ModelElement.templateParameter*,
Foundation.Core.ModelElement.taggedValue*)?
>

```

6 UML XMI DTD Specification

```
<!ATTLIST Foundation.Extension_Mechanisms.TaggedValue
    %XMI.element.att;
    %XMI.link.att;
>

<!ELEMENT Foundation.Extension_Mechanisms ((Foundation.Extension_Mechanisms.Stereotype |
    Foundation.Extension_Mechanisms.TaggedValue)*)
>

<!ATTLIST Foundation.Extension_Mechanisms
    %XMI.element.att;
    %XMI.link.att;
>

<!ELEMENT Foundation ((Foundation.Core | Foundation.Data_Types |
    Foundation.Extension_Mechanisms)*) >
<!ATTLIST Foundation
    %XMI.element.att;
    %XMI.link.att;
>

<!-- _____ -->
<!-- _____ -->
<!-- METAMODEL PACKAGE: Behavioral_Elements _____ -->
<!-- _____ -->

<!-- _____ -->
<!-- _____ -->
<!-- METAMODEL PACKAGE: Common_Behavior _____ -->
<!-- _____ -->

<!ELEMENT Behavioral_Elements.Common_Behavior.Action.actualArgument
    (Behavioral_Elements.Common_Behavior.Argument)* >

<!ELEMENT Behavioral_Elements.Common_Behavior.Instance.slot
    (Behavioral_Elements.Common_Behavior.AttributeLink)* >

<!ELEMENT Behavioral_Elements.Common_Behavior.Link.connection
    (Behavioral_Elements.Common_Behavior.LinkEnd)* >

<!ELEMENT Behavioral_Elements.Common_Behavior.ActionSequence.action (Behavioral_Elements.Common_Behavior.Action |
    Behavioral_Elements.Common_Behavior.CallAction |
    Behavioral_Elements.Common_Behavior.SendAction |
    Behavioral_Elements.Common_Behavior.ActionSequence |
    Behavioral_Elements.Common_Behavior.ReturnAction |
    Behavioral_Elements.Common_Behavior.TerminateAction |
    Behavioral_Elements.Common_Behavior.DestroyAction |
    Behavioral_Elements.Common_Behavior.CreateAction |
    Behavioral_Elements.Common_Behavior.UninterpretedAction)*
>

<!ELEMENT Behavioral_Elements.Common_Behavior.LinkEnd.qualifiedValue
    (Behavioral_Elements.Common_Behavior.AttributeLink)* >

<!-- _____ -->
<!-- _____ -->
<!-- METAMODEL CLASS: Instance _____ -->
<!-- _____ -->

<!ELEMENT Behavioral_Elements.Common_Behavior.Instance.classifier (Foundation.Core.Classifier |
    Foundation.Core.Class |
    Foundation.Core.AssociationClass |
    Foundation.Core.DataType |
    Foundation.Core.Interface |
    Foundation.Core.Component |
    Foundation.Core.Node |
```



```

Behavioral_Elements.Common_Behavior.Signal |
Behavioral_Elements.Common_Behavior.Exception |
Behavioral_Elements.Use_Cases.UseCase |
Behavioral_Elements.Use_Cases.Actor |
Behavioral_Elements.Collaborations.ClassifierRole |
Behavioral_Elements.Activity_Graphs.ClassifierInState |
Model_Management.Subsystem)*
>

<!ELEMENT Behavioral_Elements.Common_Behavior.Instance.attributeLink
    (Behavioral_Elements.Common_Behavior.AttributeLink)* >

<!ELEMENT Behavioral_Elements.Common_Behavior.Instance.linkEnd
    (Behavioral_Elements.Common_Behavior.LinkEnd)* >

<!ELEMENT Behavioral_Elements.Common_Behavior.Instance.stimulus1
    (Behavioral_Elements.Common_Behavior.Stimulus)* >

<!ELEMENT Behavioral_Elements.Common_Behavior.Instance.stimulus3
    (Behavioral_Elements.Common_Behavior.Stimulus)* >

<!ELEMENT Behavioral_Elements.Common_Behavior.Instance.componentInstance
    (Behavioral_Elements.Common_Behavior.ComponentInstance)? >

<!ELEMENT Behavioral_Elements.Common_Behavior.Instance.stimulus2
    (Behavioral_Elements.Common_Behavior.Stimulus)* >

<!ELEMENT Behavioral_Elements.Common_Behavior.Instance
    (Foundation.Core.ModelElement.name?,
    Foundation.Core.ModelElement.visibility?,
    Foundation.Core.ModelElement.isSpecification?,
    XMI.extension*,
    Foundation.Core.ModelElement.namespace?,
    Foundation.Core.ModelElement.clientDependency*,
    Foundation.Core.ModelElement.constraint*,
    Foundation.Core.ModelElement.supplierDependency*,
    Foundation.Core.ModelElement.presentation*,
    Foundation.Core.ModelElement.targetFlow*,
    Foundation.Core.ModelElement.sourceFlow*,
    Foundation.Core.ModelElement.templateParameter3*,
    Foundation.Core.ModelElement.binding?,
    Foundation.Core.ModelElement.comment*,
    Foundation.Core.ModelElement.elementResidence*,
    Foundation.Core.ModelElement.templateParameter2*,
    Foundation.Core.ModelElement.stereotype?,
    Foundation.Core.ModelElement.behavior*,
    Foundation.Core.ModelElement.classifierRole*,
    Foundation.Core.ModelElement.collaboration*,
    Foundation.Core.ModelElement.partition*,
    Foundation.Core.ModelElement.elementImport*,
    Behavioral_Elements.Common_Behavior.Instance.classifier*,
    Behavioral_Elements.Common_Behavior.Instance.attributeLink*,
    Behavioral_Elements.Common_Behavior.Instance.linkEnd*,
    Behavioral_Elements.Common_Behavior.Instance.stimulus1*,
    Behavioral_Elements.Common_Behavior.Instance.stimulus3*,
    Behavioral_Elements.Common_Behavior.Instance.componentInstance?,
    Behavioral_Elements.Common_Behavior.Instance.stimulus2*,
    Foundation.Core.ModelElement.templateParameter*,
    Foundation.Core.ModelElement.taggedValue*,
    Behavioral_Elements.Common_Behavior.Instance.slot*)?
    >

<!ATTLIST Behavioral_Elements.Common_Behavior.Instance
    %XMI.element.att;
    %XMI.link.att;
>

<!-- _____ -->
<!-- -->
<!-- METAMODEL CLASS: Signal -->

```

6 UML XMI DTD Specification

```
<!-- _____ -->

<!ELEMENT Behavioral_Elements.Common_Behavior.Signal.reception
    (Behavioral_Elements.Common_Behavior.Reception)* >

<!ELEMENT Behavioral_Elements.Common_Behavior.Signal.context (Foundation.Core.BehavioralFeature |
    Behavioral_Elements.Common_Behavior.Reception |
    Foundation.Core.Operation |
    Foundation.Core.Method)*
    >

<!ELEMENT Behavioral_Elements.Common_Behavior.Signal.sendAction
    (Behavioral_Elements.Common_Behavior.SendAction)* >

<!ELEMENT Behavioral_Elements.Common_Behavior.Signal.occurrence
    (Behavioral_Elements.State_Machines.SignalEvent)* >

<!ELEMENT Behavioral_Elements.Common_Behavior.Signal (Foundation.Core.ModelElement.name?,
    Foundation.Core.ModelElement.visibility?,
    Foundation.Core.ModelElement.isSpecification?,
    Foundation.Core.GeneralizableElement.isRoot?,
    Foundation.Core.GeneralizableElement.isLeaf?,
    Foundation.Core.GeneralizableElement.isAbstract?,
    XMI.extension*,
    Foundation.Core.ModelElement.namespace?,
    Foundation.Core.ModelElement.clientDependency*,
    Foundation.Core.ModelElement.constraint*,
    Foundation.Core.ModelElement.supplierDependency*,
    Foundation.Core.ModelElement.presentation*,
    Foundation.Core.ModelElement.targetFlow*,
    Foundation.Core.ModelElement.sourceFlow*,
    Foundation.Core.ModelElement.templateParameter3*,
    Foundation.Core.ModelElement.binding?,
    Foundation.Core.ModelElement.comment*,
    Foundation.Core.ModelElement.elementResidence*,
    Foundation.Core.ModelElement.templateParameter2*,
    Foundation.Core.ModelElement.stereotype?,
    Foundation.Core.ModelElement.behavior*,
    Foundation.Core.ModelElement.classifierRole*,
    Foundation.Core.ModelElement.collaboration*,
    Foundation.Core.ModelElement.partition*,
    Foundation.Core.ModelElement.elementImport*,
    Foundation.Core.GeneralizableElement.generalization*,
    Foundation.Core.GeneralizableElement.specialization*,
    Foundation.Core.Classifier.participant*,
    Foundation.Core.Classifier.powertypeRange*,
    Foundation.Core.Classifier.instance*,
    Foundation.Core.Classifier.createAction*,
    Foundation.Core.Classifier.classifierRole*,
    Foundation.Core.Classifier.collaboration*,
    Foundation.Core.Classifier.classifierInState*,
    Foundation.Core.Classifier.objectFlowState*,
    Behavioral_Elements.Common_Behavior.Signal.reception*,
    Behavioral_Elements.Common_Behavior.Signal.context*,
    Behavioral_Elements.Common_Behavior.Signal.sendAction*,
    Behavioral_Elements.Common_Behavior.Signal.occurrence*,
    Foundation.Core.ModelElement.templateParameter*,
    Foundation.Core.ModelElement.taggedValue*,
    Foundation.Core.Namespace.ownedElement*,
    Foundation.Core.Classifier.feature*)?
    >

<!ATTLIST Behavioral_Elements.Common_Behavior.Signal
    %XMI.element.att;
    %XMI.link.att;
>

<!-- _____ -->
```

```

<!--                                     -->
<!-- METAMODEL CLASS: CreateAction      -->
<!-- _____                        -->

<!ELEMENT Behavioral_Elements.Common_Behavior.CreateAction.instantiation (
    Foundation.Core.Classifier |
    Foundation.Core.Class |
    Foundation.Core.AssociationClass |
    Foundation.Core.DataType |
    Foundation.Core.Interface |
    Foundation.Core.Component |
    Foundation.Core.Node |
    Behavioral_Elements.Common_Behavior.Signal |
    Behavioral_Elements.Common_Behavior.Exception |
    Behavioral_Elements.Use_Cases.UseCase |
    Behavioral_Elements.Use_Cases.Actor |
    Behavioral_Elements.Collaborations.ClassifierRole |
    Behavioral_Elements.Activity_Graphs.ClassifierInState |
    Model_Management.Subsystem)?
    >

<!ELEMENT Behavioral_Elements.Common_Behavior.CreateAction (
    Foundation.Core.ModelElement.name?,
    Foundation.Core.ModelElement.visibility?,
    Foundation.Core.ModelElement.isSpecification?,
    Behavioral_Elements.Common_Behavior.Action.recurrence?,
    Behavioral_Elements.Common_Behavior.Action.target?,
    Behavioral_Elements.Common_Behavior.Action.isAsynchronous?,
    Behavioral_Elements.Common_Behavior.Action.script?,
    XMI.extension*,
    Foundation.Core.ModelElement.namespace?,
    Foundation.Core.ModelElement.clientDependency*,
    Foundation.Core.ModelElement.constraint*,
    Foundation.Core.ModelElement.supplierDependency*,
    Foundation.Core.ModelElement.presentation*,
    Foundation.Core.ModelElement.targetFlow*,
    Foundation.Core.ModelElement.sourceFlow*,
    Foundation.Core.ModelElement.templateParameter3*,
    Foundation.Core.ModelElement.binding?,
    Foundation.Core.ModelElement.comment*,
    Foundation.Core.ModelElement.elementResidence*,
    Foundation.Core.ModelElement.templateParameter2*,
    Foundation.Core.ModelElement.stereotype?,
    Foundation.Core.ModelElement.behavior*,
    Foundation.Core.ModelElement.classifierRole*,
    Foundation.Core.ModelElement.collaboration*,
    Foundation.Core.ModelElement.partition*,
    Foundation.Core.ModelElement.elementImport*,
    Behavioral_Elements.Common_Behavior.Action.actionSequence?,
    Behavioral_Elements.Common_Behavior.Action.stimulus*,
    Behavioral_Elements.Common_Behavior.Action.state1?,
    Behavioral_Elements.Common_Behavior.Action.state2?,
    Behavioral_Elements.Common_Behavior.Action.transition?,
    Behavioral_Elements.Common_Behavior.Action.state3?,
    Behavioral_Elements.Common_Behavior.Action.message*,
    Behavioral_Elements.Common_Behavior.CreateAction.instantiation?,
    Foundation.Core.ModelElement.templateParameter*,
    Foundation.Core.ModelElement.taggedValue*,
    Behavioral_Elements.Common_Behavior.Action.actualArgument*)?
    >

<!ATTLIST Behavioral_Elements.Common_Behavior.CreateAction
    %XMI.element.att;
    %XMI.link.att;
>

<!-- _____                        -->
<!--                                     -->
<!-- METAMODEL CLASS: DestroyAction     -->
<!-- _____                        -->

```

6 UML XMI DTD Specification

```
<!ELEMENT Behavioral_Elements.Common_Behavior.DestroyAction (Foundation.Core.ModelElement.name?,
Foundation.Core.ModelElement.visibility?,
Foundation.Core.ModelElement.isSpecification?,
Behavioral_Elements.Common_Behavior.Action.recurrence?,
Behavioral_Elements.Common_Behavior.Action.target?,
Behavioral_Elements.Common_Behavior.Action.isAsynchronous?,
Behavioral_Elements.Common_Behavior.Action.script?,
XMI.extension*,
Foundation.Core.ModelElement.namespace?,
Foundation.Core.ModelElement.clientDependency*,
Foundation.Core.ModelElement.constraint*,
Foundation.Core.ModelElement.supplierDependency*,
Foundation.Core.ModelElement.presentation*,
Foundation.Core.ModelElement.targetFlow*,
Foundation.Core.ModelElement.sourceFlow*,
Foundation.Core.ModelElement.templateParameter3*,
Foundation.Core.ModelElement.binding?,
Foundation.Core.ModelElement.comment*,
Foundation.Core.ModelElement.elementResidence*,
Foundation.Core.ModelElement.templateParameter2*,
Foundation.Core.ModelElement.stereotype?,
Foundation.Core.ModelElement.behavior*,
Foundation.Core.ModelElement.classifierRole*,
Foundation.Core.ModelElement.collaboration*,
Foundation.Core.ModelElement.partition*,
Foundation.Core.ModelElement.elementImport*,
Behavioral_Elements.Common_Behavior.Action.actionSequence?,
Behavioral_Elements.Common_Behavior.Action.stimulus*,
Behavioral_Elements.Common_Behavior.Action.state1?,
Behavioral_Elements.Common_Behavior.Action.state2?,
Behavioral_Elements.Common_Behavior.Action.transition?,
Behavioral_Elements.Common_Behavior.Action.state3?,
Behavioral_Elements.Common_Behavior.Action.message*,
Foundation.Core.ModelElement.templateParameter*,
Foundation.Core.ModelElement.taggedValue*,
Behavioral_Elements.Common_Behavior.Action.actualArgument*)?
>

<!ATTLIST Behavioral_Elements.Common_Behavior.DestroyAction
    %XMI.element.att;
    %XMI.link.att;
>

<!-- _____ -->
<!-- _____ -->
<!-- METAMODEL CLASS: UninterpretedAction -->
<!-- _____ -->
```

```
<!ELEMENT Behavioral_Elements.Common_Behavior.UninterpretedAction (Foundation.Core.ModelElement.name?,
Foundation.Core.ModelElement.visibility?,
Foundation.Core.ModelElement.isSpecification?,
Behavioral_Elements.Common_Behavior.Action.recurrence?,
Behavioral_Elements.Common_Behavior.Action.target?,
Behavioral_Elements.Common_Behavior.Action.isAsynchronous?,
Behavioral_Elements.Common_Behavior.Action.script?,
XMI.extension*,
Foundation.Core.ModelElement.namespace?,
Foundation.Core.ModelElement.clientDependency*,
Foundation.Core.ModelElement.constraint*,
Foundation.Core.ModelElement.supplierDependency*,
Foundation.Core.ModelElement.presentation*,
Foundation.Core.ModelElement.targetFlow*,
Foundation.Core.ModelElement.sourceFlow*,
Foundation.Core.ModelElement.templateParameter3*,
Foundation.Core.ModelElement.binding?,
Foundation.Core.ModelElement.comment*,
```

6.3 UML XMI DTD

```

Foundation.Core.ModelElement.elementResidence*,
Foundation.Core.ModelElement.templateParameter2*,
Foundation.Core.ModelElement.stereotype?,
Foundation.Core.ModelElement.behavior*,
Foundation.Core.ModelElement.classifierRole*,
Foundation.Core.ModelElement.collaboration*,
Foundation.Core.ModelElement.partition*,
Foundation.Core.ModelElement.elementImport*,
Behavioral_Elements.Common_Behavior.Action.actionSequence?,
Behavioral_Elements.Common_Behavior.Action.stimulus*,
Behavioral_Elements.Common_Behavior.Action.state1?,
Behavioral_Elements.Common_Behavior.Action.state2?,
Behavioral_Elements.Common_Behavior.Action.transition?,
Behavioral_Elements.Common_Behavior.Action.state3?,
Behavioral_Elements.Common_Behavior.Action.message*,
Foundation.Core.ModelElement.templateParameter*,
Foundation.Core.ModelElement.taggedValue*,
Behavioral_Elements.Common_Behavior.Action.actualArgument*]?
>
<!ATTLIST Behavioral_Elements.Common_Behavior.UninterpretedAction
    %XMI.element.att;
    %XMI.link.att;
>
<!-- _____ -->
<!-- _____ -->
<!-- METAMODEL CLASS: Action _____ -->
<!-- _____ -->

<!ELEMENT Behavioral_Elements.Common_Behavior.Action.recurrence
    (Foundation.Data_Types.IterationExpression) >

<!ELEMENT Behavioral_Elements.Common_Behavior.Action.target
    (Foundation.Data_Types.ObjectSetExpression) >

<!ELEMENT Behavioral_Elements.Common_Behavior.Action.isAsynchronous
    EMPTY >
<!ATTLIST Behavioral_Elements.Common_Behavior.Action.isAsynchronous
    xmi.value ( true | false ) #REQUIRED
>

<!ELEMENT Behavioral_Elements.Common_Behavior.Action.script
    (Foundation.Data_Types.ActionExpression) >

<!ELEMENT Behavioral_Elements.Common_Behavior.Action.actionSequence
    (Behavioral_Elements.Common_Behavior.ActionSequence)? >

<!ELEMENT Behavioral_Elements.Common_Behavior.Action.stimulus
    (Behavioral_Elements.Common_Behavior.Stimulus)* >

<!ELEMENT Behavioral_Elements.Common_Behavior.Action.state1 (Behavioral_Elements.State_Machines.State |
    Behavioral_Elements.State_Machines.CompositeState |
    Behavioral_Elements.State_Machines.SubmachineState |
    Behavioral_Elements.Activity_Graphs.SubactivityState |
    Behavioral_Elements.State_Machines.SimpleState |
    Behavioral_Elements.Activity_Graphs.ObjectFlowState |
    Behavioral_Elements.Activity_Graphs.ActionState |
    Behavioral_Elements.Activity_Graphs.CallState |
    Behavioral_Elements.State_Machines.FinalState)?
    >

<!ELEMENT Behavioral_Elements.Common_Behavior.Action.state2 (Behavioral_Elements.State_Machines.State |
    Behavioral_Elements.State_Machines.CompositeState |
    Behavioral_Elements.State_Machines.SubmachineState |
    Behavioral_Elements.Activity_Graphs.SubactivityState |
    Behavioral_Elements.State_Machines.SimpleState |
    Behavioral_Elements.Activity_Graphs.ObjectFlowState |

```

6 UML XMI DTD Specification

```
Behavioral_Elements.Activity_Graphs.ActionState |
Behavioral_Elements.Activity_Graphs.CallState |
Behavioral_Elements.State_Machines.FinalState)?
>

<!ELEMENT Behavioral_Elements.Common_Behavior.Action.transition
      (Behavioral_Elements.State_Machines.Transition)? >

<!ELEMENT Behavioral_Elements.Common_Behavior.Action.state3 (Behavioral_Elements.State_Machines.State |
Behavioral_Elements.State_Machines.CompositeState |
Behavioral_Elements.State_Machines.SubmachineState |
Behavioral_Elements.Activity_Graphs.SubactivityState |
Behavioral_Elements.State_Machines.SimpleState |
Behavioral_Elements.Activity_Graphs.ObjectFlowState |
Behavioral_Elements.Activity_Graphs.ActionState |
Behavioral_Elements.Activity_Graphs.CallState |
Behavioral_Elements.State_Machines.FinalState)?
>

<!ELEMENT Behavioral_Elements.Common_Behavior.Action.message
      (Behavioral_Elements.Collaborations.Message)* >

<!ELEMENT Behavioral_Elements.Common_Behavior.Action (Foundation.Core.ModelElement.name?,
Foundation.Core.ModelElement.visibility?,
Foundation.Core.ModelElement.isSpecification?,
Behavioral_Elements.Common_Behavior.Action.recurrence?,
Behavioral_Elements.Common_Behavior.Action.target?,
Behavioral_Elements.Common_Behavior.Action.isAsynchronous?,
Behavioral_Elements.Common_Behavior.Action.script?,
XMI.extension*,
Foundation.Core.ModelElement.namespace?,
Foundation.Core.ModelElement.clientDependency*,
Foundation.Core.ModelElement.constraint*,
Foundation.Core.ModelElement.supplierDependency*,
Foundation.Core.ModelElement.presentation*,
Foundation.Core.ModelElement.targetFlow*,
Foundation.Core.ModelElement.sourceFlow*,
Foundation.Core.ModelElement.templateParameter3*,
Foundation.Core.ModelElement.binding?,
Foundation.Core.ModelElement.comment*,
Foundation.Core.ModelElement.elementResidence*,
Foundation.Core.ModelElement.templateParameter2*,
Foundation.Core.ModelElement.stereotype?,
Foundation.Core.ModelElement.behavior*,
Foundation.Core.ModelElement.classifierRole*,
Foundation.Core.ModelElement.collaboration*,
Foundation.Core.ModelElement.partition*,
Foundation.Core.ModelElement.elementImport*,
Behavioral_Elements.Common_Behavior.Action.actionSequence?,
Behavioral_Elements.Common_Behavior.Action.stimulus*,
Behavioral_Elements.Common_Behavior.Action.state1?,
Behavioral_Elements.Common_Behavior.Action.state2?,
Behavioral_Elements.Common_Behavior.Action.transition?,
Behavioral_Elements.Common_Behavior.Action.state3?,
Behavioral_Elements.Common_Behavior.Action.message*,
Foundation.Core.ModelElement.templateParameter*,
Foundation.Core.ModelElement.taggedValue*,
Behavioral_Elements.Common_Behavior.Action.actualArgument*)?
>

<!ATTLIST Behavioral_Elements.Common_Behavior.Action
      %XMI.element.att;
      %XMI.link.att;
>

<!-- _____ -->
<!-- _____ -->
<!-- METAMODEL CLASS: AttributeLink -->
<!-- _____ -->
```

```

<!ELEMENT Behavioral_Elements.Common_Behavior.AttributeLink.attribute
                                (Foundation.Core.Attribute)? >

<!ELEMENT Behavioral_Elements.Common_Behavior.AttributeLink.value (Behavioral_Elements.Common_Behavior.Instance |
Behavioral_Elements.Common_Behavior.Object |
Behavioral_Elements.Common_Behavior.LinkObject |
Behavioral_Elements.Common_Behavior.DataValue |
Behavioral_Elements.Common_Behavior.ComponentInstance |
Behavioral_Elements.Common_Behavior.NodeInstance |
Behavioral_Elements.Use_Cases.UseCaseInstance)?
                                >

<!ELEMENT Behavioral_Elements.Common_Behavior.AttributeLink.instance (Behavioral_Elements.Common_Behavior.Instance |
Behavioral_Elements.Common_Behavior.Object |
Behavioral_Elements.Common_Behavior.LinkObject |
Behavioral_Elements.Common_Behavior.DataValue |
Behavioral_Elements.Common_Behavior.ComponentInstance |
Behavioral_Elements.Common_Behavior.NodeInstance |
Behavioral_Elements.Use_Cases.UseCaseInstance)?
                                >

<!ELEMENT Behavioral_Elements.Common_Behavior.AttributeLink.linkEnd
                                (Behavioral_Elements.Common_Behavior.LinkEnd)? >

<!ELEMENT Behavioral_Elements.Common_Behavior.AttributeLink (Foundation.Core.ModelElement.name?,
Foundation.Core.ModelElement.visibility?,
Foundation.Core.ModelElement.isSpecification?,
XMI.extension*,
Foundation.Core.ModelElement.namespace?,
Foundation.Core.ModelElement.clientDependency*,
Foundation.Core.ModelElement.constraint*,
Foundation.Core.ModelElement.supplierDependency*,
Foundation.Core.ModelElement.presentation*,
Foundation.Core.ModelElement.targetFlow*,
Foundation.Core.ModelElement.sourceFlow*,
Foundation.Core.ModelElement.templateParameter3*,
Foundation.Core.ModelElement.binding?,
Foundation.Core.ModelElement.comment*,
Foundation.Core.ModelElement.elementResidence*,
Foundation.Core.ModelElement.templateParameter2*,
Foundation.Core.ModelElement.stereotype?,
Foundation.Core.ModelElement.behavior*,
Foundation.Core.ModelElement.classifierRole*,
Foundation.Core.ModelElement.collaboration*,
Foundation.Core.ModelElement.partition*,
Foundation.Core.ModelElement.elementImport*,
Behavioral_Elements.Common_Behavior.AttributeLink.attribute?,
Behavioral_Elements.Common_Behavior.AttributeLink.value?,
Behavioral_Elements.Common_Behavior.AttributeLink.instance?,
Behavioral_Elements.Common_Behavior.AttributeLink.linkEnd?,
Foundation.Core.ModelElement.templateParameter*,
Foundation.Core.ModelElement.taggedValue*)?
                                >

<!ATTLIST Behavioral_Elements.Common_Behavior.AttributeLink
            %XMI.element.att;
            %XMI.link.att;
>

<!-- _____ -->
<!-- _____ -->
<!-- METAMODEL CLASS: LinkObject -->
<!-- _____ -->

<!ELEMENT Behavioral_Elements.Common_Behavior.LinkObject (Foundation.Core.ModelElement.name?,
Foundation.Core.ModelElement.visibility?,

```

6 UML XMI DTD Specification

```
Foundation.Core.ModelElement.isSpecification?,
XMI.extension*,
Foundation.Core.ModelElement.namespace?,
Foundation.Core.ModelElement.clientDependency*,
Foundation.Core.ModelElement.constraint*,
Foundation.Core.ModelElement.supplierDependency*,
Foundation.Core.ModelElement.presentation*,
Foundation.Core.ModelElement.targetFlow*,
Foundation.Core.ModelElement.sourceFlow*,
Foundation.Core.ModelElement.templateParameter3*,
Foundation.Core.ModelElement.binding?,
Foundation.Core.ModelElement.comment*,
Foundation.Core.ModelElement.elementResidence*,
Foundation.Core.ModelElement.templateParameter2*,
Foundation.Core.ModelElement.stereotype?,
Foundation.Core.ModelElement.behavior*,
Foundation.Core.ModelElement.classifierRole*,
Foundation.Core.ModelElement.collaboration*,
Foundation.Core.ModelElement.partition*,
Foundation.Core.ModelElement.elementImport*,
Behavioral_Elements.Common_Behavior.Instance.classifier*,
Behavioral_Elements.Common_Behavior.Instance.attributeLink*,
Behavioral_Elements.Common_Behavior.Instance.linkEnd*,
Behavioral_Elements.Common_Behavior.Instance.stimulus1*,
Behavioral_Elements.Common_Behavior.Instance.stimulus3*,
Behavioral_Elements.Common_Behavior.Instance.componentInstance?,
Behavioral_Elements.Common_Behavior.Instance.stimulus2*,
Behavioral_Elements.Common_Behavior.Link.association?,
Behavioral_Elements.Common_Behavior.Link.stimulus*,
Foundation.Core.ModelElement.templateParameter*,
Foundation.Core.ModelElement.taggedValue*,
Behavioral_Elements.Common_Behavior.Instance.slot*,
Behavioral_Elements.Common_Behavior.Link.connection*)?
>

<!ATTLIST Behavioral_Elements.Common_Behavior.LinkObject
    %XMI.element.att;
    %XMI.link.att;
>

<!-- _____ -->
<!-- _____ -->
<!-- METAMODEL CLASS: Object -->
<!-- _____ -->

<!ELEMENT Behavioral_Elements.Common_Behavior.Object (Foundation.Core.ModelElement.name?,
Foundation.Core.ModelElement.visibility?,
Foundation.Core.ModelElement.isSpecification?,
XMI.extension*,
Foundation.Core.ModelElement.namespace?,
Foundation.Core.ModelElement.clientDependency*,
Foundation.Core.ModelElement.constraint*,
Foundation.Core.ModelElement.supplierDependency*,
Foundation.Core.ModelElement.presentation*,
Foundation.Core.ModelElement.targetFlow*,
Foundation.Core.ModelElement.sourceFlow*,
Foundation.Core.ModelElement.templateParameter3*,
Foundation.Core.ModelElement.binding?,
Foundation.Core.ModelElement.comment*,
Foundation.Core.ModelElement.elementResidence*,
Foundation.Core.ModelElement.templateParameter2*,
Foundation.Core.ModelElement.stereotype?,
Foundation.Core.ModelElement.behavior*,
Foundation.Core.ModelElement.classifierRole*,
Foundation.Core.ModelElement.collaboration*,
Foundation.Core.ModelElement.partition*,
Foundation.Core.ModelElement.elementImport*,
Behavioral_Elements.Common_Behavior.Instance.classifier*,
```



```

Behavioral_Elements.Common_Behavior.Instance.attributeLink*,
Behavioral_Elements.Common_Behavior.Instance.linkEnd*,
Behavioral_Elements.Common_Behavior.Instance.stimulus1*,
Behavioral_Elements.Common_Behavior.Instance.stimulus3*,
Behavioral_Elements.Common_Behavior.Instance.componentInstance?,
Behavioral_Elements.Common_Behavior.Instance.stimulus2*,
Foundation.Core.ModelElement.templateParameter*,
Foundation.Core.ModelElement.taggedValue*,
Behavioral_Elements.Common_Behavior.Instance.slot*)?
>
<!-- _____ -->
<!-- _____ -->
<!-- METAMODEL CLASS:  DataValue _____ -->
<!-- _____ -->

<!-- _____ -->
<!-- _____ -->
<!-- METAMODEL CLASS:  CallAction _____ -->
<!-- _____ -->

<!-- _____ -->
<!-- _____ -->
<!-- METAMODEL CLASS:  CallAction.operation _____ -->
<!-- _____ -->

```

6 UML XMI DTD Specification

```
<!ELEMENT Behavioral_Elements.Common_Behavior.CallAction (Foundation.Core.ModelElement.name?,
Foundation.Core.ModelElement.visibility?,
Foundation.Core.ModelElement.isSpecification?,
Behavioral_Elements.Common_Behavior.Action.recurrence?,
Behavioral_Elements.Common_Behavior.Action.target?,
Behavioral_Elements.Common_Behavior.Action.isAsynchronous?,
Behavioral_Elements.Common_Behavior.Action.script?,
XMI.extension*,
Foundation.Core.ModelElement.namespace?,
Foundation.Core.ModelElement.clientDependency*,
Foundation.Core.ModelElement.constraint*,
Foundation.Core.ModelElement.supplierDependency*,
Foundation.Core.ModelElement.presentation*,
Foundation.Core.ModelElement.targetFlow*,
Foundation.Core.ModelElement.sourceFlow*,
Foundation.Core.ModelElement.templateParameter3*,
Foundation.Core.ModelElement.binding?,
Foundation.Core.ModelElement.comment*,
Foundation.Core.ModelElement.elementResidence*,
Foundation.Core.ModelElement.templateParameter2*,
Foundation.Core.ModelElement.stereotype?,
Foundation.Core.ModelElement.behavior*,
Foundation.Core.ModelElement.classifierRole*,
Foundation.Core.ModelElement.collaboration*,
Foundation.Core.ModelElement.partition*,
Foundation.Core.ModelElement.elementImport*,
Behavioral_Elements.Common_Behavior.Action.actionSequence?,
Behavioral_Elements.Common_Behavior.Action.stimulus*,
Behavioral_Elements.Common_Behavior.Action.state1?,
Behavioral_Elements.Common_Behavior.Action.state2?,
Behavioral_Elements.Common_Behavior.Action.transition?,
Behavioral_Elements.Common_Behavior.Action.state3?,
Behavioral_Elements.Common_Behavior.Action.message*,
Behavioral_Elements.Common_Behavior.CallAction.operation?,
Foundation.Core.ModelElement.templateParameter*,
Foundation.Core.ModelElement.taggedValue*,
Behavioral_Elements.Common_Behavior.Action.actualArgument*)?
>

<!ATTLIST Behavioral_Elements.Common_Behavior.CallAction
    %XMI.element.att;
    %XMI.link.att;
>

<!-- _____ -->
<!-- _____ -->
<!-- METAMODEL CLASS:  SendAction _____ -->
<!-- _____ -->

<!ELEMENT Behavioral_Elements.Common_Behavior.SendAction.signal (Behavioral_Elements.Common_Behavior.Signal |
Behavioral_Elements.Common_Behavior.Exception)?
>

<!ELEMENT Behavioral_Elements.Common_Behavior.SendAction (Foundation.Core.ModelElement.name?,
Foundation.Core.ModelElement.visibility?,
Foundation.Core.ModelElement.isSpecification?,
Behavioral_Elements.Common_Behavior.Action.recurrence?,
Behavioral_Elements.Common_Behavior.Action.target?,
Behavioral_Elements.Common_Behavior.Action.isAsynchronous?,
Behavioral_Elements.Common_Behavior.Action.script?,
XMI.extension*,
Foundation.Core.ModelElement.namespace?,
Foundation.Core.ModelElement.clientDependency*,
Foundation.Core.ModelElement.constraint*,
Foundation.Core.ModelElement.supplierDependency*,
Foundation.Core.ModelElement.presentation*,
Foundation.Core.ModelElement.targetFlow*,
Foundation.Core.ModelElement.sourceFlow*,
```

```

Foundation.Core.ModelElement.templateParameter3*,
Foundation.Core.ModelElement.binding?,
Foundation.Core.ModelElement.comment*,
Foundation.Core.ModelElement.elementResidence*,
Foundation.Core.ModelElement.templateParameter2*,
Foundation.Core.ModelElement.stereotype?,
Foundation.Core.ModelElement.behavior*,
Foundation.Core.ModelElement.classifierRole*,
Foundation.Core.ModelElement.collaboration*,
Foundation.Core.ModelElement.partition*,
Foundation.Core.ModelElement.elementImport*,
Behavioral_Elements.Common_Behavior.Action.actionSequence?,
Behavioral_Elements.Common_Behavior.Action.stimulus*,
Behavioral_Elements.Common_Behavior.Action.state1?,
Behavioral_Elements.Common_Behavior.Action.state2?,
Behavioral_Elements.Common_Behavior.Action.transition?,
Behavioral_Elements.Common_Behavior.Action.state3?,
Behavioral_Elements.Common_Behavior.Action.message*,
Behavioral_Elements.Common_Behavior.SendAction.signal?,
Foundation.Core.ModelElement.templateParameter*,
Foundation.Core.ModelElement.taggedValue*,
Behavioral_Elements.Common_Behavior.Action.actualArgument*)?
>

<!-- Behavioral_Elements.Common_Behavior.SendAction
      %XMI.element.att;
      %XMI.link.att;
-->

<!-- _____ -->
<!-- _____ -->
<!-- METAMODEL CLASS: ActionSequence -->
<!-- _____ -->

<!-- ELEMENT Behavioral_Elements.Common_Behavior.ActionSequence (Foundation.Core.ModelElement.name?,
      Foundation.Core.ModelElement.visibility?,
      Foundation.Core.ModelElement.isSpecification?,
      Behavioral_Elements.Common_Behavior.Action.recurrence?,
      Behavioral_Elements.Common_Behavior.Action.target?,
      Behavioral_Elements.Common_Behavior.Action.isAsynchronous?,
      Behavioral_Elements.Common_Behavior.Action.script?,
      XMI.extension*,
      Foundation.Core.ModelElement.namespace?,
      Foundation.Core.ModelElement.clientDependency*,
      Foundation.Core.ModelElement.constraint*,
      Foundation.Core.ModelElement.supplierDependency*,
      Foundation.Core.ModelElement.presentation*,
      Foundation.Core.ModelElement.targetFlow*,
      Foundation.Core.ModelElement.sourceFlow*,
      Foundation.Core.ModelElement.templateParameter3*,
      Foundation.Core.ModelElement.binding?,
      Foundation.Core.ModelElement.comment*,
      Foundation.Core.ModelElement.elementResidence*,
      Foundation.Core.ModelElement.templateParameter2*,
      Foundation.Core.ModelElement.stereotype?,
      Foundation.Core.ModelElement.behavior*,
      Foundation.Core.ModelElement.classifierRole*,
      Foundation.Core.ModelElement.collaboration*,
      Foundation.Core.ModelElement.partition*,
      Foundation.Core.ModelElement.elementImport*,
      Behavioral_Elements.Common_Behavior.Action.actionSequence?,
      Behavioral_Elements.Common_Behavior.Action.stimulus*,
      Behavioral_Elements.Common_Behavior.Action.state1?,
      Behavioral_Elements.Common_Behavior.Action.state2?,
      Behavioral_Elements.Common_Behavior.Action.transition?,
      Behavioral_Elements.Common_Behavior.Action.state3?,
      Behavioral_Elements.Common_Behavior.Action.message*,
      Foundation.Core.ModelElement.templateParameter*,

```

6 UML XMI DTD Specification

```

Foundation.Core.ModelElement.taggedValue*,
Behavioral_Elements.Common_Behavior.Action.actualArgument*,
Behavioral_Elements.Common_Behavior.ActionSequence.action*)?
>
<!ATTLIST Behavioral_Elements.Common_Behavior.ActionSequence
    %XMI.element.att;
    %XMI.link.att;
>
<!-- _____ -->
<!-- _____ -->
<!-- METAMODEL CLASS: Argument _____ -->
<!-- _____ -->

<!ELEMENT Behavioral_Elements.Common_Behavior.Argument.value (Foundation.Data_Types.Expression |
    Foundation.Data_Types.BooleanExpression |
    Foundation.Data_Types.ActionExpression |
    Foundation.Data_Types.IterationExpression |
    Foundation.Data_Types.TypeExpression |
    Foundation.Data_Types.ArgListsExpression |
    Foundation.Data_Types.MappingExpression |
    Foundation.Data_Types.ProcedureExpression |
    Foundation.Data_Types.TimeExpression |
    Foundation.Data_Types.ObjectSetExpression)
>

<!ELEMENT Behavioral_Elements.Common_Behavior.Argument.action (Behavioral_Elements.Common_Behavior.Action |
    Behavioral_Elements.Common_Behavior.CallAction |
    Behavioral_Elements.Common_Behavior.SendAction |
    Behavioral_Elements.Common_Behavior.ActionSequence |
    Behavioral_Elements.Common_Behavior.ReturnAction |
    Behavioral_Elements.Common_Behavior.TerminateAction |
    Behavioral_Elements.Common_Behavior.DestroyAction |
    Behavioral_Elements.Common_Behavior.CreateAction |
    Behavioral_Elements.Common_Behavior.UninterpretedAction)?
>

<!ELEMENT Behavioral_Elements.Common_Behavior.Argument (Foundation.Core.ModelElement.name?,
    Foundation.Core.ModelElement.visibility?,
    Foundation.Core.ModelElement.isSpecification?,
    Behavioral_Elements.Common_Behavior.Argument.value?,
    XMI.extension*,
    Foundation.Core.ModelElement.namespace?,
    Foundation.Core.ModelElement.clientDependency*,
    Foundation.Core.ModelElement.constraint*,
    Foundation.Core.ModelElement.supplierDependency*,
    Foundation.Core.ModelElement.presentation*,
    Foundation.Core.ModelElement.targetFlow*,
    Foundation.Core.ModelElement.sourceFlow*,
    Foundation.Core.ModelElement.templateParameter3*,
    Foundation.Core.ModelElement.binding?,
    Foundation.Core.ModelElement.comment*,
    Foundation.Core.ModelElement.elementResidence*,
    Foundation.Core.ModelElement.templateParameter2*,
    Foundation.Core.ModelElement.stereotype?,
    Foundation.Core.ModelElement.behavior*,
    Foundation.Core.ModelElement.classifierRole*,
    Foundation.Core.ModelElement.collaboration*,
    Foundation.Core.ModelElement.partition*,
    Foundation.Core.ModelElement.elementImport*,
    Behavioral_Elements.Common_Behavior.Argument.action?,
    Foundation.Core.ModelElement.templateParameter*,
    Foundation.Core.ModelElement.taggedValue* )?
>

<!ATTLIST Behavioral_Elements.Common_Behavior.Argument
    %XMI.element.att;
    %XMI.link.att;
```

```

>
<!-- _____ -->
<!-- _____ -->
<!-- METAMODEL CLASS: Reception _____ -->
<!-- _____ -->

<!ELEMENT Behavioral_Elements.Common_Behavior.Reception.specification (#PCDATA |
                                                                    XMI.reference)*
>

<!ELEMENT Behavioral_Elements.Common_Behavior.Reception.isRoot EMPTY >
<!ATTLIST Behavioral_Elements.Common_Behavior.Reception.isRoot
        xmi.value ( true | false ) #REQUIRED
>

<!ELEMENT Behavioral_Elements.Common_Behavior.Reception.isLeaf EMPTY >
<!ATTLIST Behavioral_Elements.Common_Behavior.Reception.isLeaf
        xmi.value ( true | false ) #REQUIRED
>

<!ELEMENT Behavioral_Elements.Common_Behavior.Reception.isAbstract
                                                                    EMPTY >
<!ATTLIST Behavioral_Elements.Common_Behavior.Reception.isAbstract
        xmi.value ( true | false ) #REQUIRED
>

<!ELEMENT Behavioral_Elements.Common_Behavior.Reception.signal (Behavioral_Elements.Common_Behavior.Signal |
                                                                    Behavioral_Elements.Common_Behavior.Exception)?
>

<!ELEMENT Behavioral_Elements.Common_Behavior.Reception (Foundation.Core.ModelElement.name?,
                                                                    Foundation.Core.ModelElement.visibility?,
                                                                    Foundation.Core.ModelElement.isSpecification?,
                                                                    Foundation.Core.Feature.ownerScope?,
                                                                    Foundation.Core.BehavioralFeature.isQuery?,
                                                                    Behavioral_Elements.Common_Behavior.Reception.specification?,
                                                                    Behavioral_Elements.Common_Behavior.Reception.isRoot?,
                                                                    Behavioral_Elements.Common_Behavior.Reception.isLeaf?,
                                                                    Behavioral_Elements.Common_Behavior.Reception.isAbstract?,
                                                                    XMI.extension*,
                                                                    Foundation.Core.ModelElement.namespace?,
                                                                    Foundation.Core.ModelElement.clientDependency*,
                                                                    Foundation.Core.ModelElement.constraint*,
                                                                    Foundation.Core.ModelElement.supplierDependency*,
                                                                    Foundation.Core.ModelElement.presentation*,
                                                                    Foundation.Core.ModelElement.targetFlow*,
                                                                    Foundation.Core.ModelElement.sourceFlow*,
                                                                    Foundation.Core.ModelElement.templateParameter3*,
                                                                    Foundation.Core.ModelElement.binding?,
                                                                    Foundation.Core.ModelElement.comment*,
                                                                    Foundation.Core.ModelElement.elementResidence*,
                                                                    Foundation.Core.ModelElement.templateParameter2*,
                                                                    Foundation.Core.ModelElement.stereotype?,
                                                                    Foundation.Core.ModelElement.behavior*,
                                                                    Foundation.Core.ModelElement.classifierRole*,
                                                                    Foundation.Core.ModelElement.collaboration*,
                                                                    Foundation.Core.ModelElement.partition*,
                                                                    Foundation.Core.ModelElement.elementImport*,
                                                                    Foundation.Core.Feature.owner?,
                                                                    Foundation.Core.Feature.classifierRole*,
                                                                    Foundation.Core.BehavioralFeature.raisedSignal*,
                                                                    Behavioral_Elements.Common_Behavior.Reception.signal?,
                                                                    Foundation.Core.ModelElement.templateParameter*,
                                                                    Foundation.Core.ModelElement.taggedValue*,
                                                                    Foundation.Core.BehavioralFeature.parameter*)?
>

```

6 UML XMI DTD Specification

```
<!ATTLIST Behavioral_Elements.Common_Behavior.Reception
    %XMI.element.att;
    %XMI.link.att;
>

<!-- _____ -->
<!-- _____ -->
<!-- METAMODEL CLASS: Link _____ -->
<!-- _____ -->

<!ELEMENT Behavioral_Elements.Common_Behavior.Link.association (Foundation.Core.Association |
    Foundation.Core.AssociationClass |
    Behavioral_Elements.Collaborations.AssociationRole)?
>

<!ELEMENT Behavioral_Elements.Common_Behavior.Link.stimulus
    (Behavioral_Elements.Common_Behavior.Stimulus)* >

<!ELEMENT Behavioral_Elements.Common_Behavior.Link (Foundation.Core.ModelElement.name?,
    Foundation.Core.ModelElement.visibility?,
    Foundation.Core.ModelElement.isSpecification?,
    XMI.extension*,
    Foundation.Core.ModelElement.namespace?,
    Foundation.Core.ModelElement.clientDependency*,
    Foundation.Core.ModelElement.constraint*,
    Foundation.Core.ModelElement.supplierDependency*,
    Foundation.Core.ModelElement.presentation*,
    Foundation.Core.ModelElement.targetFlow*,
    Foundation.Core.ModelElement.sourceFlow*,
    Foundation.Core.ModelElement.templateParameter3*,
    Foundation.Core.ModelElement.binding?,
    Foundation.Core.ModelElement.comment*,
    Foundation.Core.ModelElement.elementResidence*,
    Foundation.Core.ModelElement.templateParameter2*,
    Foundation.Core.ModelElement.stereotype?,
    Foundation.Core.ModelElement.behavior*,
    Foundation.Core.ModelElement.classifierRole*,
    Foundation.Core.ModelElement.collaboration*,
    Foundation.Core.ModelElement.partition*,
    Foundation.Core.ModelElement.elementImport*,
    Behavioral_Elements.Common_Behavior.Link.association?,
    Behavioral_Elements.Common_Behavior.Link.stimulus*,
    Foundation.Core.ModelElement.templateParameter*,
    Foundation.Core.ModelElement.taggedValue*,
    Behavioral_Elements.Common_Behavior.Link.connection*)?
>

<!ATTLIST Behavioral_Elements.Common_Behavior.Link
    %XMI.element.att;
    %XMI.link.att;
>

<!-- _____ -->
<!-- _____ -->
<!-- METAMODEL CLASS: LinkEnd _____ -->
<!-- _____ -->

<!ELEMENT Behavioral_Elements.Common_Behavior.LinkEnd.instance (Behavioral_Elements.Common_Behavior.Instance |
    Behavioral_Elements.Common_Behavior.Object |
    Behavioral_Elements.Common_Behavior.LinkObject |
    Behavioral_Elements.Common_Behavior.DataValue |
    Behavioral_Elements.Common_Behavior.ComponentInstance |
    Behavioral_Elements.Common_Behavior.NodeInstance |
    Behavioral_Elements.Use_Cases.UseCaseInstance)?
>

<!ELEMENT Behavioral_Elements.Common_Behavior.LinkEnd.link (Behavioral_Elements.Common_Behavior.Link |
```

```

Behavioral_Elements.Common_Behavior.LinkObject)?
>

<!ELEMENT Behavioral_Elements.Common_Behavior.LinkEnd.associationEnd (Foundation.Core.AssociationEnd |
Behavioral_Elements.Collaborations.AssociationEndRole)?
>

<!ELEMENT Behavioral_Elements.Common_Behavior.LinkEnd (Foundation.Core.ModelElement.name?,
Foundation.Core.ModelElement.visibility?,
Foundation.Core.ModelElement.isSpecification?,
XMI.extension*,
Foundation.Core.ModelElement.namespace?,
Foundation.Core.ModelElement.clientDependency*,
Foundation.Core.ModelElement.constraint*,
Foundation.Core.ModelElement.supplierDependency*,
Foundation.Core.ModelElement.presentation*,
Foundation.Core.ModelElement.targetFlow*,
Foundation.Core.ModelElement.sourceFlow*,
Foundation.Core.ModelElement.templateParameter3*,
Foundation.Core.ModelElement.binding?,
Foundation.Core.ModelElement.comment*,
Foundation.Core.ModelElement.elementResidence*,
Foundation.Core.ModelElement.templateParameter2*,
Foundation.Core.ModelElement.stereotype?,
Foundation.Core.ModelElement.behavior*,
Foundation.Core.ModelElement.classifierRole*,
Foundation.Core.ModelElement.collaboration*,
Foundation.Core.ModelElement.partition*,
Foundation.Core.ModelElement.elementImport*,
Behavioral_Elements.Common_Behavior.LinkEnd.instance?,
Behavioral_Elements.Common_Behavior.LinkEnd.link?,
Behavioral_Elements.Common_Behavior.LinkEnd.associationEnd?,
Foundation.Core.ModelElement.templateParameter*,
Foundation.Core.ModelElement.taggedValue*,
Behavioral_Elements.Common_Behavior.LinkEnd.qualifiedValue*)?
>

<!ATTLIST Behavioral_Elements.Common_Behavior.LinkEnd
    %XMI.element.att;
    %XMI.link.att;
>

<!-- _____ -->
<!-- _____ -->
<!-- METAMODEL CLASS: ReturnAction -->
<!-- _____ -->

<!ELEMENT Behavioral_Elements.Common_Behavior.ReturnAction (Foundation.Core.ModelElement.name?,
Foundation.Core.ModelElement.visibility?,
Foundation.Core.ModelElement.isSpecification?,
Behavioral_Elements.Common_Behavior.Action.recurrence?,
Behavioral_Elements.Common_Behavior.Action.target?,
Behavioral_Elements.Common_Behavior.Action.isAsynchronous?,
Behavioral_Elements.Common_Behavior.Action.script?,
XMI.extension*,
Foundation.Core.ModelElement.namespace?,
Foundation.Core.ModelElement.clientDependency*,
Foundation.Core.ModelElement.constraint*,
Foundation.Core.ModelElement.supplierDependency*,
Foundation.Core.ModelElement.presentation*,
Foundation.Core.ModelElement.targetFlow*,
Foundation.Core.ModelElement.sourceFlow*,
Foundation.Core.ModelElement.templateParameter3*,
Foundation.Core.ModelElement.binding?,
Foundation.Core.ModelElement.comment*,
Foundation.Core.ModelElement.elementResidence*,
Foundation.Core.ModelElement.templateParameter2*,
Foundation.Core.ModelElement.stereotype?,

```

6 UML XMI DTD Specification

```
Foundation.Core.ModelElement.behavior*,
Foundation.Core.ModelElement.classifierRole*,
Foundation.Core.ModelElement.collaboration*,
Foundation.Core.ModelElement.partition*,
Foundation.Core.ModelElement.elementImport*,
Behavioral_Elements.Common_Behavior.Action.actionSequence?,
Behavioral_Elements.Common_Behavior.Action.stimulus*,
Behavioral_Elements.Common_Behavior.Action.state1?,
Behavioral_Elements.Common_Behavior.Action.state2?,
Behavioral_Elements.Common_Behavior.Action.transition?,
Behavioral_Elements.Common_Behavior.Action.state3?,
Behavioral_Elements.Common_Behavior.Action.message*,
Foundation.Core.ModelElement.templateParameter*,
Foundation.Core.ModelElement.taggedValue*,
Behavioral_Elements.Common_Behavior.Action.actualArgument*)?
>

<!ATTLIST Behavioral_Elements.Common_Behavior.ReturnAction
    %XMI.element.att;
    %XMI.link.att;
>

<!-- _____ -->
<!-- _____ -->
<!-- METAMODEL CLASS: TerminateAction _____ -->
<!-- _____ -->

<!ELEMENT Behavioral_Elements.Common_Behavior.TerminateAction (Foundation.Core.ModelElement.name?,
    Foundation.Core.ModelElement.visibility?,
    Foundation.Core.ModelElement.isSpecification?,
    Behavioral_Elements.Common_Behavior.Action.recurrence?,
    Behavioral_Elements.Common_Behavior.Action.target?,
    Behavioral_Elements.Common_Behavior.Action.isAsynchronous?,
    Behavioral_Elements.Common_Behavior.Action.script?,
    XMI.extension*,
    Foundation.Core.ModelElement.namespace?,
    Foundation.Core.ModelElement.clientDependency*,
    Foundation.Core.ModelElement.constraint*,
    Foundation.Core.ModelElement.supplierDependency*,
    Foundation.Core.ModelElement.presentation*,
    Foundation.Core.ModelElement.targetFlow*,
    Foundation.Core.ModelElement.sourceFlow*,
    Foundation.Core.ModelElement.templateParameter3*,
    Foundation.Core.ModelElement.binding?,
    Foundation.Core.ModelElement.comment*,
    Foundation.Core.ModelElement.elementResidence*,
    Foundation.Core.ModelElement.templateParameter2*,
    Foundation.Core.ModelElement.stereotype?,
    Foundation.Core.ModelElement.behavior*,
    Foundation.Core.ModelElement.classifierRole*,
    Foundation.Core.ModelElement.collaboration*,
    Foundation.Core.ModelElement.partition*,
    Foundation.Core.ModelElement.elementImport*,
    Behavioral_Elements.Common_Behavior.Action.actionSequence?,
    Behavioral_Elements.Common_Behavior.Action.stimulus*,
    Behavioral_Elements.Common_Behavior.Action.state1?,
    Behavioral_Elements.Common_Behavior.Action.state2?,
    Behavioral_Elements.Common_Behavior.Action.transition?,
    Behavioral_Elements.Common_Behavior.Action.state3?,
    Behavioral_Elements.Common_Behavior.Action.message*,
    Foundation.Core.ModelElement.templateParameter*,
    Foundation.Core.ModelElement.taggedValue*,
    Behavioral_Elements.Common_Behavior.Action.actualArgument*)?
>

<!ATTLIST Behavioral_Elements.Common_Behavior.TerminateAction
    %XMI.element.att;
    %XMI.link.att;
>
```



```

<!-- _____ -->
<!-- -->
<!-- METAMODEL CLASS: Stimulus -->
<!-- _____ -->

<!ELEMENT Behavioral_Elements.Common_Behavior.Stimulus.argument (Behavioral_Elements.Common_Behavior.Instance |
    Behavioral_Elements.Common_Behavior.Object |
    Behavioral_Elements.Common_Behavior.LinkObject |
    Behavioral_Elements.Common_Behavior.DataValue |
    Behavioral_Elements.Common_Behavior.ComponentInstance |
    Behavioral_Elements.Common_Behavior.NodeInstance |
    Behavioral_Elements.Use_Cases.UseCaseInstance)*
>

<!ELEMENT Behavioral_Elements.Common_Behavior.Stimulus.sender (Behavioral_Elements.Common_Behavior.Instance |
    Behavioral_Elements.Common_Behavior.Object |
    Behavioral_Elements.Common_Behavior.LinkObject |
    Behavioral_Elements.Common_Behavior.DataValue |
    Behavioral_Elements.Common_Behavior.ComponentInstance |
    Behavioral_Elements.Common_Behavior.NodeInstance |
    Behavioral_Elements.Use_Cases.UseCaseInstance)?
>

<!ELEMENT Behavioral_Elements.Common_Behavior.Stimulus.receiver (Behavioral_Elements.Common_Behavior.Instance |
    Behavioral_Elements.Common_Behavior.Object |
    Behavioral_Elements.Common_Behavior.LinkObject |
    Behavioral_Elements.Common_Behavior.DataValue |
    Behavioral_Elements.Common_Behavior.ComponentInstance |
    Behavioral_Elements.Common_Behavior.NodeInstance |
    Behavioral_Elements.Use_Cases.UseCaseInstance)?
>

<!ELEMENT Behavioral_Elements.Common_Behavior.Stimulus.communicationLink (Behavioral_Elements.Common_Behavior.Link |
    Behavioral_Elements.Common_Behavior.LinkObject)?
>

<!ELEMENT Behavioral_Elements.Common_Behavior.Stimulus.dispatchAction (Behavioral_Elements.Common_Behavior.Action |
    Behavioral_Elements.Common_Behavior.CallAction |
    Behavioral_Elements.Common_Behavior.SendAction |
    Behavioral_Elements.Common_Behavior.ActionSequence |
    Behavioral_Elements.Common_Behavior.ReturnAction |
    Behavioral_Elements.Common_Behavior.TerminateAction |
    Behavioral_Elements.Common_Behavior.DestroyAction |
    Behavioral_Elements.Common_Behavior.CreateAction |
    Behavioral_Elements.Common_Behavior.UninterpretedAction)?
>

<!ELEMENT Behavioral_Elements.Common_Behavior.Stimulus (Foundation.Core.ModelElement.name?,
    Foundation.Core.ModelElement.visibility?,
    Foundation.Core.ModelElement.isSpecification?,
    XMI.extension*,
    Foundation.Core.ModelElement.namespace?,
    Foundation.Core.ModelElement.clientDependency*,
    Foundation.Core.ModelElement.constraint*,
    Foundation.Core.ModelElement.supplierDependency*,
    Foundation.Core.ModelElement.presentation*,
    Foundation.Core.ModelElement.targetFlow*,
    Foundation.Core.ModelElement.sourceFlow*,
    Foundation.Core.ModelElement.templateParameter3*,
    Foundation.Core.ModelElement.binding?,
    Foundation.Core.ModelElement.comment*,
    Foundation.Core.ModelElement.elementResidence*,
    Foundation.Core.ModelElement.templateParameter2*,
    Foundation.Core.ModelElement.stereotype?,
    Foundation.Core.ModelElement.behavior*,
    Foundation.Core.ModelElement.classifierRole*,

```

6 UML XMI DTD Specification

```
Foundation.Core.ModelElement.collaboration*,
Foundation.Core.ModelElement.partition*,
Foundation.Core.ModelElement.elementImport*,
Behavioral_Elements.Common_Behavior.Stimulus.argument*,
Behavioral_Elements.Common_Behavior.Stimulus.sender?,
Behavioral_Elements.Common_Behavior.Stimulus.receiver?,
Behavioral_Elements.Common_Behavior.Stimulus.communicationLink?,
Behavioral_Elements.Common_Behavior.Stimulus.dispatchAction?,
Foundation.Core.ModelElement.templateParameter*,
Foundation.Core.ModelElement.taggedValue*)?
>

<!ATTLIST Behavioral_Elements.Common_Behavior.Stimulus
    %XMI.element.att;
    %XMI.link.att;
>

<!-- _____ -->
<!-- -->
<!-- METAMODEL CLASS: Exception -->
<!-- _____ -->

<!ELEMENT Behavioral_Elements.Common_Behavior.Exception (
    Foundation.Core.ModelElement.name?,
    Foundation.Core.ModelElement.visibility?,
    Foundation.Core.ModelElement.isSpecification?,
    Foundation.Core.GeneralizableElement.isRoot?,
    Foundation.Core.GeneralizableElement.isLeaf?,
    Foundation.Core.GeneralizableElement.isAbstract?,
    XMI.extension*,
    Foundation.Core.ModelElement.namespace?,
    Foundation.Core.ModelElement.clientDependency*,
    Foundation.Core.ModelElement.constraint*,
    Foundation.Core.ModelElement.supplierDependency*,
    Foundation.Core.ModelElement.presentation*,
    Foundation.Core.ModelElement.targetFlow*,
    Foundation.Core.ModelElement.sourceFlow*,
    Foundation.Core.ModelElement.templateParameter3*,
    Foundation.Core.ModelElement.binding?,
    Foundation.Core.ModelElement.comment*,
    Foundation.Core.ModelElement.elementResidence*,
    Foundation.Core.ModelElement.templateParameter2*,
    Foundation.Core.ModelElement.stereotype?,
    Foundation.Core.ModelElement.behavior*,
    Foundation.Core.ModelElement.classifierRole*,
    Foundation.Core.ModelElement.collaboration*,
    Foundation.Core.ModelElement.partition*,
    Foundation.Core.ModelElement.elementImport*,
    Foundation.Core.GeneralizableElement.generalization*,
    Foundation.Core.GeneralizableElement.specialization*,
    Foundation.Core.Classifier.participant*,
    Foundation.Core.Classifier.powertypeRange*,
    Foundation.Core.Classifier.instance*,
    Foundation.Core.Classifier.createAction*,
    Foundation.Core.Classifier.classifierRole*,
    Foundation.Core.Classifier.collaboration*,
    Foundation.Core.Classifier.classifierInState*,
    Foundation.Core.Classifier.objectFlowState*,
    Behavioral_Elements.Common_Behavior.Signal.reception*,
    Behavioral_Elements.Common_Behavior.Signal.context*,
    Behavioral_Elements.Common_Behavior.Signal.sendAction*,
    Behavioral_Elements.Common_Behavior.Signal.occurrence*,
    Foundation.Core.ModelElement.templateParameter*,
    Foundation.Core.ModelElement.taggedValue*,
    Foundation.Core.Namespace.ownedElement*,
    Foundation.Core.Classifier.feature*)?
>

<!ATTLIST Behavioral_Elements.Common_Behavior.Exception
    %XMI.element.att;
```

```

        %XMI.link.att;
    >

<!-- _____ -->
<!-- _____ -->
<!-- METAMODEL CLASS: ComponentInstance -->
<!-- _____ -->

<!ELEMENT Behavioral_Elements.Common_Behavior.ComponentInstance
        (Behavioral_Elements.Common_Behavior.NodeInstance)? >

<!ELEMENT Behavioral_Elements.Common_Behavior.ComponentInstance.resident (Behavioral_Elements.Common_Behavior.Instance |
        Behavioral_Elements.Common_Behavior.Object |
        Behavioral_Elements.Common_Behavior.LinkObject |
        Behavioral_Elements.Common_Behavior.DataValue |
        Behavioral_Elements.Common_Behavior.ComponentInstance |
        Behavioral_Elements.Common_Behavior.NodeInstance |
        Behavioral_Elements.Use_Cases.UseCaseInstance)*
    >

<!ELEMENT Behavioral_Elements.Common_Behavior.ComponentInstance (Foundation.Core.ModelElement.name?,
        Foundation.Core.ModelElement.visibility?,
        Foundation.Core.ModelElement.isSpecification?,
        XMI.extension*,
        Foundation.Core.ModelElement.namespace?,
        Foundation.Core.ModelElement.clientDependency*,
        Foundation.Core.ModelElement.constraint*,
        Foundation.Core.ModelElement.supplierDependency*,
        Foundation.Core.ModelElement.presentation*,
        Foundation.Core.ModelElement.targetFlow*,
        Foundation.Core.ModelElement.sourceFlow*,
        Foundation.Core.ModelElement.templateParameter3*,
        Foundation.Core.ModelElement.binding?,
        Foundation.Core.ModelElement.comment*,
        Foundation.Core.ModelElement.elementResidence*,
        Foundation.Core.ModelElement.templateParameter2*,
        Foundation.Core.ModelElement.stereotype?,
        Foundation.Core.ModelElement.behavior*,
        Foundation.Core.ModelElement.classifierRole*,
        Foundation.Core.ModelElement.collaboration*,
        Foundation.Core.ModelElement.partition*,
        Foundation.Core.ModelElement.elementImport*,
        Behavioral_Elements.Common_Behavior.Instance.classifier*,
        Behavioral_Elements.Common_Behavior.Instance.attributeLink*,
        Behavioral_Elements.Common_Behavior.Instance.linkEnd*,
        Behavioral_Elements.Common_Behavior.Instance.stimulus1*,
        Behavioral_Elements.Common_Behavior.Instance.stimulus3*,
        Behavioral_Elements.Common_Behavior.Instance.componentInstance?,
        Behavioral_Elements.Common_Behavior.Instance.stimulus2*,
        Behavioral_Elements.Common_Behavior.ComponentInstance.nodeInstance?,
        Behavioral_Elements.Common_Behavior.ComponentInstance.resident*,
        Foundation.Core.ModelElement.templateParameter*,
        Foundation.Core.ModelElement.taggedValue*,
        Behavioral_Elements.Common_Behavior.Instance.slot*)?
    >

<!ATTLIST Behavioral_Elements.Common_Behavior.ComponentInstance
        %XMI.element.att;
        %XMI.link.att;
    >

<!-- _____ -->
<!-- _____ -->
<!-- METAMODEL CLASS: NodeInstance -->
<!-- _____ -->

<!ELEMENT Behavioral_Elements.Common_Behavior.NodeInstance.resident

```

6 UML XMI DTD Specification

```
(Behavioral_Elements.Common_Behavior.ComponentInstance)* >

<!ELEMENT Behavioral_Elements.Common_Behavior.NodeInstance (Foundation.Core.ModelElement.name?,
Foundation.Core.ModelElement.visibility?,
Foundation.Core.ModelElement.isSpecification?,
XMI.extension*,
Foundation.Core.ModelElement.namespace?,
Foundation.Core.ModelElement.clientDependency*,
Foundation.Core.ModelElement.constraint*,
Foundation.Core.ModelElement.supplierDependency*,
Foundation.Core.ModelElement.presentation*,
Foundation.Core.ModelElement.targetFlow*,
Foundation.Core.ModelElement.sourceFlow*,
Foundation.Core.ModelElement.templateParameter3*,
Foundation.Core.ModelElement.binding?,
Foundation.Core.ModelElement.comment*,
Foundation.Core.ModelElement.elementResidence*,
Foundation.Core.ModelElement.templateParameter2*,
Foundation.Core.ModelElement.stereotype?,
Foundation.Core.ModelElement.behavior*,
Foundation.Core.ModelElement.classifierRole*,
Foundation.Core.ModelElement.collaboration*,
Foundation.Core.ModelElement.partition*,
Foundation.Core.ModelElement.elementImport*,
Behavioral_Elements.Common_Behavior.Instance.classifier*,
Behavioral_Elements.Common_Behavior.Instance.attributeLink*,
Behavioral_Elements.Common_Behavior.Instance.linkEnd*,
Behavioral_Elements.Common_Behavior.Instance.stimulus1*,
Behavioral_Elements.Common_Behavior.Instance.stimulus3*,
Behavioral_Elements.Common_Behavior.Instance.componentInstance?,
Behavioral_Elements.Common_Behavior.Instance.stimulus2*,
Behavioral_Elements.Common_Behavior.NodeInstance.resident*,
Foundation.Core.ModelElement.templateParameter*,
Foundation.Core.ModelElement.taggedValue*,
Behavioral_Elements.Common_Behavior.Instance.slot*)?
>

<!ATTLIST Behavioral_Elements.Common_Behavior.NodeInstance
    %XMI.element.att;
    %XMI.link.att;
>

<!ELEMENT Behavioral_Elements.Common_Behavior ((Behavioral_Elements.Common_Behavior.Instance |
Behavioral_Elements.Common_Behavior.Signal |
Behavioral_Elements.Common_Behavior.CreateAction |
Behavioral_Elements.Common_Behavior.DestroyAction |
Behavioral_Elements.Common_Behavior.UninterpretedAction |
Behavioral_Elements.Common_Behavior.Action |
Behavioral_Elements.Common_Behavior.AttributeLink |
Behavioral_Elements.Common_Behavior.LinkObject |
Behavioral_Elements.Common_Behavior.Object |
Behavioral_Elements.Common_Behavior.DataValue |
Behavioral_Elements.Common_Behavior.CallAction |
Behavioral_Elements.Common_Behavior.SendAction |
Behavioral_Elements.Common_Behavior.ActionSequence |
Behavioral_Elements.Common_Behavior.Argument |
Behavioral_Elements.Common_Behavior.Reception |
Behavioral_Elements.Common_Behavior.Link |
Behavioral_Elements.Common_Behavior.LinkEnd |
Behavioral_Elements.Common_Behavior.ReturnAction |
Behavioral_Elements.Common_Behavior.TerminateAction |
Behavioral_Elements.Common_Behavior.Stimulus |
Behavioral_Elements.Common_Behavior.Exception |
Behavioral_Elements.Common_Behavior.ComponentInstance |
Behavioral_Elements.Common_Behavior.NodeInstance)*
>

<!ATTLIST Behavioral_Elements.Common_Behavior
    %XMI.element.att;
    %XMI.link.att;
```

```

>

<!-- _____ -->
<!-- _____ -->
<!-- METAMODEL PACKAGE: Use_Cases -->
<!-- _____ -->

<!-- _____ -->
<!-- _____ -->
<!-- METAMODEL CLASS: UseCase -->
<!-- _____ -->

<!ELEMENT Behavioral_Elements.Use_Cases.UseCase.extend2
                (Behavioral_Elements.Use_Cases.Extend)* >

<!ELEMENT Behavioral_Elements.Use_Cases.UseCase.extend
                (Behavioral_Elements.Use_Cases.Extend)* >

<!ELEMENT Behavioral_Elements.Use_Cases.UseCase.include
                (Behavioral_Elements.Use_Cases.Include)* >

<!ELEMENT Behavioral_Elements.Use_Cases.UseCase.include2
                (Behavioral_Elements.Use_Cases.Include)* >

<!ELEMENT Behavioral_Elements.Use_Cases.UseCase.extensionPoint
                (Behavioral_Elements.Use_Cases.ExtensionPoint)* >

<!ELEMENT Behavioral_Elements.Use_Cases.UseCase (Foundation.Core.ModelElement.name?,
        Foundation.Core.ModelElement.visibility?,
        Foundation.Core.ModelElement.isSpecification?,
        Foundation.Core.GeneralizableElement.isRoot?,
        Foundation.Core.GeneralizableElement.isLeaf?,
        Foundation.Core.GeneralizableElement.isAbstract?,
        XMI.extension*,
        Foundation.Core.ModelElement.namespace?,
        Foundation.Core.ModelElement.clientDependency*,
        Foundation.Core.ModelElement.constraint*,
        Foundation.Core.ModelElement.supplierDependency*,
        Foundation.Core.ModelElement.presentation*,
        Foundation.Core.ModelElement.targetFlow*,
        Foundation.Core.ModelElement.sourceFlow*,
        Foundation.Core.ModelElement.templateParameter3*,
        Foundation.Core.ModelElement.binding?,
        Foundation.Core.ModelElement.comment*,
        Foundation.Core.ModelElement.elementResidence*,
        Foundation.Core.ModelElement.templateParameter2*,
        Foundation.Core.ModelElement.stereotype?,
        Foundation.Core.ModelElement.behavior*,
        Foundation.Core.ModelElement.classifierRole*,
        Foundation.Core.ModelElement.collaboration*,
        Foundation.Core.ModelElement.partition*,
        Foundation.Core.ModelElement.elementImport*,
        Foundation.Core.GeneralizableElement.generalization*,
        Foundation.Core.GeneralizableElement.specialization*,
        Foundation.Core.Classifier.participant*,
        Foundation.Core.Classifier.powerTypeRange*,
        Foundation.Core.Classifier.instance*,
        Foundation.Core.Classifier.createAction*,
        Foundation.Core.Classifier.classifierRole*,
        Foundation.Core.Classifier.collaboration*,
        Foundation.Core.Classifier.classifierInState*,
        Foundation.Core.Classifier.objectFlowState*,
        Behavioral_Elements.Use_Cases.UseCase.extend2*,
        Behavioral_Elements.Use_Cases.UseCase.extend*,
        Behavioral_Elements.Use_Cases.UseCase.include*,
        Behavioral_Elements.Use_Cases.UseCase.include2*,

```

6 UML XMI DTD Specification

```
Behavioral_Elements.Use_Cases.UseCase.extensionPoint*,
Foundation.Core.ModelElement.templateParameter*,
Foundation.Core.ModelElement.taggedValue*,
Foundation.Core.Namespace.ownedElement*,
Foundation.Core.Classifier.feature*)?
>

<!-- Behavioral_Elements.Use_Cases.UseCase
      %XMI.element.att;
      %XMI.link.att;
-->

<!-- METAMODEL CLASS: Actor
-->

<ELEMENT Behavioral_Elements.Use_Cases.Actor (
Foundation.Core.ModelElement.name?,
Foundation.Core.ModelElement.visibility?,
Foundation.Core.ModelElement.isSpecification?,
Foundation.Core.GeneralizableElement.isRoot?,
Foundation.Core.GeneralizableElement.isLeaf?,
Foundation.Core.GeneralizableElement.isAbstract?,
XMI.extension*,
Foundation.Core.ModelElement.namespace?,
Foundation.Core.ModelElement.clientDependency*,
Foundation.Core.ModelElement.constraint*,
Foundation.Core.ModelElement.supplierDependency*,
Foundation.Core.ModelElement.presentation*,
Foundation.Core.ModelElement.targetFlow*,
Foundation.Core.ModelElement.sourceFlow*,
Foundation.Core.ModelElement.templateParameter3*,
Foundation.Core.ModelElement.binding?,
Foundation.Core.ModelElement.comment*,
Foundation.Core.ModelElement.elementResidence*,
Foundation.Core.ModelElement.templateParameter2*,
Foundation.Core.ModelElement.stereotype?,
Foundation.Core.ModelElement.behavior*,
Foundation.Core.ModelElement.classifierRole*,
Foundation.Core.ModelElement.collaboration*,
Foundation.Core.ModelElement.partition*,
Foundation.Core.ModelElement.elementImport*,
Foundation.Core.GeneralizableElement.generalization*,
Foundation.Core.GeneralizableElement.specialization*,
Foundation.Core.Classifier.participant*,
Foundation.Core.Classifier.powersTypeRange*,
Foundation.Core.Classifier.instance*,
Foundation.Core.Classifier.createAction*,
Foundation.Core.Classifier.classifierRole*,
Foundation.Core.Classifier.collaboration*,
Foundation.Core.Classifier.classifierInState*,
Foundation.Core.Classifier.objectFlowState*,
Foundation.Core.ModelElement.templateParameter*,
Foundation.Core.ModelElement.taggedValue*,
Foundation.Core.Namespace.ownedElement*,
Foundation.Core.Classifier.feature*)?
-->

<!-- Behavioral_Elements.Use_Cases.Actor
      %XMI.element.att;
      %XMI.link.att;
-->

<!-- METAMODEL CLASS: UseCaseInstance
-->
```

```

<!ELEMENT Behavioral_Elements.Use_Cases.UseCaseInstance (
    Foundation.Core.ModelElement.name?,
    Foundation.Core.ModelElement.visibility?,
    Foundation.Core.ModelElement.isSpecification?,
    XMI.extension*,
    Foundation.Core.ModelElement.namespace?,
    Foundation.Core.ModelElement.clientDependency*,
    Foundation.Core.ModelElement.constraint*,
    Foundation.Core.ModelElement.supplierDependency*,
    Foundation.Core.ModelElement.presentation*,
    Foundation.Core.ModelElement.targetFlow*,
    Foundation.Core.ModelElement.sourceFlow*,
    Foundation.Core.ModelElement.templateParameter3*,
    Foundation.Core.ModelElement.binding?,
    Foundation.Core.ModelElement.comment*,
    Foundation.Core.ModelElement.elementResidence*,
    Foundation.Core.ModelElement.templateParameter2*,
    Foundation.Core.ModelElement.stereotype?,
    Foundation.Core.ModelElement.behavior*,
    Foundation.Core.ModelElement.classifierRole*,
    Foundation.Core.ModelElement.collaboration*,
    Foundation.Core.ModelElement.partition*,
    Foundation.Core.ModelElement.elementImport*,
    Behavioral_Elements.Common_Behavior.Instance.classifier*,
    Behavioral_Elements.Common_Behavior.Instance.attributeLink*,
    Behavioral_Elements.Common_Behavior.Instance.linkEnd*,
    Behavioral_Elements.Common_Behavior.Instance.stimulus1*,
    Behavioral_Elements.Common_Behavior.Instance.stimulus3*,
    Behavioral_Elements.Common_Behavior.Instance.componentInstance?,
    Behavioral_Elements.Common_Behavior.Instance.stimulus2*,
    Foundation.Core.ModelElement.templateParameter*,
    Foundation.Core.ModelElement.taggedValue*,
    Behavioral_Elements.Common_Behavior.Instance.slot*)?
>

<!ATTLIST Behavioral_Elements.Use_Cases.UseCaseInstance
    %XMI.element.att;
    %XMI.link.att;
>

<!-- _____ -->
<!-- _____ -->
<!-- METAMODEL CLASS: Extend -->
<!-- _____ -->

<!ELEMENT Behavioral_Elements.Use_Cases.Extend.condition
    (Foundation.Data_Types.BooleanExpression) >

<!ELEMENT Behavioral_Elements.Use_Cases.Extend.base
    (Behavioral_Elements.Use_Cases.UseCase)? >

<!ELEMENT Behavioral_Elements.Use_Cases.Extend.extension
    (Behavioral_Elements.Use_Cases.UseCase)? >

<!ELEMENT Behavioral_Elements.Use_Cases.Extend.extensionPoint
    (Behavioral_Elements.Use_Cases.ExtensionPoint)* >

<!ELEMENT Behavioral_Elements.Use_Cases.Extend (
    Foundation.Core.ModelElement.name?,
    Foundation.Core.ModelElement.visibility?,
    Foundation.Core.ModelElement.isSpecification?,
    Behavioral_Elements.Use_Cases.Extend.condition?,
    XMI.extension*,
    Foundation.Core.ModelElement.namespace?,
    Foundation.Core.ModelElement.clientDependency*,
    Foundation.Core.ModelElement.constraint*,
    Foundation.Core.ModelElement.supplierDependency*,
    Foundation.Core.ModelElement.presentation*,
    Foundation.Core.ModelElement.targetFlow*,
    Foundation.Core.ModelElement.sourceFlow*,

```

6 UML XMI DTD Specification

```
Foundation.Core.ModelElement.templateParameter3*,
Foundation.Core.ModelElement.binding?,
Foundation.Core.ModelElement.comment*,
Foundation.Core.ModelElement.elementResidence*,
Foundation.Core.ModelElement.templateParameter2*,
Foundation.Core.ModelElement.stereotype?,
Foundation.Core.ModelElement.behavior*,
Foundation.Core.ModelElement.classifierRole*,
Foundation.Core.ModelElement.collaboration*,
Foundation.Core.ModelElement.partition*,
Foundation.Core.ModelElement.elementImport*,
Behavioral_Elements.Use_Cases.Extend.base?,
Behavioral_Elements.Use_Cases.Extend.extension?,
Behavioral_Elements.Use_Cases.Extend.extensionPoint*,
Foundation.Core.ModelElement.templateParameter*,
Foundation.Core.ModelElement.taggedValue*)?
>
<!-- Behavioral_Elements.Use_Cases.Extend
      %XMI.element.att;
      %XMI.link.att;
-->
<!-- ----- -->
<!-- ----- -->
<!-- METAMODEL CLASS: Include ----- -->
<!-- ----- -->

<!-- Behavioral_Elements.Use_Cases.Include.addition
      (Behavioral_Elements.Use_Cases.UseCase)? >

<!-- Behavioral_Elements.Use_Cases.Include.base
      (Behavioral_Elements.Use_Cases.UseCase)? >

<!-- Behavioral_Elements.Use_Cases.Include
      (Foundation.Core.ModelElement.name?,
      Foundation.Core.ModelElement.visibility?,
      Foundation.Core.ModelElement.isSpecification?,
      XMI.extension*,
      Foundation.Core.ModelElement.namespace?,
      Foundation.Core.ModelElement.clientDependency*,
      Foundation.Core.ModelElement.constraint*,
      Foundation.Core.ModelElement.supplierDependency*,
      Foundation.Core.ModelElement.presentation*,
      Foundation.Core.ModelElement.targetFlow*,
      Foundation.Core.ModelElement.sourceFlow*,
      Foundation.Core.ModelElement.templateParameter3*,
      Foundation.Core.ModelElement.binding?,
      Foundation.Core.ModelElement.comment*,
      Foundation.Core.ModelElement.elementResidence*,
      Foundation.Core.ModelElement.templateParameter2*,
      Foundation.Core.ModelElement.stereotype?,
      Foundation.Core.ModelElement.behavior*,
      Foundation.Core.ModelElement.classifierRole*,
      Foundation.Core.ModelElement.collaboration*,
      Foundation.Core.ModelElement.partition*,
      Foundation.Core.ModelElement.elementImport*,
      Behavioral_Elements.Use_Cases.Include.addition?,
      Behavioral_Elements.Use_Cases.Include.base?,
      Foundation.Core.ModelElement.templateParameter*,
      Foundation.Core.ModelElement.taggedValue*)?
-->
<!-- Behavioral_Elements.Use_Cases.Include
      %XMI.element.att;
      %XMI.link.att;
-->
<!-- ----- -->
<!-- ----- -->
```

6.3 UML XMI DTD

```
<!-- METAMODEL CLASS: ExtensionPoint -->
<!-- ----- -->

<!ELEMENT Behavioral_Elements.Use_Cases.ExtensionPoint.location (#PCDATA |
                                                                XMI.reference)*
                                                                >

<!ELEMENT Behavioral_Elements.Use_Cases.ExtensionPoint.useCase
                                                                (Behavioral_Elements.Use_Cases.UseCase)? >

<!ELEMENT Behavioral_Elements.Use_Cases.ExtensionPoint.extend
                                                                (Behavioral_Elements.Use_Cases.Extend)* >

<!ELEMENT Behavioral_Elements.Use_Cases.ExtensionPoint (Foundation.Core.ModelElement.name?,
                                                                Foundation.Core.ModelElement.visibility?,
                                                                Foundation.Core.ModelElement.isSpecification?,
                                                                Behavioral_Elements.Use_Cases.ExtensionPoint.location?,
                                                                XMI.extension*,
                                                                Foundation.Core.ModelElement.namespace?,
                                                                Foundation.Core.ModelElement.clientDependency*,
                                                                Foundation.Core.ModelElement.constraint*,
                                                                Foundation.Core.ModelElement.supplierDependency*,
                                                                Foundation.Core.ModelElement.presentation*,
                                                                Foundation.Core.ModelElement.targetFlow*,
                                                                Foundation.Core.ModelElement.sourceFlow*,
                                                                Foundation.Core.ModelElement.templateParameter3*,
                                                                Foundation.Core.ModelElement.binding?,
                                                                Foundation.Core.ModelElement.comment*,
                                                                Foundation.Core.ModelElement.elementResidence*,
                                                                Foundation.Core.ModelElement.templateParameter2*,
                                                                Foundation.Core.ModelElement.stereotype?,
                                                                Foundation.Core.ModelElement.behavior*,
                                                                Foundation.Core.ModelElement.classifierRole*,
                                                                Foundation.Core.ModelElement.collaboration*,
                                                                Foundation.Core.ModelElement.partition*,
                                                                Foundation.Core.ModelElement.elementImport*,
                                                                Behavioral_Elements.Use_Cases.ExtensionPoint.useCase?,
                                                                Behavioral_Elements.Use_Cases.ExtensionPoint.extend*,
                                                                Foundation.Core.ModelElement.templateParameter*,
                                                                Foundation.Core.ModelElement.taggedValue*)?
                                                                >

<!ATTLIST Behavioral_Elements.Use_Cases.ExtensionPoint
                                                                %XMI.element.att;
                                                                %XMI.link.att;
>

<!ELEMENT Behavioral_Elements.Use_Cases ((Behavioral_Elements.Use_Cases.UseCase |
                                                                Behavioral_Elements.Use_Cases.Actor |
                                                                Behavioral_Elements.Use_Cases.UseCaseInstance |
                                                                Behavioral_Elements.Use_Cases.Extend |
                                                                Behavioral_Elements.Use_Cases.Include |
                                                                Behavioral_Elements.Use_Cases.ExtensionPoint)*)
                                                                >

<!ATTLIST Behavioral_Elements.Use_Cases
                                                                %XMI.element.att;
                                                                %XMI.link.att;
>

<!-- ----- -->
<!-- ----- -->
<!-- METAMODEL PACKAGE: State_Machines -->
<!-- ----- -->

<!ELEMENT Behavioral_Elements.State_Machines.State.entry (Behavioral_Elements.Common_Behavior.Action |
                                                                Behavioral_Elements.Common_Behavior.CallAction |
                                                                Behavioral_Elements.Common_Behavior.SendAction |
```

6 UML XMI DTD Specification

```
Behavioral_Elements.Common_Behavior.ActionSequence |
Behavioral_Elements.Common_Behavior.ReturnAction |
Behavioral_Elements.Common_Behavior.TerminateAction |
Behavioral_Elements.Common_Behavior.DestroyAction |
Behavioral_Elements.Common_Behavior.CreateAction |
Behavioral_Elements.Common_Behavior.UninterpretedAction)?
>

<!ELEMENT Behavioral_Elements.State_Machines.State.exit (Behavioral_Elements.Common_Behavior.Action |
Behavioral_Elements.Common_Behavior.CallAction |
Behavioral_Elements.Common_Behavior.SendAction |
Behavioral_Elements.Common_Behavior.ActionSequence |
Behavioral_Elements.Common_Behavior.ReturnAction |
Behavioral_Elements.Common_Behavior.TerminateAction |
Behavioral_Elements.Common_Behavior.DestroyAction |
Behavioral_Elements.Common_Behavior.CreateAction |
Behavioral_Elements.Common_Behavior.UninterpretedAction)?
>

<!ELEMENT Behavioral_Elements.State_Machines.Event.parameter
(Foundation.Core.Parameter)* >

<!ELEMENT Behavioral_Elements.State_Machines.Transition.guard
(Behavioral_Elements.State_Machines.Guard)? >

<!ELEMENT Behavioral_Elements.State_Machines.StateMachine.top (Behavioral_Elements.State_Machines.State |
Behavioral_Elements.State_Machines.CompositeState |
Behavioral_Elements.State_Machines.SubmachineState |
Behavioral_Elements.Activity_Graphs.SubactivityState |
Behavioral_Elements.State_Machines.SimpleState |
Behavioral_Elements.Activity_Graphs.ObjectFlowState |
Behavioral_Elements.Activity_Graphs.ActionState |
Behavioral_Elements.Activity_Graphs.CallState |
Behavioral_Elements.State_Machines.FinalState)?
>

<!ELEMENT Behavioral_Elements.State_Machines.CompositeState.subvertex (Behavioral_Elements.State_Machines.StateVertex |
Behavioral_Elements.State_Machines.Pseudostate |
Behavioral_Elements.State_Machines.SynchState |
Behavioral_Elements.State_Machines.StubState |
Behavioral_Elements.State_Machines.State |
Behavioral_Elements.State_Machines.CompositeState |
Behavioral_Elements.State_Machines.SubmachineState |
Behavioral_Elements.Activity_Graphs.SubactivityState |
Behavioral_Elements.State_Machines.SimpleState |
Behavioral_Elements.Activity_Graphs.ObjectFlowState |
Behavioral_Elements.Activity_Graphs.ActionState |
Behavioral_Elements.Activity_Graphs.CallState |
Behavioral_Elements.State_Machines.FinalState)*
>

<!ELEMENT Behavioral_Elements.State_Machines.Transition.effect (Behavioral_Elements.Common_Behavior.Action |
Behavioral_Elements.Common_Behavior.CallAction |
Behavioral_Elements.Common_Behavior.SendAction |
Behavioral_Elements.Common_Behavior.ActionSequence |
Behavioral_Elements.Common_Behavior.ReturnAction |
Behavioral_Elements.Common_Behavior.TerminateAction |
Behavioral_Elements.Common_Behavior.DestroyAction |
Behavioral_Elements.Common_Behavior.CreateAction |
Behavioral_Elements.Common_Behavior.UninterpretedAction)?
>

<!ELEMENT Behavioral_Elements.State_Machines.State.internalTransition
(Behavioral_Elements.State_Machines.Transition)* >

<!ELEMENT Behavioral_Elements.State_Machines.StateMachine.transitions
(Behavioral_Elements.State_Machines.Transition)* >
```

6.3 UML XMI DTD

```
<!ELEMENT Behavioral_Elements.State_Machines.State.doActivity (Behavioral_Elements.Common_Behavior.Action |
Behavioral_Elements.Common_Behavior.CallAction |
Behavioral_Elements.Common_Behavior.SendAction |
Behavioral_Elements.Common_Behavior.ActionSequence |
Behavioral_Elements.Common_Behavior.ReturnAction |
Behavioral_Elements.Common_Behavior.TerminateAction |
Behavioral_Elements.Common_Behavior.DestroyAction |
Behavioral_Elements.Common_Behavior.CreateAction |
Behavioral_Elements.Common_Behavior.UninterpretedAction)?
>

<!-- _____ -->
<!-- -->
<!-- METAMODEL CLASS: StateMachine -->
<!-- _____ -->

<!ELEMENT Behavioral_Elements.State_Machines.StateMachine.context (Foundation.Core.ModelElement |
Foundation.Core.Comment |
Foundation.Core.Relationship |
Behavioral_Elements.Use_Cases.Extend |
Behavioral_Elements.Use_Cases.Include |
Foundation.Core.Generalization |
Foundation.Core.Flow |
Foundation.Core.Association |
Foundation.Core.AssociationClass |
Behavioral_Elements.Collaborations.AssociationRole |
Foundation.Core.Dependency |
Foundation.Core.Abstraction |
Foundation.Core.Usage |
Foundation.Core.Binding |
Foundation.Core.Permission |
Foundation.Extension_Mechanisms.TaggedValue |
Behavioral_Elements.Common_Behavior.Instance |
Behavioral_Elements.Common_Behavior.Object |
Behavioral_Elements.Common_Behavior.LinkObject |
Behavioral_Elements.Common_Behavior.DataValue |
Behavioral_Elements.Common_Behavior.ComponentInstance |
Behavioral_Elements.Common_Behavior.NodeInstance |
Behavioral_Elements.Use_Cases.UseCaseInstance |
Behavioral_Elements.Common_Behavior.Action |
Behavioral_Elements.Common_Behavior.CallAction |
Behavioral_Elements.Common_Behavior.SendAction |
Behavioral_Elements.Common_Behavior.ActionSequence |
Behavioral_Elements.Common_Behavior.ReturnAction |
Behavioral_Elements.Common_Behavior.TerminateAction |
Behavioral_Elements.Common_Behavior.DestroyAction |
Behavioral_Elements.Common_Behavior.CreateAction |
Behavioral_Elements.Common_Behavior.UninterpretedAction |
Behavioral_Elements.Common_Behavior.AttributeLink |
Behavioral_Elements.Common_Behavior.Argument |
Behavioral_Elements.Common_Behavior.Link |
Behavioral_Elements.Common_Behavior.LinkEnd |
Behavioral_Elements.Common_Behavior.Stimulus |
Behavioral_Elements.Use_Cases.ExtensionPoint |
Behavioral_Elements.State_Machines.StateMachine |
Behavioral_Elements.Activity_Graphs.ActivityGraph |
Behavioral_Elements.State_Machines.Event |
Behavioral_Elements.State_Machines.TimeEvent |
Behavioral_Elements.State_Machines.CallEvent |
Behavioral_Elements.State_Machines.SignalEvent |
Behavioral_Elements.State_Machines.ChangeEvent |
Behavioral_Elements.State_Machines.Transition |
Behavioral_Elements.State_Machines.StateVertex |
Behavioral_Elements.State_Machines.Pseudostate |
Behavioral_Elements.State_Machines.SynchState |
Behavioral_Elements.State_Machines.StubState |
Behavioral_Elements.State_Machines.State |
```

6 UML XMI DTD Specification

```
Behavioral_Elements.State_Machines.CompositeState |
Behavioral_Elements.State_Machines.SubmachineState |
Behavioral_Elements.Activity_Graphs.SubactivityState |
Behavioral_Elements.State_Machines.SimpleState |
Behavioral_Elements.Activity_Graphs.ObjectFlowState |
Behavioral_Elements.Activity_Graphs.ActionState |
Behavioral_Elements.Activity_Graphs.CallState |
Behavioral_Elements.State_Machines.FinalState |
Behavioral_Elements.State_Machines.Guard |
Behavioral_Elements.Collaborations.Message |
Behavioral_Elements.Collaborations.Interaction |
Behavioral_Elements.Activity_Graphs.Partition |
Foundation.Core.Feature |
Foundation.Core.BehavioralFeature |
Behavioral_Elements.Common_Behavior.Reception |
Foundation.Core.Operation |
Foundation.Core.Method |
Foundation.Core.StructuralFeature |
Foundation.Core.Attribute |
Foundation.Core.GeneralizableElement |
Foundation.Extension_Mechanisms.Stereotype |
Behavioral_Elements.Collaborations.Collaboration |
Model_Management.Package |
Model_Management.Subsystem |
Model_Management.Model |
Foundation.Core.Classifier |
Foundation.Core.Class |
Foundation.Core.DataType |
Foundation.Core.Interface |
Foundation.Core.Component |
Foundation.Core.Node |
Behavioral_Elements.Common_Behavior.Signal |
Behavioral_Elements.Common_Behavior.Exception |
Behavioral_Elements.Use_Cases.UseCase |
Behavioral_Elements.Use_Cases.Actor |
Behavioral_Elements.Collaborations.ClassifierRole |
Behavioral_Elements.Activity_Graphs.ClassifierInState |
Foundation.Core.AssociationEnd |
Behavioral_Elements.Collaborations.AssociationEndRole |
Foundation.Core.Namespace |
Foundation.Core.Parameter |
Foundation.Core.Constraint)?
>

<!ELEMENT Behavioral_Elements.State_Machines.StateMachine.subMachineState
(Behavioral_Elements.State_Machines.SubmachineState |
Behavioral_Elements.Activity_Graphs.SubactivityState)*
>

<!ELEMENT Behavioral_Elements.State_Machines.StateMachine (Foundation.Core.ModelElement.name?,
Foundation.Core.ModelElement.visibility?,
Foundation.Core.ModelElement.isSpecification?,
XMI.extension*,
Foundation.Core.ModelElement.namespace?,
Foundation.Core.ModelElement.clientDependency*,
Foundation.Core.ModelElement.constraint*,
Foundation.Core.ModelElement.supplierDependency*,
Foundation.Core.ModelElement.presentation*,
Foundation.Core.ModelElement.targetFlow*,
Foundation.Core.ModelElement.sourceFlow*,
Foundation.Core.ModelElement.templateParameter3*,
Foundation.Core.ModelElement.binding?,
Foundation.Core.ModelElement.comment*,
Foundation.Core.ModelElement.elementResidence*,
Foundation.Core.ModelElement.templateParameter2*,
Foundation.Core.ModelElement.stereotype?,
Foundation.Core.ModelElement.behavior*,
Foundation.Core.ModelElement.classifierRole*,
```

```

Foundation.Core.ModelElement.collaboration*,
Foundation.Core.ModelElement.partition*,
Foundation.Core.ModelElement.elementImport*,
Behavioral_Elements.State_Machines.StateMachine.context?,
Behavioral_Elements.State_Machines.StateMachine.subMachineState*,
Foundation.Core.ModelElement.templateParameter*,
Foundation.Core.ModelElement.taggedValue*,
Behavioral_Elements.State_Machines.StateMachine.top?,
Behavioral_Elements.State_Machines.StateMachine.transitions*)?
>
<!ATTLIST Behavioral_Elements.State_Machines.StateMachine
    %XMI.element.att;
    %XMI.link.att;
>
<!-- _____ -->
<!-- _____ -->
<!-- METAMODEL CLASS: Event _____ -->
<!-- _____ -->

<!ELEMENT Behavioral_Elements.State_Machines.Event.state (Behavioral_Elements.State_Machines.State |
    Behavioral_Elements.State_Machines.CompositeState |
    Behavioral_Elements.State_Machines.SubmachineState |
    Behavioral_Elements.Activity_Graphs.SubactivityState |
    Behavioral_Elements.State_Machines.SimpleState |
    Behavioral_Elements.Activity_Graphs.ObjectFlowState |
    Behavioral_Elements.Activity_Graphs.ActionState |
    Behavioral_Elements.Activity_Graphs.CallState |
    Behavioral_Elements.State_Machines.FinalState)*
>

<!ELEMENT Behavioral_Elements.State_Machines.Event.transition
    (Behavioral_Elements.State_Machines.Transition)* >

<!ELEMENT Behavioral_Elements.State_Machines.Event (Foundation.Core.ModelElement.name?,
    Foundation.Core.ModelElement.visibility?,
    Foundation.Core.ModelElement.isSpecification?,
    XMI.extension*,
    Foundation.Core.ModelElement.namespace?,
    Foundation.Core.ModelElement.clientDependency*,
    Foundation.Core.ModelElement.constraint*,
    Foundation.Core.ModelElement.supplierDependency*,
    Foundation.Core.ModelElement.presentation*,
    Foundation.Core.ModelElement.targetFlow*,
    Foundation.Core.ModelElement.sourceFlow*,
    Foundation.Core.ModelElement.templateParameter3*,
    Foundation.Core.ModelElement.binding?,
    Foundation.Core.ModelElement.comment*,
    Foundation.Core.ModelElement.elementResidence*,
    Foundation.Core.ModelElement.templateParameter2*,
    Foundation.Core.ModelElement.stereotype?,
    Foundation.Core.ModelElement.behavior*,
    Foundation.Core.ModelElement.classifierRole*,
    Foundation.Core.ModelElement.collaboration*,
    Foundation.Core.ModelElement.partition*,
    Foundation.Core.ModelElement.elementImport*,
    Behavioral_Elements.State_Machines.Event.state*,
    Behavioral_Elements.State_Machines.Event.transition*,
    Foundation.Core.ModelElement.templateParameter*,
    Foundation.Core.ModelElement.taggedValue*,
    Behavioral_Elements.State_Machines.Event.parameter*)?
>
<!ATTLIST Behavioral_Elements.State_Machines.Event
    %XMI.element.att;
    %XMI.link.att;
>

```

6 UML XMI DTD Specification

```
<!-- _____ -->
<!-- _____ -->
<!-- METAMODEL CLASS: State -->
<!-- _____ -->

<!ELEMENT Behavioral_Elements.State_Machines.State.stateMachine (Behavioral_Elements.State_Machines.StateMachine |
                                                                    Behavioral_Elements.Activity_Graphs.ActivityGraph)?
>

<!ELEMENT Behavioral_Elements.State_Machines.State.deferrableEvent (Behavioral_Elements.State_Machines.Event |
                                                                    Behavioral_Elements.State_Machines.TimeEvent |
                                                                    Behavioral_Elements.State_Machines.CallEvent |
                                                                    Behavioral_Elements.State_Machines.SignalEvent |
                                                                    Behavioral_Elements.State_Machines.ChangeEvent)*
>

<!ELEMENT Behavioral_Elements.State_Machines.State.classifierInState
                                                                    (Behavioral_Elements.Activity_Graphs.ClassifierInState)* >

<!ELEMENT Behavioral_Elements.State_Machines.State (Foundation.Core.ModelElement.name?,
                                                                    Foundation.Core.ModelElement.visibility?,
                                                                    Foundation.Core.ModelElement.isSpecification?,
                                                                    XMI.extension*,
                                                                    Foundation.Core.ModelElement.namespace?,
                                                                    Foundation.Core.ModelElement.clientDependency*,
                                                                    Foundation.Core.ModelElement.constraint*,
                                                                    Foundation.Core.ModelElement.supplierDependency*,
                                                                    Foundation.Core.ModelElement.presentation*,
                                                                    Foundation.Core.ModelElement.targetFlow*,
                                                                    Foundation.Core.ModelElement.sourceFlow*,
                                                                    Foundation.Core.ModelElement.templateParameter3*,
                                                                    Foundation.Core.ModelElement.binding?,
                                                                    Foundation.Core.ModelElement.comment*,
                                                                    Foundation.Core.ModelElement.elementResidence*,
                                                                    Foundation.Core.ModelElement.templateParameter2*,
                                                                    Foundation.Core.ModelElement.stereotype?,
                                                                    Foundation.Core.ModelElement.behavior*,
                                                                    Foundation.Core.ModelElement.classifierRole*,
                                                                    Foundation.Core.ModelElement.collaboration*,
                                                                    Foundation.Core.ModelElement.partition*,
                                                                    Foundation.Core.ModelElement.elementImport*,
                                                                    Behavioral_Elements.State_Machines.StateVertex.container?,
                                                                    Behavioral_Elements.State_Machines.StateVertex.outgoing*,
                                                                    Behavioral_Elements.State_Machines.StateVertex.incoming*,
                                                                    Behavioral_Elements.State_Machines.State.stateMachine?,
                                                                    Behavioral_Elements.State_Machines.State.deferrableEvent*,
                                                                    Behavioral_Elements.State_Machines.State.classifierInState*,
                                                                    Foundation.Core.ModelElement.templateParameter*,
                                                                    Foundation.Core.ModelElement.taggedValue*,
                                                                    Behavioral_Elements.State_Machines.State.entry?,
                                                                    Behavioral_Elements.State_Machines.State.exit?,
                                                                    Behavioral_Elements.State_Machines.State.internalTransition*,
                                                                    Behavioral_Elements.State_Machines.State.doActivity)?
>

<!ATTLIST Behavioral_Elements.State_Machines.State
                                                                    %XMI.element.att;
                                                                    %XMI.link.att;
>

<!-- _____ -->
<!-- _____ -->
<!-- METAMODEL CLASS: TimeEvent -->
<!-- _____ -->

<!ELEMENT Behavioral_Elements.State_Machines.TimeEvent.when
                                                                    (Foundation.Data_Types.TimeExpression) >
```

```

<!ELEMENT Behavioral_Elements.State_Machines.TimeEvent (Foundation.Core.ModelElement.name?,
Foundation.Core.ModelElement.visibility?,
Foundation.Core.ModelElement.isSpecification?,
Behavioral_Elements.State_Machines.TimeEvent.when?,
XMI.extension*,
Foundation.Core.ModelElement.namespace?,
Foundation.Core.ModelElement.clientDependency*,
Foundation.Core.ModelElement.constraint*,
Foundation.Core.ModelElement.supplierDependency*,
Foundation.Core.ModelElement.presentation*,
Foundation.Core.ModelElement.targetFlow*,
Foundation.Core.ModelElement.sourceFlow*,
Foundation.Core.ModelElement.templateParameter3*,
Foundation.Core.ModelElement.binding?,
Foundation.Core.ModelElement.comment*,
Foundation.Core.ModelElement.elementResidence*,
Foundation.Core.ModelElement.templateParameter2*,
Foundation.Core.ModelElement.stereotype?,
Foundation.Core.ModelElement.behavior*,
Foundation.Core.ModelElement.classifierRole*,
Foundation.Core.ModelElement.collaboration*,
Foundation.Core.ModelElement.partition*,
Foundation.Core.ModelElement.elementImport*,
Behavioral_Elements.State_Machines.Event.state*,
Behavioral_Elements.State_Machines.Event.transition*,
Foundation.Core.ModelElement.templateParameter*,
Foundation.Core.ModelElement.taggedValue*,
Behavioral_Elements.State_Machines.Event.parameter*)?
>

<!ATTLIST Behavioral_Elements.State_Machines.TimeEvent
    %XMI.element.att;
    %XMI.link.att;
>

<!-- _____ -->
<!-- -->
<!-- METAMODEL CLASS: CallEvent -->
<!-- _____ -->

<!ELEMENT Behavioral_Elements.State_Machines.CallEvent.operation
(Foundation.Core.Operation)? >

<!ELEMENT Behavioral_Elements.State_Machines.CallEvent (Foundation.Core.ModelElement.name?,
Foundation.Core.ModelElement.visibility?,
Foundation.Core.ModelElement.isSpecification?,
XMI.extension*,
Foundation.Core.ModelElement.namespace?,
Foundation.Core.ModelElement.clientDependency*,
Foundation.Core.ModelElement.constraint*,
Foundation.Core.ModelElement.supplierDependency*,
Foundation.Core.ModelElement.presentation*,
Foundation.Core.ModelElement.targetFlow*,
Foundation.Core.ModelElement.sourceFlow*,
Foundation.Core.ModelElement.templateParameter3*,
Foundation.Core.ModelElement.binding?,
Foundation.Core.ModelElement.comment*,
Foundation.Core.ModelElement.elementResidence*,
Foundation.Core.ModelElement.templateParameter2*,
Foundation.Core.ModelElement.stereotype?,
Foundation.Core.ModelElement.behavior*,
Foundation.Core.ModelElement.classifierRole*,
Foundation.Core.ModelElement.collaboration*,
Foundation.Core.ModelElement.partition*,
Foundation.Core.ModelElement.elementImport*,
Behavioral_Elements.State_Machines.Event.state*,
Behavioral_Elements.State_Machines.Event.transition*,

```

6 UML XMI DTD Specification

```
Behavioral_Elements.State_Machines.CallEvent.operation?,
Foundation.Core.ModelElement.templateParameter*,
Foundation.Core.ModelElement.taggedValue*,
Behavioral_Elements.State_Machines.Event.parameter*)?
>
<!ATTLIST Behavioral_Elements.State_Machines.CallEvent
    %XMI.element.att;
    %XMI.link.att;
>

<!-- _____ -->
<!-- _____ -->
<!-- METAMODEL CLASS: SignalEvent -->
<!-- _____ -->

<!ELEMENT Behavioral_Elements.State_Machines.SignalEvent.signal (Behavioral_Elements.Common_Behavior.Signal |
    Behavioral_Elements.Common_Behavior.Exception)?
>

<!ELEMENT Behavioral_Elements.State_Machines.SignalEvent (Foundation.Core.ModelElement.name?,
    Foundation.Core.ModelElement.visibility?,
    Foundation.Core.ModelElement.isSpecification?,
    XMI.extension*,
    Foundation.Core.ModelElement.namespace?,
    Foundation.Core.ModelElement.clientDependency*,
    Foundation.Core.ModelElement.constraint*,
    Foundation.Core.ModelElement.supplierDependency*,
    Foundation.Core.ModelElement.presentation*,
    Foundation.Core.ModelElement.targetFlow*,
    Foundation.Core.ModelElement.sourceFlow*,
    Foundation.Core.ModelElement.templateParameter3*,
    Foundation.Core.ModelElement.binding?,
    Foundation.Core.ModelElement.comment*,
    Foundation.Core.ModelElement.elementResidence*,
    Foundation.Core.ModelElement.templateParameter2*,
    Foundation.Core.ModelElement.stereotype?,
    Foundation.Core.ModelElement.behavior*,
    Foundation.Core.ModelElement.classifierRole*,
    Foundation.Core.ModelElement.collaboration*,
    Foundation.Core.ModelElement.partition*,
    Foundation.Core.ModelElement.elementImport*,
    Behavioral_Elements.State_Machines.Event.state*,
    Behavioral_Elements.State_Machines.Event.transition*,
    Behavioral_Elements.State_Machines.SignalEvent.signal?,
    Foundation.Core.ModelElement.templateParameter*,
    Foundation.Core.ModelElement.taggedValue*,
    Behavioral_Elements.State_Machines.Event.parameter*)?
>

<!ATTLIST Behavioral_Elements.State_Machines.SignalEvent
    %XMI.element.att;
    %XMI.link.att;
>

<!-- _____ -->
<!-- _____ -->
<!-- METAMODEL CLASS: Transition -->
<!-- _____ -->

<!ELEMENT Behavioral_Elements.State_Machines.Transition.state (Behavioral_Elements.State_Machines.State |
    Behavioral_Elements.State_Machines.CompositeState |
    Behavioral_Elements.State_Machines.SubmachineState |
    Behavioral_Elements.Activity_Graphs.SubactivityState |
    Behavioral_Elements.State_Machines.SimpleState |
    Behavioral_Elements.Activity_Graphs.ObjectFlowState |
    Behavioral_Elements.Activity_Graphs.ActionState |
    Behavioral_Elements.Activity_Graphs.CallState |
```



```

Behavioral_Elements.State_Machines.FinalState)?
>

<!ELEMENT Behavioral_Elements.State_Machines.Transition.trigger (Behavioral_Elements.State_Machines.Event |
    Behavioral_Elements.State_Machines.TimeEvent |
    Behavioral_Elements.State_Machines.CallEvent |
    Behavioral_Elements.State_Machines.SignalEvent |
    Behavioral_Elements.State_Machines.ChangeEvent)?
>

<!ELEMENT Behavioral_Elements.State_Machines.Transition.stateMachine (Behavioral_Elements.State_Machines.StateMachine |
    Behavioral_Elements.Activity_Graphs.ActivityGraph)?
>

<!ELEMENT Behavioral_Elements.State_Machines.Transition.source (Behavioral_Elements.State_Machines.StateVertex |
    Behavioral_Elements.State_Machines.Pseudostate |
    Behavioral_Elements.State_Machines.SynchState |
    Behavioral_Elements.State_Machines.StubState |
    Behavioral_Elements.State_Machines.State |
    Behavioral_Elements.State_Machines.CompositeState |
    Behavioral_Elements.State_Machines.SubmachineState |
    Behavioral_Elements.Activity_Graphs.SubactivityState |
    Behavioral_Elements.State_Machines.SimpleState |
    Behavioral_Elements.Activity_Graphs.ObjectFlowState |
    Behavioral_Elements.Activity_Graphs.ActionState |
    Behavioral_Elements.Activity_Graphs.CallState |
    Behavioral_Elements.State_Machines.FinalState)?
>

<!ELEMENT Behavioral_Elements.State_Machines.Transition.target (Behavioral_Elements.State_Machines.StateVertex |
    Behavioral_Elements.State_Machines.Pseudostate |
    Behavioral_Elements.State_Machines.SynchState |
    Behavioral_Elements.State_Machines.StubState |
    Behavioral_Elements.State_Machines.State |
    Behavioral_Elements.State_Machines.CompositeState |
    Behavioral_Elements.State_Machines.SubmachineState |
    Behavioral_Elements.Activity_Graphs.SubactivityState |
    Behavioral_Elements.State_Machines.SimpleState |
    Behavioral_Elements.Activity_Graphs.ObjectFlowState |
    Behavioral_Elements.Activity_Graphs.ActionState |
    Behavioral_Elements.Activity_Graphs.CallState |
    Behavioral_Elements.State_Machines.FinalState)?
>

<!ELEMENT Behavioral_Elements.State_Machines.Transition (Foundation.Core.ModelElement.name?,
    Foundation.Core.ModelElement.visibility?,
    Foundation.Core.ModelElement.isSpecification?,
    XMI.extension*,
    Foundation.Core.ModelElement.namespace?,
    Foundation.Core.ModelElement.clientDependency*,
    Foundation.Core.ModelElement.constraint*,
    Foundation.Core.ModelElement.supplierDependency*,
    Foundation.Core.ModelElement.presentation*,
    Foundation.Core.ModelElement.targetFlow*,
    Foundation.Core.ModelElement.sourceFlow*,
    Foundation.Core.ModelElement.templateParameter3*,
    Foundation.Core.ModelElement.binding?,
    Foundation.Core.ModelElement.comment*,
    Foundation.Core.ModelElement.elementResidence*,
    Foundation.Core.ModelElement.templateParameter2*,
    Foundation.Core.ModelElement.stereotype?,
    Foundation.Core.ModelElement.behavior*,
    Foundation.Core.ModelElement.classifierRole*,
    Foundation.Core.ModelElement.collaboration*,
    Foundation.Core.ModelElement.partition*,
    Foundation.Core.ModelElement.elementImport*,
    Behavioral_Elements.State_Machines.Transition.state?,
    Behavioral_Elements.State_Machines.Transition.trigger?,

```

6 UML XMI DTD Specification

```
Behavioral_Elements.State_Machines.Transition.stateMachine?,
Behavioral_Elements.State_Machines.Transition.source?,
Behavioral_Elements.State_Machines.Transition.target?,
Foundation.Core.ModelElement.templateParameter*,
Foundation.Core.ModelElement.taggedValue*,
Behavioral_Elements.State_Machines.Transition.guard?,
Behavioral_Elements.State_Machines.Transition.effect?}?
>
<!-- Behavioral_Elements.State_Machines.Transition
      %XMI.element.att;
      %XMI.link.att;
-->
<!-- _____ -->
<!-- _____ -->
<!-- METAMODEL CLASS: StateVertex -->
<!-- _____ -->

<!-- Behavioral_Elements.State_Machines.StateVertex.container (Behavioral_Elements.State_Machines.CompositeState |
Behavioral_Elements.State_Machines.SubmachineState |
Behavioral_Elements.Activity_Graphs.SubactivityState)?
-->

<!-- Behavioral_Elements.State_Machines.StateVertex.outgoing
      (Behavioral_Elements.State_Machines.Transition)* -->

<!-- Behavioral_Elements.State_Machines.StateVertex.incoming
      (Behavioral_Elements.State_Machines.Transition)* -->

<!-- Behavioral_Elements.State_Machines.StateVertex (Foundation.Core.ModelElement.name?,
Foundation.Core.ModelElement.visibility?,
Foundation.Core.ModelElement.isSpecification?,
XMI.extension*,
Foundation.Core.ModelElement.namespace?,
Foundation.Core.ModelElement.clientDependency*,
Foundation.Core.ModelElement.constraint*,
Foundation.Core.ModelElement.supplierDependency*,
Foundation.Core.ModelElement.presentation*,
Foundation.Core.ModelElement.targetFlow*,
Foundation.Core.ModelElement.sourceFlow*,
Foundation.Core.ModelElement.templateParameter3*,
Foundation.Core.ModelElement.binding?,
Foundation.Core.ModelElement.comment*,
Foundation.Core.ModelElement.elementResidence*,
Foundation.Core.ModelElement.templateParameter2*,
Foundation.Core.ModelElement.stereotype?,
Foundation.Core.ModelElement.behavior*,
Foundation.Core.ModelElement.classifierRole*,
Foundation.Core.ModelElement.collaboration*,
Foundation.Core.ModelElement.partition*,
Foundation.Core.ModelElement.elementImport*,
Behavioral_Elements.State_Machines.StateVertex.container?,
Behavioral_Elements.State_Machines.StateVertex.outgoing*,
Behavioral_Elements.State_Machines.StateVertex.incoming*,
Foundation.Core.ModelElement.templateParameter*,
Foundation.Core.ModelElement.taggedValue*)?
-->

<!-- Behavioral_Elements.State_Machines.StateVertex
      %XMI.element.att;
      %XMI.link.att;
-->
<!-- _____ -->
<!-- _____ -->
<!-- METAMODEL CLASS: CompositeState -->
<!-- _____ -->
```

6.3 UML XMI DTD

```
<!ELEMENT Behavioral_Elements.State_Machines.CompositeState.isConcurrent
EMPTY >
<!ATTLIST Behavioral_Elements.State_Machines.CompositeState.isConcurrent
xmi.value ( true | false ) #REQUIRED
>
<!ELEMENT Behavioral_Elements.State_Machines.CompositeState (Foundation.Core.ModelElement.name?,
Foundation.Core.ModelElement.visibility?,
Foundation.Core.ModelElement.isSpecification?,
Behavioral_Elements.State_Machines.CompositeState.isConcurrent?,
XMI.extension*,
Foundation.Core.ModelElement.namespace?,
Foundation.Core.ModelElement.clientDependency*,
Foundation.Core.ModelElement.constraint*,
Foundation.Core.ModelElement.supplierDependency*,
Foundation.Core.ModelElement.presentation*,
Foundation.Core.ModelElement.targetFlow*,
Foundation.Core.ModelElement.sourceFlow*,
Foundation.Core.ModelElement.templateParameter3*,
Foundation.Core.ModelElement.binding?,
Foundation.Core.ModelElement.comment*,
Foundation.Core.ModelElement.elementResidence*,
Foundation.Core.ModelElement.templateParameter2*,
Foundation.Core.ModelElement.stereotype?,
Foundation.Core.ModelElement.behavior*,
Foundation.Core.ModelElement.classifierRole*,
Foundation.Core.ModelElement.collaboration*,
Foundation.Core.ModelElement.partition*,
Foundation.Core.ModelElement.elementImport*,
Behavioral_Elements.State_Machines.StateVertex.container?,
Behavioral_Elements.State_Machines.StateVertex.outgoing*,
Behavioral_Elements.State_Machines.StateVertex.incoming*,
Behavioral_Elements.State_Machines.State.stateMachine?,
Behavioral_Elements.State_Machines.State.deferrableEvent*,
Behavioral_Elements.State_Machines.State.classifierInState*,
Foundation.Core.ModelElement.templateParameter*,
Foundation.Core.ModelElement.taggedValue*,
Behavioral_Elements.State_Machines.State.entry?,
Behavioral_Elements.State_Machines.State.exit?,
Behavioral_Elements.State_Machines.State.internalTransition*,
Behavioral_Elements.State_Machines.State.doActivity?,
Behavioral_Elements.State_Machines.CompositeState.subvertex*)?
>
<!ATTLIST Behavioral_Elements.State_Machines.CompositeState
%XMI.element.att;
%XMI.link.att;
>
<!-- _____ -->
<!-- _____ -->
<!-- METAMODEL CLASS: ChangeEvent -->
<!-- _____ -->
<!ELEMENT Behavioral_Elements.State_Machines.ChangeEvent.changeExpression
(Foundation.Data_Types.BooleanExpression) >
<!ELEMENT Behavioral_Elements.State_Machines.ChangeEvent (Foundation.Core.ModelElement.name?,
Foundation.Core.ModelElement.visibility?,
Foundation.Core.ModelElement.isSpecification?,
Behavioral_Elements.State_Machines.ChangeEvent.changeExpression?,
XMI.extension*,
Foundation.Core.ModelElement.namespace?,
Foundation.Core.ModelElement.clientDependency*,
Foundation.Core.ModelElement.constraint*,
Foundation.Core.ModelElement.supplierDependency*,
Foundation.Core.ModelElement.presentation*,
```

6 UML XMI DTD Specification

```
Foundation.Core.ModelElement.targetFlow*,
Foundation.Core.ModelElement.sourceFlow*,
Foundation.Core.ModelElement.templateParameter3*,
Foundation.Core.ModelElement.binding?,
Foundation.Core.ModelElement.comment*,
Foundation.Core.ModelElement.elementResidence*,
Foundation.Core.ModelElement.templateParameter2*,
Foundation.Core.ModelElement.stereotype?,
Foundation.Core.ModelElement.behavior*,
Foundation.Core.ModelElement.classifierRole*,
Foundation.Core.ModelElement.collaboration*,
Foundation.Core.ModelElement.partition*,
Foundation.Core.ModelElement.elementImport*,
Behavioral_Elements.State_Machines.Event.state*,
Behavioral_Elements.State_Machines.Event.transition*,
Foundation.Core.ModelElement.templateParameter*,
Foundation.Core.ModelElement.taggedValue*,
Behavioral_Elements.State_Machines.Event.parameter*)?
>

<!ATTLIST Behavioral_Elements.State_Machines.ChangeEvent
    %XMI.element.att;
    %XMI.link.att;
>

<!-- _____ -->
<!-- _____ -->
<!-- METAMODEL CLASS: Guard _____ -->
<!-- _____ -->

<!ELEMENT Behavioral_Elements.State_Machines.Guard.expression
    (Foundation.Data_Types.BooleanExpression) >

<!ELEMENT Behavioral_Elements.State_Machines.Guard.transition
    (Behavioral_Elements.State_Machines.Transition)? >

<!ELEMENT Behavioral_Elements.State_Machines.Guard (Foundation.Core.ModelElement.name?,
    Foundation.Core.ModelElement.visibility?,
    Foundation.Core.ModelElement.isSpecification?,
    Behavioral_Elements.State_Machines.Guard.expression?,
    XMI.extension*,
    Foundation.Core.ModelElement.namespace?,
    Foundation.Core.ModelElement.clientDependency*,
    Foundation.Core.ModelElement.constraint*,
    Foundation.Core.ModelElement.supplierDependency*,
    Foundation.Core.ModelElement.presentation*,
    Foundation.Core.ModelElement.targetFlow*,
    Foundation.Core.ModelElement.sourceFlow*,
    Foundation.Core.ModelElement.templateParameter3*,
    Foundation.Core.ModelElement.binding?,
    Foundation.Core.ModelElement.comment*,
    Foundation.Core.ModelElement.elementResidence*,
    Foundation.Core.ModelElement.templateParameter2*,
    Foundation.Core.ModelElement.stereotype?,
    Foundation.Core.ModelElement.behavior*,
    Foundation.Core.ModelElement.classifierRole*,
    Foundation.Core.ModelElement.collaboration*,
    Foundation.Core.ModelElement.partition*,
    Foundation.Core.ModelElement.elementImport*,
    Behavioral_Elements.State_Machines.Guard.transition?,
    Foundation.Core.ModelElement.templateParameter*,
    Foundation.Core.ModelElement.taggedValue*)?
>

<!ATTLIST Behavioral_Elements.State_Machines.Guard
    %XMI.element.att;
    %XMI.link.att;
>
```

```

<!-- _____ -->
<!-- -->
<!-- METAMODEL CLASS: Pseudostate -->
<!-- _____ -->

<!ELEMENT Behavioral_Elements.State_Machines.Pseudostate.kind EMPTY >
<!ATTLIST Behavioral_Elements.State_Machines.Pseudostate.kind
    xmi.value ( initial | deepHistory | shallowHistory | join | fork | branch | junction | final ) #REQUIRED
>

<!ELEMENT Behavioral_Elements.State_Machines.Pseudostate (Foundation.Core.ModelElement.name?,
    Foundation.Core.ModelElement.visibility?,
    Foundation.Core.ModelElement.isSpecification?,
    Behavioral_Elements.State_Machines.Pseudostate.kind?,
    XMI.extension*,
    Foundation.Core.ModelElement.namespace?,
    Foundation.Core.ModelElement.clientDependency*,
    Foundation.Core.ModelElement.constraint*,
    Foundation.Core.ModelElement.supplierDependency*,
    Foundation.Core.ModelElement.presentation*,
    Foundation.Core.ModelElement.targetFlow*,
    Foundation.Core.ModelElement.sourceFlow*,
    Foundation.Core.ModelElement.templateParameter3*,
    Foundation.Core.ModelElement.binding?,
    Foundation.Core.ModelElement.comment*,
    Foundation.Core.ModelElement.elementResidence*,
    Foundation.Core.ModelElement.templateParameter2*,
    Foundation.Core.ModelElement.stereotype?,
    Foundation.Core.ModelElement.behavior*,
    Foundation.Core.ModelElement.classifierRole*,
    Foundation.Core.ModelElement.collaboration*,
    Foundation.Core.ModelElement.partition*,
    Foundation.Core.ModelElement.elementImport*,
    Behavioral_Elements.State_Machines.StateVertex.container?,
    Behavioral_Elements.State_Machines.StateVertex.outgoing*,
    Behavioral_Elements.State_Machines.StateVertex.incoming*,
    Foundation.Core.ModelElement.templateParameter*,
    Foundation.Core.ModelElement.taggedValue*)?
>

<!ATTLIST Behavioral_Elements.State_Machines.Pseudostate
    %XMI.element.att;
    %XMI.link.att;
>

<!-- _____ -->
<!-- -->
<!-- METAMODEL CLASS: SimpleState -->
<!-- _____ -->

<!ELEMENT Behavioral_Elements.State_Machines.SimpleState (Foundation.Core.ModelElement.name?,
    Foundation.Core.ModelElement.visibility?,
    Foundation.Core.ModelElement.isSpecification?,
    XMI.extension*,
    Foundation.Core.ModelElement.namespace?,
    Foundation.Core.ModelElement.clientDependency*,
    Foundation.Core.ModelElement.constraint*,
    Foundation.Core.ModelElement.supplierDependency*,
    Foundation.Core.ModelElement.presentation*,
    Foundation.Core.ModelElement.targetFlow*,
    Foundation.Core.ModelElement.sourceFlow*,
    Foundation.Core.ModelElement.templateParameter3*,
    Foundation.Core.ModelElement.binding?,
    Foundation.Core.ModelElement.comment*,
    Foundation.Core.ModelElement.elementResidence*,
    Foundation.Core.ModelElement.templateParameter2*,
    Foundation.Core.ModelElement.stereotype?,

```

6.3 UML XMI DTD

```
Behavioral_Elements.State_Machines.State.internalTransition*,
Behavioral_Elements.State_Machines.State.doActivity?,
Behavioral_Elements.State_Machines.CompositeState.subvertex*)?
>
<!ATTLIST Behavioral_Elements.State_Machines.SubmachineState
    %XMI.element.att;
    %XMI.link.att;
>
<!-- _____ -->
<!-- _____ -->
<!-- METAMODEL CLASS:   SynchState _____ -->
<!-- _____ -->

<!ELEMENT Behavioral_Elements.State_Machines.SynchState.bound (#PCDATA |
    XMI.reference)*
>

<!ELEMENT Behavioral_Elements.State_Machines.SynchState (Foundation.Core.ModelElement.name?,
    Foundation.Core.ModelElement.visibility?,
    Foundation.Core.ModelElement.isSpecification?,
    Behavioral_Elements.State_Machines.SynchState.bound?,
    XMI.extension*,
    Foundation.Core.ModelElement.namespace?,
    Foundation.Core.ModelElement.clientDependency*,
    Foundation.Core.ModelElement.constraint*,
    Foundation.Core.ModelElement.supplierDependency*,
    Foundation.Core.ModelElement.presentation*,
    Foundation.Core.ModelElement.targetFlow*,
    Foundation.Core.ModelElement.sourceFlow*,
    Foundation.Core.ModelElement.templateParameter3*,
    Foundation.Core.ModelElement.binding?,
    Foundation.Core.ModelElement.comment*,
    Foundation.Core.ModelElement.elementResidence*,
    Foundation.Core.ModelElement.templateParameter2*,
    Foundation.Core.ModelElement.stereotype?,
    Foundation.Core.ModelElement.behavior*,
    Foundation.Core.ModelElement.classifierRole*,
    Foundation.Core.ModelElement.collaboration*,
    Foundation.Core.ModelElement.partition*,
    Foundation.Core.ModelElement.elementImport*,
    Behavioral_Elements.State_Machines.StateVertex.container?,
    Behavioral_Elements.State_Machines.StateVertex.outgoing*,
    Behavioral_Elements.State_Machines.StateVertex.incoming*,
    Foundation.Core.ModelElement.templateParameter*,
    Foundation.Core.ModelElement.taggedValue*)?
>

<!ATTLIST Behavioral_Elements.State_Machines.SynchState
    %XMI.element.att;
    %XMI.link.att;
>
<!-- _____ -->
<!-- _____ -->
<!-- METAMODEL CLASS:   StubState _____ -->
<!-- _____ -->

<!ELEMENT Behavioral_Elements.State_Machines.StubState.referenceState (#PCDATA |
    XMI.reference)*
>

<!ELEMENT Behavioral_Elements.State_Machines.StubState (Foundation.Core.ModelElement.name?,
    Foundation.Core.ModelElement.visibility?,
    Foundation.Core.ModelElement.isSpecification?,
    Behavioral_Elements.State_Machines.StubState.referenceState?,
    XMI.extension*,
```

6 UML XMI DTD Specification

```
Foundation.Core.ModelElement.namespace?,
Foundation.Core.ModelElement.clientDependency*,
Foundation.Core.ModelElement.constraint*,
Foundation.Core.ModelElement.supplierDependency*,
Foundation.Core.ModelElement.presentation*,
Foundation.Core.ModelElement.targetFlow*,
Foundation.Core.ModelElement.sourceFlow*,
Foundation.Core.ModelElement.templateParameter3*,
Foundation.Core.ModelElement.binding?,
Foundation.Core.ModelElement.comment*,
Foundation.Core.ModelElement.elementResidence*,
Foundation.Core.ModelElement.templateParameter2*,
Foundation.Core.ModelElement.stereotype?,
Foundation.Core.ModelElement.behavior*,
Foundation.Core.ModelElement.classifierRole*,
Foundation.Core.ModelElement.collaboration*,
Foundation.Core.ModelElement.partition*,
Foundation.Core.ModelElement.elementImport*,
Behavioral_Elements.State_Machines.StateVertex.container?,
Behavioral_Elements.State_Machines.StateVertex.outgoing*,
Behavioral_Elements.State_Machines.StateVertex.incoming*,
Foundation.Core.ModelElement.templateParameter*,
Foundation.Core.ModelElement.taggedValue*)?
>

<!ATTLIST Behavioral_Elements.State_Machines.StubState
    %XMI.element.att;
    %XMI.link.att;
>

<!-- _____ -->
<!-- _____ -->
<!-- METAMODEL CLASS: FinalState _____ -->
<!-- _____ -->

<!ELEMENT Behavioral_Elements.State_Machines.FinalState (Foundation.Core.ModelElement.name?,
Foundation.Core.ModelElement.visibility?,
Foundation.Core.ModelElement.isSpecification?,
XMI.extension*,
Foundation.Core.ModelElement.namespace?,
Foundation.Core.ModelElement.clientDependency*,
Foundation.Core.ModelElement.constraint*,
Foundation.Core.ModelElement.supplierDependency*,
Foundation.Core.ModelElement.presentation*,
Foundation.Core.ModelElement.targetFlow*,
Foundation.Core.ModelElement.sourceFlow*,
Foundation.Core.ModelElement.templateParameter3*,
Foundation.Core.ModelElement.binding?,
Foundation.Core.ModelElement.comment*,
Foundation.Core.ModelElement.elementResidence*,
Foundation.Core.ModelElement.templateParameter2*,
Foundation.Core.ModelElement.stereotype?,
Foundation.Core.ModelElement.behavior*,
Foundation.Core.ModelElement.classifierRole*,
Foundation.Core.ModelElement.collaboration*,
Foundation.Core.ModelElement.partition*,
Foundation.Core.ModelElement.elementImport*,
Behavioral_Elements.State_Machines.StateVertex.container?,
Behavioral_Elements.State_Machines.StateVertex.outgoing*,
Behavioral_Elements.State_Machines.StateVertex.incoming*,
Behavioral_Elements.State_Machines.State.stateMachine?,
Behavioral_Elements.State_Machines.State.deferrableEvent*,
Behavioral_Elements.State_Machines.State.classifierInState*,
Foundation.Core.ModelElement.templateParameter*,
Foundation.Core.ModelElement.taggedValue*,
Behavioral_Elements.State_Machines.State.entry?,
Behavioral_Elements.State_Machines.State.exit?,
Behavioral_Elements.State_Machines.State.internalTransition*,
```



```

Behavioral_Elements.State_Machines.State.doActivity?))?
>
<!ATTLIST Behavioral_Elements.State_Machines.FinalState
    %XMI.element.att;
    %XMI.link.att;
>

<!ELEMENT Behavioral_Elements.State_Machines ((Behavioral_Elements.State_Machines.StateMachine |
    Behavioral_Elements.State_Machines.Event |
    Behavioral_Elements.State_Machines.State |
    Behavioral_Elements.State_Machines.TimeEvent |
    Behavioral_Elements.State_Machines.CallEvent |
    Behavioral_Elements.State_Machines.SignalEvent |
    Behavioral_Elements.State_Machines.Transition |
    Behavioral_Elements.State_Machines.StateVertex |
    Behavioral_Elements.State_Machines.CompositeState |
    Behavioral_Elements.State_Machines.ChangeEvent |
    Behavioral_Elements.State_Machines.Guard |
    Behavioral_Elements.State_Machines.Pseudostate |
    Behavioral_Elements.State_Machines.SimpleState |
    Behavioral_Elements.State_Machines.SubmachineState |
    Behavioral_Elements.State_Machines.SynchState |
    Behavioral_Elements.State_Machines.StubState |
    Behavioral_Elements.State_Machines.FinalState)*)
>

<!ATTLIST Behavioral_Elements.State_Machines
    %XMI.element.att;
    %XMI.link.att;
>

<!-- _____ -->
<!-- _____ -->
<!-- METAMODEL PACKAGE: Collaborations -->
<!-- _____ -->

<!ELEMENT Behavioral_Elements.Collaborations.Interaction.message
    (Behavioral_Elements.Collaborations.Message)* >

<!ELEMENT Behavioral_Elements.Collaborations.Collaboration.interaction
    (Behavioral_Elements.Collaborations.Interaction)* >

<!-- _____ -->
<!-- _____ -->
<!-- METAMODEL CLASS: Collaboration -->
<!-- _____ -->

<!ELEMENT Behavioral_Elements.Collaborations.Collaboration.representedClassifier (Foundation.Core.Classifier |
    Foundation.Core.Class |
    Foundation.Core.AssociationClass |
    Foundation.Core.DataType |
    Foundation.Core.Interface |
    Foundation.Core.Component |
    Foundation.Core.Node |
    Behavioral_Elements.Common_Behavior.Signal |
    Behavioral_Elements.Common_Behavior.Exception |
    Behavioral_Elements.Use_Cases.UseCase |
    Behavioral_Elements.Use_Cases.Actor |
    Behavioral_Elements.Collaborations.ClassifierRole |
    Behavioral_Elements.Activity_Graphs.ClassifierInState |
    Model_Management.Subsystem)?
>

<!ELEMENT Behavioral_Elements.Collaborations.Collaboration.representedOperation
    (Foundation.Core.Operation)? >

<!ELEMENT Behavioral_Elements.Collaborations.Collaboration.constrainingElement (Foundation.Core.ModelElement |

```

6 UML XMI DTD Specification

```
Foundation.Core.Comment |
Foundation.Core.Relationship |
Behavioral_Elements.Use_Cases.Extend |
Behavioral_Elements.Use_Cases.Include |
Foundation.Core.Generalization |
Foundation.Core.Flow |
Foundation.Core.Association |
Foundation.Core.AssociationClass |
Behavioral_Elements.Collaborations.AssociationRole |
Foundation.Core.Dependency |
Foundation.Core.Abstraction |
Foundation.Core.Usage |
Foundation.Core.Binding |
Foundation.Core.Permission |
Foundation.Extension_Mechanisms.TaggedValue |
Behavioral_Elements.Common_Behavior.Instance |
Behavioral_Elements.Common_Behavior.Object |
Behavioral_Elements.Common_Behavior.LinkObject |
Behavioral_Elements.Common_Behavior.DataValue |
Behavioral_Elements.Common_Behavior.ComponentInstance |
Behavioral_Elements.Common_Behavior.NodeInstance |
Behavioral_Elements.Use_Cases.UseCaseInstance |
Behavioral_Elements.Common_Behavior.Action |
Behavioral_Elements.Common_Behavior.CallAction |
Behavioral_Elements.Common_Behavior.SendAction |
Behavioral_Elements.Common_Behavior.ActionSequence |
Behavioral_Elements.Common_Behavior.ReturnAction |
Behavioral_Elements.Common_Behavior.TerminateAction |
Behavioral_Elements.Common_Behavior.DestroyAction |
Behavioral_Elements.Common_Behavior.CreateAction |
Behavioral_Elements.Common_Behavior.UninterpretedAction |
Behavioral_Elements.Common_Behavior.AttributeLink |
Behavioral_Elements.Common_Behavior.Argument |
Behavioral_Elements.Common_Behavior.Link |
Behavioral_Elements.Common_Behavior.LinkEnd |
Behavioral_Elements.Common_Behavior.Stimulus |
Behavioral_Elements.Use_Cases.ExtensionPoint |
Behavioral_Elements.State_Machines.StateMachine |
Behavioral_Elements.Activity_Graphs.ActivityGraph |
Behavioral_Elements.State_Machines.Event |
Behavioral_Elements.State_Machines.TimeEvent |
Behavioral_Elements.State_Machines.CallEvent |
Behavioral_Elements.State_Machines.SignalEvent |
Behavioral_Elements.State_Machines.ChangeEvent |
Behavioral_Elements.State_Machines.Transition |
Behavioral_Elements.State_Machines.StateVertex |
Behavioral_Elements.State_Machines.Pseudostate |
Behavioral_Elements.State_Machines.SynchState |
Behavioral_Elements.State_Machines.StubState |
Behavioral_Elements.State_Machines.State |
Behavioral_Elements.State_Machines.CompositeState |
Behavioral_Elements.State_Machines.SubmachineState |
Behavioral_Elements.Activity_Graphs.SubactivityState |
Behavioral_Elements.State_Machines.SimpleState |
Behavioral_Elements.Activity_Graphs.ObjectFlowState |
Behavioral_Elements.Activity_Graphs.ActionState |
Behavioral_Elements.Activity_Graphs.CallState |
Behavioral_Elements.State_Machines.FinalState |
Behavioral_Elements.State_Machines.Guard |
Behavioral_Elements.Collaborations.Message |
Behavioral_Elements.Collaborations.Interaction |
Behavioral_Elements.Activity_Graphs.Partition |
Foundation.Core.Feature |
Foundation.Core.BehavioralFeature |
Behavioral_Elements.Common_Behavior.Reception |
Foundation.Core.Operation |
Foundation.Core.Method |
Foundation.Core.StructuralFeature |
```

6.3 UML XMI DTD

```
Foundation.Core.Attribute |
Foundation.Core.GeneralizableElement |
Foundation.Extension_Mechanisms.Stereotype |
Behavioral_Elements.Collaborations.Collaboration |
Model_Management.Package |
Model_Management.Subsystem |
Model_Management.Model |
Foundation.Core.Classifier |
Foundation.Core.Class |
Foundation.Core.DataType |
Foundation.Core.Interface |
Foundation.Core.Component |
Foundation.Core.Node |
Behavioral_Elements.Common_Behavior.Signal |
Behavioral_Elements.Common_Behavior.Exception |
Behavioral_Elements.Use_Cases.UseCase |
Behavioral_Elements.Use_Cases.Actor |
Behavioral_Elements.Collaborations.ClassifierRole |
Behavioral_Elements.Activity_Graphs.ClassifierInState |
Foundation.Core.AssociationEnd |
Behavioral_Elements.Collaborations.AssociationEndRole |
Foundation.Core.Namespace |
Foundation.Core.Parameter |
Foundation.Core.Constraint)*
>

<!ELEMENT Behavioral_Elements.Collaborations.Collaboration (Foundation.Core.ModelElement.name?,
Foundation.Core.ModelElement.visibility?,
Foundation.Core.ModelElement.isSpecification?,
Foundation.Core.GeneralizableElement.isRoot?,
Foundation.Core.GeneralizableElement.isLeaf?,
Foundation.Core.GeneralizableElement.isAbstract?,
XMI.extension*,
Foundation.Core.ModelElement.namespace?,
Foundation.Core.ModelElement.clientDependency*,
Foundation.Core.ModelElement.constraint*,
Foundation.Core.ModelElement.supplierDependency*,
Foundation.Core.ModelElement.presentation*,
Foundation.Core.ModelElement.targetFlow*,
Foundation.Core.ModelElement.sourceFlow*,
Foundation.Core.ModelElement.templateParameter3*,
Foundation.Core.ModelElement.binding?,
Foundation.Core.ModelElement.comment*,
Foundation.Core.ModelElement.elementResidence*,
Foundation.Core.ModelElement.templateParameter2*,
Foundation.Core.ModelElement.stereotype?,
Foundation.Core.ModelElement.behavior*,
Foundation.Core.ModelElement.classifierRole*,
Foundation.Core.ModelElement.collaboration*,
Foundation.Core.ModelElement.partition*,
Foundation.Core.ModelElement.elementImport*,
Foundation.Core.GeneralizableElement.generalization*,
Foundation.Core.GeneralizableElement.specialization*,
Behavioral_Elements.Collaborations.Collaboration.representedClassifier?,
Behavioral_Elements.Collaborations.Collaboration.representedOperation?,
Behavioral_Elements.Collaborations.Collaboration.constrainingElement*,
Foundation.Core.ModelElement.templateParameter*,
Foundation.Core.ModelElement.taggedValue*,
Foundation.Core.Namespace.ownedElement*,
Behavioral_Elements.Collaborations.Collaboration.interaction*)?
>

<!ATTLIST Behavioral_Elements.Collaborations.Collaboration
    %XMI.element.att;
    %XMI.link.att;
>

<!-- ----- -->
<!-- ----- -->
```

6 UML XMI DTD Specification

```
<!-- METAMODEL CLASS: ClassifierRole -->
<!-- ----- -->

<!ELEMENT Behavioral_Elements.Collaborations.ClassifierRole.multiplicity
        (Foundation.Data_Types.Multiplicity) >

<!ELEMENT Behavioral_Elements.Collaborations.ClassifierRole.base (Foundation.Core.Classifier |
        Foundation.Core.Class |
        Foundation.Core.AssociationClass |
        Foundation.Core.DataType |
        Foundation.Core.Interface |
        Foundation.Core.Component |
        Foundation.Core.Node |
        Behavioral_Elements.Common_Behavior.Signal |
        Behavioral_Elements.Common_Behavior.Exception |
        Behavioral_Elements.Use_Cases.UseCase |
        Behavioral_Elements.Use_Cases.Actor |
        Behavioral_Elements.Collaborations.ClassifierRole |
        Behavioral_Elements.Activity_Graphs.ClassifierInState |
        Model_Management.Subsystem)*
        >

<!ELEMENT Behavioral_Elements.Collaborations.ClassifierRole.associationEndRole
        (Behavioral_Elements.Collaborations.AssociationEndRole)* >

<!ELEMENT Behavioral_Elements.Collaborations.ClassifierRole.collaboration
        (Behavioral_Elements.Collaborations.Collaboration)? >

<!ELEMENT Behavioral_Elements.Collaborations.ClassifierRole.availableFeature (Foundation.Core.Feature |
        Foundation.Core.BehavioralFeature |
        Behavioral_Elements.Common_Behavior.Reception |
        Foundation.Core.Operation |
        Foundation.Core.Method |
        Foundation.Core.StructuralFeature |
        Foundation.Core.Attribute)*
        >

<!ELEMENT Behavioral_Elements.Collaborations.ClassifierRole.message2
        (Behavioral_Elements.Collaborations.Message)* >

<!ELEMENT Behavioral_Elements.Collaborations.ClassifierRole.message1
        (Behavioral_Elements.Collaborations.Message)* >

<!ELEMENT Behavioral_Elements.Collaborations.ClassifierRole.availableContents (Foundation.Core.ModelElement |
        Foundation.Core.Comment |
        Foundation.Core.Relationship |
        Behavioral_Elements.Use_Cases.Extend |
        Behavioral_Elements.Use_Cases.Include |
        Foundation.Core.Generalization |
        Foundation.Core.Flow |
        Foundation.Core.Association |
        Foundation.Core.AssociationClass |
        Behavioral_Elements.Collaborations.AssociationRole |
        Foundation.Core.Dependency |
        Foundation.Core.Abstraction |
        Foundation.Core.Usage |
        Foundation.Core.Binding |
        Foundation.Core.Permission |
        Foundation.Extension_Mechanisms.TaggedValue |
        Behavioral_Elements.Common_Behavior.Instance |
        Behavioral_Elements.Common_Behavior.Object |
        Behavioral_Elements.Common_Behavior.LinkObject |
        Behavioral_Elements.Common_Behavior.DataValue |
        Behavioral_Elements.Common_Behavior.ComponentInstance |
        Behavioral_Elements.Common_Behavior.NodeInstance |
        Behavioral_Elements.Use_Cases.UseCaseInstance |
        Behavioral_Elements.Common_Behavior.Action |
```

6.3 UML XMI DTD

```
Behavioral_Elements.Common_Behavior.CallAction |
Behavioral_Elements.Common_Behavior.SendAction |
Behavioral_Elements.Common_Behavior.ActionSequence |
Behavioral_Elements.Common_Behavior.ReturnAction |
Behavioral_Elements.Common_Behavior.TerminateAction |
Behavioral_Elements.Common_Behavior.DestroyAction |
Behavioral_Elements.Common_Behavior.CreateAction |
Behavioral_Elements.Common_Behavior.UninterpretedAction |
Behavioral_Elements.Common_Behavior.AttributeLink |
Behavioral_Elements.Common_Behavior.Argument |
Behavioral_Elements.Common_Behavior.Link |
Behavioral_Elements.Common_Behavior.LinkEnd |
Behavioral_Elements.Common_Behavior.Stimulus |
Behavioral_Elements.Use_Cases.ExtensionPoint |
Behavioral_Elements.State_Machines.StateMachine |
Behavioral_Elements.Activity_Graphs.ActivityGraph |
Behavioral_Elements.State_Machines.Event |
Behavioral_Elements.State_Machines.TimeEvent |
Behavioral_Elements.State_Machines.CallEvent |
Behavioral_Elements.State_Machines.SignalEvent |
Behavioral_Elements.State_Machines.ChangeEvent |
Behavioral_Elements.State_Machines.Transition |
Behavioral_Elements.State_Machines.StateVertex |
Behavioral_Elements.State_Machines.Pseudostate |
Behavioral_Elements.State_Machines.SynchState |
Behavioral_Elements.State_Machines.StubState |
Behavioral_Elements.State_Machines.State |
Behavioral_Elements.State_Machines.CompositeState |
Behavioral_Elements.State_Machines.SubmachineState |
Behavioral_Elements.Activity_Graphs.SubactivityState |
Behavioral_Elements.State_Machines.SimpleState |
Behavioral_Elements.Activity_Graphs.ObjectFlowState |
Behavioral_Elements.Activity_Graphs.ActionState |
Behavioral_Elements.Activity_Graphs.CallState |
Behavioral_Elements.State_Machines.FinalState |
Behavioral_Elements.State_Machines.Guard |
Behavioral_Elements.Collaborations.Message |
Behavioral_Elements.Collaborations.Interaction |
Behavioral_Elements.Activity_Graphs.Partition |
Foundation.Core.Feature |
Foundation.Core.BehavioralFeature |
Behavioral_Elements.Common_Behavior.Reception |
Foundation.Core.Operation |
Foundation.Core.Method |
Foundation.Core.StructuralFeature |
Foundation.Core.Attribute |
Foundation.Core.GeneralizableElement |
Foundation.Extension_Mechanisms.Stereotype |
Behavioral_Elements.Collaborations.Collaboration |
Model_Management.Package |
Model_Management.Subsystem |
Model_Management.Model |
Foundation.Core.Classifier |
Foundation.Core.Class |
Foundation.Core.DataType |
Foundation.Core.Interface |
Foundation.Core.Component |
Foundation.Core.Node |
Behavioral_Elements.Common_Behavior.Signal |
Behavioral_Elements.Common_Behavior.Exception |
Behavioral_Elements.Use_Cases.UseCase |
Behavioral_Elements.Use_Cases.Actor |
Behavioral_Elements.Collaborations.ClassifierRole |
Behavioral_Elements.Activity_Graphs.ClassifierInState |
Foundation.Core.AssociationEnd |
Behavioral_Elements.Collaborations.AssociationEndRole |
Foundation.Core.Namespace |
Foundation.Core.Parameter |
```

6 UML XMI DTD Specification

```
Foundation.Core.Constraint)*
>

<!ELEMENT Behavioral_Elements.Collaborations.ClassifierRole (Foundation.Core.ModelElement.name?,
Foundation.Core.ModelElement.visibility?,
Foundation.Core.ModelElement.isSpecification?,
Foundation.Core.GeneralizableElement.isRoot?,
Foundation.Core.GeneralizableElement.isLeaf?,
Foundation.Core.GeneralizableElement.isAbstract?,
Behavioral_Elements.Collaborations.ClassifierRole.multiplicity?,
XMI.extension*,
Foundation.Core.ModelElement.namespace?,
Foundation.Core.ModelElement.clientDependency*,
Foundation.Core.ModelElement.constraint*,
Foundation.Core.ModelElement.supplierDependency*,
Foundation.Core.ModelElement.presentation*,
Foundation.Core.ModelElement.targetFlow*,
Foundation.Core.ModelElement.sourceFlow*,
Foundation.Core.ModelElement.templateParameter3*,
Foundation.Core.ModelElement.binding?,
Foundation.Core.ModelElement.comment*,
Foundation.Core.ModelElement.elementResidence*,
Foundation.Core.ModelElement.templateParameter2*,
Foundation.Core.ModelElement.stereotype?,
Foundation.Core.ModelElement.behavior*,
Foundation.Core.ModelElement.classifierRole*,
Foundation.Core.ModelElement.collaboration*,
Foundation.Core.ModelElement.partition*,
Foundation.Core.ModelElement.elementImport*,
Foundation.Core.GeneralizableElement.generalization*,
Foundation.Core.GeneralizableElement.specialization*,
Foundation.Core.Classifier.participant*,
Foundation.Core.Classifier.powertypeRange*,
Foundation.Core.Classifier.instance*,
Foundation.Core.Classifier.createAction*,
Foundation.Core.Classifier.classifierRole*,
Foundation.Core.Classifier.collaboration*,
Foundation.Core.Classifier.classifierInState*,
Foundation.Core.Classifier.objectFlowState*,
Behavioral_Elements.Collaborations.ClassifierRole.base*,
Behavioral_Elements.Collaborations.ClassifierRole.associationEndRole*,
Behavioral_Elements.Collaborations.ClassifierRole.collaboration?,
Behavioral_Elements.Collaborations.ClassifierRole.availableFeature*,
Behavioral_Elements.Collaborations.ClassifierRole.message2*,
Behavioral_Elements.Collaborations.ClassifierRole.message1*,
Behavioral_Elements.Collaborations.ClassifierRole.availableContents*,
Foundation.Core.ModelElement.templateParameter*,
Foundation.Core.ModelElement.taggedValue*,
Foundation.Core.Namespace.ownedElement*,
Foundation.Core.Classifier.feature*)?
>

<!ATTLIST Behavioral_Elements.Collaborations.ClassifierRole
    %XMI.element.att;
    %XMI.link.att;
>

<!-- _____ -->
<!-- _____ -->
<!-- METAMODEL CLASS: AssociationRole -->
<!-- _____ -->

<!ELEMENT Behavioral_Elements.Collaborations.AssociationRole.multiplicity
(Foundation.Data_Types.Multiplicity) >

<!ELEMENT Behavioral_Elements.Collaborations.AssociationRole.base (Foundation.Core.Association |
Foundation.Core.AssociationClass |
Behavioral_Elements.Collaborations.AssociationRole)?
```

```

>
<!ELEMENT Behavioral_Elements.Collaborations.AssociationRole.collaboration
    (Behavioral_Elements.Collaborations.Collaboration)? >
<!ELEMENT Behavioral_Elements.Collaborations.AssociationRole.message
    (Behavioral_Elements.Collaborations.Message)* >
<!ELEMENT Behavioral_Elements.Collaborations.AssociationRole (Foundation.Core.ModelElement.name?,
    Foundation.Core.ModelElement.visibility?,
    Foundation.Core.ModelElement.isSpecification?,
    Foundation.Core.GeneralizableElement.isRoot?,
    Foundation.Core.GeneralizableElement.isLeaf?,
    Foundation.Core.GeneralizableElement.isAbstract?,
    Behavioral_Elements.Collaborations.AssociationRole.multiplicity?,
    XMI.extension*,
    Foundation.Core.ModelElement.namespace?,
    Foundation.Core.ModelElement.clientDependency*,
    Foundation.Core.ModelElement.constraint*,
    Foundation.Core.ModelElement.supplierDependency*,
    Foundation.Core.ModelElement.presentation*,
    Foundation.Core.ModelElement.targetFlow*,
    Foundation.Core.ModelElement.sourceFlow*,
    Foundation.Core.ModelElement.templateParameter3*,
    Foundation.Core.ModelElement.binding?,
    Foundation.Core.ModelElement.comment*,
    Foundation.Core.ModelElement.elementResidence*,
    Foundation.Core.ModelElement.templateParameter2*,
    Foundation.Core.ModelElement.stereotype?,
    Foundation.Core.ModelElement.behavior*,
    Foundation.Core.ModelElement.classifierRole*,
    Foundation.Core.ModelElement.collaboration*,
    Foundation.Core.ModelElement.partition*,
    Foundation.Core.ModelElement.elementImport*,
    Foundation.Core.GeneralizableElement.generalization*,
    Foundation.Core.GeneralizableElement.specialization*,
    Foundation.Core.Association.link*,
    Foundation.Core.Association.associationRole*,
    Behavioral_Elements.Collaborations.AssociationRole.base?,
    Behavioral_Elements.Collaborations.AssociationRole.collaboration?,
    Behavioral_Elements.Collaborations.AssociationRole.message*,
    Foundation.Core.ModelElement.templateParameter*,
    Foundation.Core.ModelElement.taggedValue*,
    Foundation.Core.Association.connection*)?
>
<!ATTLIST Behavioral_Elements.Collaborations.AssociationRole
    %XMI.element.att;
    %XMI.link.att;
>
<!-- _____ -->
<!-- _____ -->
<!-- METAMODEL CLASS: AssociationEndRole -->
<!-- _____ -->

<!ELEMENT Behavioral_Elements.Collaborations.AssociationEndRole.collaborationMultiplicity
    (Foundation.Data_Types.Multiplicity) >
<!ELEMENT Behavioral_Elements.Collaborations.AssociationEndRole.associationRole
    (Behavioral_Elements.Collaborations.AssociationRole)? >
<!ELEMENT Behavioral_Elements.Collaborations.AssociationEndRole.base (Foundation.Core.AssociationEnd |
    Behavioral_Elements.Collaborations.AssociationEndRole)?
>
<!ELEMENT Behavioral_Elements.Collaborations.AssociationEndRole.availableQualifier
    (Foundation.Core.Attribute)* >

```

6 UML XMI DTD Specification

```
<!ELEMENT Behavioral_Elements.Collaborations.AssociationEndRole (Foundation.Core.ModelElement.name?,
                                                                    Foundation.Core.ModelElement.visibility?,
                                                                    Foundation.Core.ModelElement.isSpecification?,
                                                                    Foundation.Core.AssociationEnd.isNavigable?,
                                                                    Foundation.Core.AssociationEnd.ordering?,
                                                                    Foundation.Core.AssociationEnd.aggregation?,
                                                                    Foundation.Core.AssociationEnd.targetScope?,
                                                                    Foundation.Core.AssociationEnd.multiplicity?,
                                                                    Foundation.Core.AssociationEnd.changeability?,

Behavioral_Elements.Collaborations.AssociationEndRole.collaborationMultiplicity?,
                                                                    XMI.extension*,
                                                                    Foundation.Core.ModelElement.namespace?,
                                                                    Foundation.Core.ModelElement.clientDependency*,
                                                                    Foundation.Core.ModelElement.constraint*,
                                                                    Foundation.Core.ModelElement.supplierDependency*,
                                                                    Foundation.Core.ModelElement.presentation*,
                                                                    Foundation.Core.ModelElement.targetFlow*,
                                                                    Foundation.Core.ModelElement.sourceFlow*,
                                                                    Foundation.Core.ModelElement.templateParameter3*,
                                                                    Foundation.Core.ModelElement.binding?,
                                                                    Foundation.Core.ModelElement.comment*,
                                                                    Foundation.Core.ModelElement.elementResidence*,
                                                                    Foundation.Core.ModelElement.templateParameter2*,
                                                                    Foundation.Core.ModelElement.stereotype?,
                                                                    Foundation.Core.ModelElement.behavior*,
                                                                    Foundation.Core.ModelElement.classifierRole*,
                                                                    Foundation.Core.ModelElement.collaboration*,
                                                                    Foundation.Core.ModelElement.partition*,
                                                                    Foundation.Core.ModelElement.elementImport*,
                                                                    Foundation.Core.AssociationEnd.association?,
                                                                    Foundation.Core.AssociationEnd.type?,
                                                                    Foundation.Core.AssociationEnd.specification*,
                                                                    Foundation.Core.AssociationEnd.linkEnd*,
                                                                    Foundation.Core.AssociationEnd.associationEndRole*,
                                                                    Behavioral_Elements.Collaborations.AssociationEndRole.associationRole?,
                                                                    Behavioral_Elements.Collaborations.AssociationEndRole.base?,

Behavioral_Elements.Collaborations.AssociationEndRole.availableQualifier*,
                                                                    Foundation.Core.ModelElement.templateParameter*,
                                                                    Foundation.Core.ModelElement.taggedValue*,
                                                                    Foundation.Core.AssociationEnd.qualified*)?
>

<!ATTLIST Behavioral_Elements.Collaborations.AssociationEndRole
    %XMI.element.att;
    %XMI.link.att;
>

<!-- _____ -->
<!-- _____ -->
<!-- METAMODEL CLASS: Message -->
<!-- _____ -->

<!ELEMENT Behavioral_Elements.Collaborations.Message.interaction
                                                                    (Behavioral_Elements.Collaborations.Interaction)? >

<!ELEMENT Behavioral_Elements.Collaborations.Message.activator
                                                                    (Behavioral_Elements.Collaborations.Message)? >

<!ELEMENT Behavioral_Elements.Collaborations.Message.message4
                                                                    (Behavioral_Elements.Collaborations.Message)* >

<!ELEMENT Behavioral_Elements.Collaborations.Message.sender
                                                                    (Behavioral_Elements.Collaborations.ClassifierRole)? >

<!ELEMENT Behavioral_Elements.Collaborations.Message.receiver
```

6.3 UML XMI DTD

```
(Behavioral_Elements.Collaborations.ClassifierRole)? >

<!ELEMENT Behavioral_Elements.Collaborations.Message.message3
(Behavioral_Elements.Collaborations.Message)* >

<!ELEMENT Behavioral_Elements.Collaborations.Message.predecessor
(Behavioral_Elements.Collaborations.Message)* >

<!ELEMENT Behavioral_Elements.Collaborations.Message.communicationConnection
(Behavioral_Elements.Collaborations.AssociationRole)? >

<!ELEMENT Behavioral_Elements.Collaborations.Message.action (Behavioral_Elements.Common_Behavior.Action |
Behavioral_Elements.Common_Behavior.CallAction |
Behavioral_Elements.Common_Behavior.SendAction |
Behavioral_Elements.Common_Behavior.ActionSequence |
Behavioral_Elements.Common_Behavior.ReturnAction |
Behavioral_Elements.Common_Behavior.TerminateAction |
Behavioral_Elements.Common_Behavior.DestroyAction |
Behavioral_Elements.Common_Behavior.CreateAction |
Behavioral_Elements.Common_Behavior.UninterpretedAction)?
>

<!ELEMENT Behavioral_Elements.Collaborations.Message (Foundation.Core.ModelElement.name?,
Foundation.Core.ModelElement.visibility?,
Foundation.Core.ModelElement.isSpecification?,
XMI.extension*,
Foundation.Core.ModelElement.namespace?,
Foundation.Core.ModelElement.clientDependency*,
Foundation.Core.ModelElement.constraint*,
Foundation.Core.ModelElement.supplierDependency*,
Foundation.Core.ModelElement.presentation*,
Foundation.Core.ModelElement.targetFlow*,
Foundation.Core.ModelElement.sourceFlow*,
Foundation.Core.ModelElement.templateParameter3*,
Foundation.Core.ModelElement.binding?,
Foundation.Core.ModelElement.comment*,
Foundation.Core.ModelElement.elementResidence*,
Foundation.Core.ModelElement.templateParameter2*,
Foundation.Core.ModelElement.stereotype?,
Foundation.Core.ModelElement.behavior*,
Foundation.Core.ModelElement.classifierRole*,
Foundation.Core.ModelElement.collaboration*,
Foundation.Core.ModelElement.partition*,
Foundation.Core.ModelElement.elementImport*,
Behavioral_Elements.Collaborations.Message.interaction?,
Behavioral_Elements.Collaborations.Message.activator?,
Behavioral_Elements.Collaborations.Message.message4*,
Behavioral_Elements.Collaborations.Message.sender?,
Behavioral_Elements.Collaborations.Message.receiver?,
Behavioral_Elements.Collaborations.Message.message3*,
Behavioral_Elements.Collaborations.Message.predecessor*,
Behavioral_Elements.Collaborations.Message.communicationConnection?,
Behavioral_Elements.Collaborations.Message.action?,
Foundation.Core.ModelElement.templateParameter*,
Foundation.Core.ModelElement.taggedValue*)?
>

<!ATTLIST Behavioral_Elements.Collaborations.Message
%XMI.element.att;
%XMI.link.att;
>

<!-- _____ -->
<!-- _____ -->
<!-- METAMODEL CLASS: Interaction -->
<!-- _____ -->

<!ELEMENT Behavioral_Elements.Collaborations.Interaction.context
```

6 UML XMI DTD Specification

```
(Behavioral_Elements.Collaborations.Collaboration)? >

<!ELEMENT Behavioral_Elements.Collaborations.Interaction (Foundation.Core.ModelElement.name?,
Foundation.Core.ModelElement.visibility?,
Foundation.Core.ModelElement.isSpecification?,
XMI.extension*,
Foundation.Core.ModelElement.namespace?,
Foundation.Core.ModelElement.clientDependency*,
Foundation.Core.ModelElement.constraint*,
Foundation.Core.ModelElement.supplierDependency*,
Foundation.Core.ModelElement.presentation*,
Foundation.Core.ModelElement.targetFlow*,
Foundation.Core.ModelElement.sourceFlow*,
Foundation.Core.ModelElement.templateParameter3*,
Foundation.Core.ModelElement.binding?,
Foundation.Core.ModelElement.comment*,
Foundation.Core.ModelElement.elementResidence*,
Foundation.Core.ModelElement.templateParameter2*,
Foundation.Core.ModelElement.stereotype?,
Foundation.Core.ModelElement.behavior*,
Foundation.Core.ModelElement.classifierRole*,
Foundation.Core.ModelElement.collaboration*,
Foundation.Core.ModelElement.partition*,
Foundation.Core.ModelElement.elementImport*,
Behavioral_Elements.Collaborations.Interaction.context?,
Foundation.Core.ModelElement.templateParameter*,
Foundation.Core.ModelElement.taggedValue*,
Behavioral_Elements.Collaborations.Interaction.message*)?
>

<!ATTLIST Behavioral_Elements.Collaborations.Interaction
    %XMI.element.att;
    %XMI.link.att;
>

<!ELEMENT Behavioral_Elements.Collaborations ((Behavioral_Elements.Collaborations.Collaboration |
Behavioral_Elements.Collaborations.ClassifierRole |
Behavioral_Elements.Collaborations.AssociationRole |
Behavioral_Elements.Collaborations.AssociationEndRole |
Behavioral_Elements.Collaborations.Message |
Behavioral_Elements.Collaborations.Interaction)*)
>

<!ATTLIST Behavioral_Elements.Collaborations
    %XMI.element.att;
    %XMI.link.att;
>

<!-- _____ -->
<!-- _____ -->
<!-- METAMODEL PACKAGE: Activity_Graphs _____ -->
<!-- _____ -->

<!ELEMENT Behavioral_Elements.Activity_Graphs.ActivityGraph.partition
(Behavioral_Elements.Activity_Graphs.Partition)* >

<!-- _____ -->
<!-- _____ -->
<!-- METAMODEL CLASS: ActivityGraph _____ -->
<!-- _____ -->

<!ELEMENT Behavioral_Elements.Activity_Graphs.ActivityGraph (Foundation.Core.ModelElement.name?,
Foundation.Core.ModelElement.visibility?,
Foundation.Core.ModelElement.isSpecification?,
XMI.extension*,
Foundation.Core.ModelElement.namespace?,
Foundation.Core.ModelElement.clientDependency*,
Foundation.Core.ModelElement.constraint*,
```

```

Foundation.Core.ModelElement.supplierDependency*,
Foundation.Core.ModelElement.presentation*,
Foundation.Core.ModelElement.targetFlow*,
Foundation.Core.ModelElement.sourceFlow*,
Foundation.Core.ModelElement.templateParameter3*,
Foundation.Core.ModelElement.binding?,
Foundation.Core.ModelElement.comment*,
Foundation.Core.ModelElement.elementResidence*,
Foundation.Core.ModelElement.templateParameter2*,
Foundation.Core.ModelElement.stereotype?,
Foundation.Core.ModelElement.behavior*,
Foundation.Core.ModelElement.classifierRole*,
Foundation.Core.ModelElement.collaboration*,
Foundation.Core.ModelElement.partition*,
Foundation.Core.ModelElement.elementImport*,
Behavioral_Elements.State_Machines.StateMachine.context?,
Behavioral_Elements.State_Machines.StateMachine.subMachineState*,
Foundation.Core.ModelElement.templateParameter*,
Foundation.Core.ModelElement.taggedValue*,
Behavioral_Elements.State_Machines.StateMachine.top?,
Behavioral_Elements.State_Machines.StateMachine.transitions*,
Behavioral_Elements.Activity_Graphs.ActivityGraph.partition*)?
>
<!ATTLIST Behavioral_Elements.Activity_Graphs.ActivityGraph
    %XMI.element.att;
    %XMI.link.att;
>
<!-- _____ -->
<!-- _____ -->
<!-- METAMODEL CLASS: Partition _____ -->
<!-- _____ -->

<!ELEMENT Behavioral_Elements.Activity_Graphs.Partition.contents (Foundation.Core.ModelElement |
    Foundation.Core.Comment |
    Foundation.Core.Relationship |
    Behavioral_Elements.Use_Cases.Extend |
    Behavioral_Elements.Use_Cases.Include |
    Foundation.Core.Generalization |
    Foundation.Core.Flow |
    Foundation.Core.Association |
    Foundation.Core.AssociationClass |
    Behavioral_Elements.Collaborations.AssociationRole |
    Foundation.Core.Dependency |
    Foundation.Core.Abstraction |
    Foundation.Core.Usage |
    Foundation.Core.Binding |
    Foundation.Core.Permission |
    Foundation.Extension_Mechanisms.TaggedValue |
    Behavioral_Elements.Common_Behavior.Instance |
    Behavioral_Elements.Common_Behavior.Object |
    Behavioral_Elements.Common_Behavior.LinkObject |
    Behavioral_Elements.Common_Behavior.DataValue |
    Behavioral_Elements.Common_Behavior.ComponentInstance |
    Behavioral_Elements.Common_Behavior.NodeInstance |
    Behavioral_Elements.Use_Cases.UseCaseInstance |
    Behavioral_Elements.Common_Behavior.Action |
    Behavioral_Elements.Common_Behavior.CallAction |
    Behavioral_Elements.Common_Behavior.SendAction |
    Behavioral_Elements.Common_Behavior.ActionSequence |
    Behavioral_Elements.Common_Behavior.ReturnAction |
    Behavioral_Elements.Common_Behavior.TerminateAction |
    Behavioral_Elements.Common_Behavior.DestroyAction |
    Behavioral_Elements.Common_Behavior.CreateAction |
    Behavioral_Elements.Common_Behavior.UninterpretedAction |
    Behavioral_Elements.Common_Behavior.AttributeLink |
    Behavioral_Elements.Common_Behavior.Argument |

```

6 UML XMI DTD Specification

```
Behavioral_Elements.Common_Behavior.Link |
Behavioral_Elements.Common_Behavior.LinkEnd |
Behavioral_Elements.Common_Behavior.Stimulus |
Behavioral_Elements.Use_Cases.ExtensionPoint |
Behavioral_Elements.State_Machines.StateMachine |
Behavioral_Elements.Activity_Graphs.ActivityGraph |
Behavioral_Elements.State_Machines.Event |
Behavioral_Elements.State_Machines.TimeEvent |
Behavioral_Elements.State_Machines.CallEvent |
Behavioral_Elements.State_Machines.SignalEvent |
Behavioral_Elements.State_Machines.ChangeEvent |
Behavioral_Elements.State_Machines.Transition |
Behavioral_Elements.State_Machines.StateVertex |
Behavioral_Elements.State_Machines.Pseudostate |
Behavioral_Elements.State_Machines.SynchState |
Behavioral_Elements.State_Machines.StubState |
Behavioral_Elements.State_Machines.State |
Behavioral_Elements.State_Machines.CompositeState |
Behavioral_Elements.State_Machines.SubmachineState |
Behavioral_Elements.Activity_Graphs.SubactivityState |
Behavioral_Elements.State_Machines.SimpleState |
Behavioral_Elements.Activity_Graphs.ObjectFlowState |
Behavioral_Elements.Activity_Graphs.ActionState |
Behavioral_Elements.Activity_Graphs.CallState |
Behavioral_Elements.State_Machines.FinalState |
Behavioral_Elements.State_Machines.Guard |
Behavioral_Elements.Collaborations.Message |
Behavioral_Elements.Collaborations.Interaction |
Behavioral_Elements.Activity_Graphs.Partition |
Foundation.Core.Feature |
Foundation.Core.BehavioralFeature |
Behavioral_Elements.Common_Behavior.Reception |
Foundation.Core.Operation |
Foundation.Core.Method |
Foundation.Core.StructuralFeature |
Foundation.Core.Attribute |
Foundation.Core.GeneralizableElement |
Foundation.Extension_Mechanisms.Stereotype |
Behavioral_Elements.Collaborations.Collaboration |
Model_Management.Package |
Model_Management.Subsystem |
Model_Management.Model |
Foundation.Core.Classifier |
Foundation.Core.Class |
Foundation.Core.DataType |
Foundation.Core.Interface |
Foundation.Core.Component |
Foundation.Core.Node |
Behavioral_Elements.Common_Behavior.Signal |
Behavioral_Elements.Common_Behavior.Exception |
Behavioral_Elements.Use_Cases.UseCase |
Behavioral_Elements.Use_Cases.Actor |
Behavioral_Elements.Collaborations.ClassifierRole |
Behavioral_Elements.Activity_Graphs.ClassifierInState |
Foundation.Core.AssociationEnd |
Behavioral_Elements.Collaborations.AssociationEndRole |
Foundation.Core.Namespace |
Foundation.Core.Parameter |
Foundation.Core.Constraint)*
>
```

```
<!ELEMENT Behavioral_Elements.Activity_Graphs.Partition.activityGraph
    (Behavioral_Elements.Activity_Graphs.ActivityGraph)? >
```

```
<!ELEMENT Behavioral_Elements.Activity_Graphs.Partition (Foundation.Core.ModelElement.name?,
    Foundation.Core.ModelElement.visibility?,
    Foundation.Core.ModelElement.isSpecification?,
    XMI.extension*,
```

```

Foundation.Core.ModelElement.namespace?,
Foundation.Core.ModelElement.clientDependency*,
Foundation.Core.ModelElement.constraint*,
Foundation.Core.ModelElement.supplierDependency*,
Foundation.Core.ModelElement.presentation*,
Foundation.Core.ModelElement.targetFlow*,
Foundation.Core.ModelElement.sourceFlow*,
Foundation.Core.ModelElement.templateParameter3*,
Foundation.Core.ModelElement.binding?,
Foundation.Core.ModelElement.comment*,
Foundation.Core.ModelElement.elementResidence*,
Foundation.Core.ModelElement.templateParameter2*,
Foundation.Core.ModelElement.stereotype?,
Foundation.Core.ModelElement.behavior*,
Foundation.Core.ModelElement.classifierRole*,
Foundation.Core.ModelElement.collaboration*,
Foundation.Core.ModelElement.partition*,
Foundation.Core.ModelElement.elementImport*,
Behavioral_Elements.Activity_Graphs.Partition.contents*,
Behavioral_Elements.Activity_Graphs.Partition.activityGraph?,
Foundation.Core.ModelElement.templateParameter*,
Foundation.Core.ModelElement.taggedValue*)?
>

<!ATTLIST Behavioral_Elements.Activity_Graphs.Partition
    %XMI.element.att;
    %XMI.link.att;
>

<!-- _____ -->
<!-- _____ -->
<!-- METAMODEL CLASS: SubactivityState -->
<!-- _____ -->

<!ELEMENT Behavioral_Elements.Activity_Graphs.SubactivityState.isDynamic
    EMPTY >

<!ATTLIST Behavioral_Elements.Activity_Graphs.SubactivityState.isDynamic
    xmi.value ( true | false ) #REQUIRED
>

<!ELEMENT Behavioral_Elements.Activity_Graphs.SubactivityState.dynamicArguments
    (Foundation.Data_Types.ArgListsExpression) >

<!ELEMENT Behavioral_Elements.Activity_Graphs.SubactivityState.dynamicMultiplicity
    (Foundation.Data_Types.Multiplicity) >

<!ELEMENT Behavioral_Elements.Activity_Graphs.SubactivityState (Foundation.Core.ModelElement.name?,
    Foundation.Core.ModelElement.visibility?,
    Foundation.Core.ModelElement.isSpecification?,
    Behavioral_Elements.State_Machines.CompositeState.isConcurrent?,
    Behavioral_Elements.Activity_Graphs.SubactivityState.isDynamic?,
    Behavioral_Elements.Activity_Graphs.SubactivityState.dynamicArguments?,
    Behavioral_Elements.Activity_Graphs.SubactivityState.dynamicMultiplicity?,
    XMI.extension*,
    Foundation.Core.ModelElement.namespace?,
    Foundation.Core.ModelElement.clientDependency*,
    Foundation.Core.ModelElement.constraint*,
    Foundation.Core.ModelElement.supplierDependency*,
    Foundation.Core.ModelElement.presentation*,
    Foundation.Core.ModelElement.targetFlow*,
    Foundation.Core.ModelElement.sourceFlow*,
    Foundation.Core.ModelElement.templateParameter3*,
    Foundation.Core.ModelElement.binding?,
    Foundation.Core.ModelElement.comment*,
    Foundation.Core.ModelElement.elementResidence*,
    Foundation.Core.ModelElement.templateParameter2*,
    Foundation.Core.ModelElement.stereotype?,

```

6 UML XMI DTD Specification

```
Foundation.Core.ModelElement.behavior*,
Foundation.Core.ModelElement.classifierRole*,
Foundation.Core.ModelElement.collaboration*,
Foundation.Core.ModelElement.partition*,
Foundation.Core.ModelElement.elementImport*,
Behavioral_Elements.State_Machines.StateVertex.container?,
Behavioral_Elements.State_Machines.StateVertex.outgoing*,
Behavioral_Elements.State_Machines.StateVertex.incoming*,
Behavioral_Elements.State_Machines.State.stateMachine?,
Behavioral_Elements.State_Machines.State.deferrableEvent*,
Behavioral_Elements.State_Machines.State.classifierInState*,
Behavioral_Elements.State_Machines.SubmachineState.submachine?,
Foundation.Core.ModelElement.templateParameter*,
Foundation.Core.ModelElement.taggedValue*,
Behavioral_Elements.State_Machines.State.entry?,
Behavioral_Elements.State_Machines.State.exit?,
Behavioral_Elements.State_Machines.State.internalTransition*,
Behavioral_Elements.State_Machines.State.doActivity?,
Behavioral_Elements.State_Machines.CompositeState.subvertex* )?
>
<!-- Behavioral_Elements.Activity_Graphs.SubactivityState
      %XMI.element.att;
      %XMI.link.att;
-->
<!-- _____ -->
<!-- _____ -->
<!-- METAMODEL CLASS: CallState -->
<!-- _____ -->

<!-- ELEMENT Behavioral_Elements.Activity_Graphs.CallState ( Foundation.Core.ModelElement.name?,
Foundation.Core.ModelElement.visibility?,
Foundation.Core.ModelElement.isSpecification?,
Behavioral_Elements.Activity_Graphs.ActionState.isDynamic?,
Behavioral_Elements.Activity_Graphs.ActionState.dynamicArguments?,
Behavioral_Elements.Activity_Graphs.ActionState.dynamicMultiplicity?,
XMI.extension*,
Foundation.Core.ModelElement.namespace?,
Foundation.Core.ModelElement.clientDependency*,
Foundation.Core.ModelElement.constraint*,
Foundation.Core.ModelElement.supplierDependency*,
Foundation.Core.ModelElement.presentation*,
Foundation.Core.ModelElement.targetFlow*,
Foundation.Core.ModelElement.sourceFlow*,
Foundation.Core.ModelElement.templateParameter3*,
Foundation.Core.ModelElement.binding?,
Foundation.Core.ModelElement.comment*,
Foundation.Core.ModelElement.elementResidence*,
Foundation.Core.ModelElement.templateParameter2*,
Foundation.Core.ModelElement.stereotype?,
Foundation.Core.ModelElement.behavior*,
Foundation.Core.ModelElement.classifierRole*,
Foundation.Core.ModelElement.collaboration*,
Foundation.Core.ModelElement.partition*,
Foundation.Core.ModelElement.elementImport*,
Behavioral_Elements.State_Machines.StateVertex.container?,
Behavioral_Elements.State_Machines.StateVertex.outgoing*,
Behavioral_Elements.State_Machines.StateVertex.incoming*,
Behavioral_Elements.State_Machines.State.stateMachine?,
Behavioral_Elements.State_Machines.State.deferrableEvent*,
Behavioral_Elements.State_Machines.State.classifierInState*,
Foundation.Core.ModelElement.templateParameter*,
Foundation.Core.ModelElement.taggedValue*,
Behavioral_Elements.State_Machines.State.entry?,
Behavioral_Elements.State_Machines.State.exit?,
Behavioral_Elements.State_Machines.State.internalTransition*,
Behavioral_Elements.State_Machines.State.doActivity?)?
-->
```

```

>
<!ATTLIST Behavioral_Elements.Activity_Graphs.CallState
    %XMI.element.att;
    %XMI.link.att;
>

<!-- _____ -->
<!-- _____ -->
<!-- METAMODEL CLASS: ObjectFlowState -->
<!-- _____ -->

<!ELEMENT Behavioral_Elements.Activity_Graphs.ObjectFlowState.isSynch
    EMPTY >
<!ATTLIST Behavioral_Elements.Activity_Graphs.ObjectFlowState.isSynch
    xmi.value ( true | false ) #REQUIRED
>

<!ELEMENT Behavioral_Elements.Activity_Graphs.ObjectFlowState.parameter
    (Foundation.Core.Parameter)* >

<!ELEMENT Behavioral_Elements.Activity_Graphs.ObjectFlowState.type (Foundation.Core.Classifier |
    Foundation.Core.Class |
    Foundation.Core.AssociationClass |
    Foundation.Core.DataType |
    Foundation.Core.Interface |
    Foundation.Core.Component |
    Foundation.Core.Node |
    Behavioral_Elements.Common_Behavior.Signal |
    Behavioral_Elements.Common_Behavior.Exception |
    Behavioral_Elements.Use_Cases.UseCase |
    Behavioral_Elements.Use_Cases.Actor |
    Behavioral_Elements.Collaborations.ClassifierRole |
    Behavioral_Elements.Activity_Graphs.ClassifierInState |
    Model_Management.Subsystem)?
>

<!ELEMENT Behavioral_Elements.Activity_Graphs.ObjectFlowState (Foundation.Core.ModelElement.name?,
    Foundation.Core.ModelElement.visibility?,
    Foundation.Core.ModelElement.isSpecification?,
    Behavioral_Elements.Activity_Graphs.ObjectFlowState.isSynch?,
    XMI.extension*,
    Foundation.Core.ModelElement.namespace?,
    Foundation.Core.ModelElement.clientDependency*,
    Foundation.Core.ModelElement.constraint*,
    Foundation.Core.ModelElement.supplierDependency*,
    Foundation.Core.ModelElement.presentation*,
    Foundation.Core.ModelElement.targetFlow*,
    Foundation.Core.ModelElement.sourceFlow*,
    Foundation.Core.ModelElement.templateParameter3*,
    Foundation.Core.ModelElement.binding?,
    Foundation.Core.ModelElement.comment*,
    Foundation.Core.ModelElement.elementResidence*,
    Foundation.Core.ModelElement.templateParameter2*,
    Foundation.Core.ModelElement.stereotype?,
    Foundation.Core.ModelElement.behavior*,
    Foundation.Core.ModelElement.classifierRole*,
    Foundation.Core.ModelElement.collaboration*,
    Foundation.Core.ModelElement.partition*,
    Foundation.Core.ModelElement.elementImport*,
    Behavioral_Elements.State_Machines.StateVertex.container?,
    Behavioral_Elements.State_Machines.StateVertex.outgoing*,
    Behavioral_Elements.State_Machines.StateVertex.incoming*,
    Behavioral_Elements.State_Machines.State.stateMachine?,
    Behavioral_Elements.State_Machines.State.deferrableEvent*,
    Behavioral_Elements.State_Machines.State.classifierInState*,
    Behavioral_Elements.Activity_Graphs.ObjectFlowState.parameter*,
    Behavioral_Elements.Activity_Graphs.ObjectFlowState.type?,

```

6 UML XMI DTD Specification

```
Foundation.Core.ModelElement.templateParameter*,
Foundation.Core.ModelElement.taggedValue*,
Behavioral_Elements.State_Machines.State.entry?,
Behavioral_Elements.State_Machines.State.exit?,
Behavioral_Elements.State_Machines.State.internalTransition*,
Behavioral_Elements.State_Machines.State.doActivity)?
>
<!ATTLIST Behavioral_Elements.Activity_Graphs.ObjectFlowState
    %XMI.element.att;
    %XMI.link.att;
>
<!-- _____ -->
<!-- _____ -->
<!-- METAMODEL CLASS: ClassifierInState -->
<!-- _____ -->
<!ELEMENT Behavioral_Elements.Activity_Graphs.ClassifierInState.type (Foundation.Core.Classifier |
    Foundation.Core.Class |
    Foundation.Core.AssociationClass |
    Foundation.Core.DataType |
    Foundation.Core.Interface |
    Foundation.Core.Component |
    Foundation.Core.Node |
    Behavioral_Elements.Common_Behavior.Signal |
    Behavioral_Elements.Common_Behavior.Exception |
    Behavioral_Elements.Use_Cases.UseCase |
    Behavioral_Elements.Use_Cases.Actor |
    Behavioral_Elements.Collaborations.ClassifierRole |
    Behavioral_Elements.Activity_Graphs.ClassifierInState |
    Model_Management.Subsystem)?
>
<!ELEMENT Behavioral_Elements.Activity_Graphs.ClassifierInState.inState (Behavioral_Elements.State_Machines.State |
    Behavioral_Elements.State_Machines.CompositeState |
    Behavioral_Elements.State_Machines.SubmachineState |
    Behavioral_Elements.Activity_Graphs.SubactivityState |
    Behavioral_Elements.State_Machines.SimpleState |
    Behavioral_Elements.Activity_Graphs.ObjectFlowState |
    Behavioral_Elements.Activity_Graphs.ActionState |
    Behavioral_Elements.Activity_Graphs.CallState |
    Behavioral_Elements.State_Machines.FinalState)*
>
<!ELEMENT Behavioral_Elements.Activity_Graphs.ClassifierInState (Foundation.Core.ModelElement.name?,
    Foundation.Core.ModelElement.visibility?,
    Foundation.Core.ModelElement.isSpecification?,
    Foundation.Core.GeneralizableElement.isRoot?,
    Foundation.Core.GeneralizableElement.isLeaf?,
    Foundation.Core.GeneralizableElement.isAbstract?,
    XMI.extension*,
    Foundation.Core.ModelElement.namespace?,
    Foundation.Core.ModelElement.clientDependency*,
    Foundation.Core.ModelElement.constraint*,
    Foundation.Core.ModelElement.supplierDependency*,
    Foundation.Core.ModelElement.presentation*,
    Foundation.Core.ModelElement.targetFlow*,
    Foundation.Core.ModelElement.sourceFlow*,
    Foundation.Core.ModelElement.templateParameter3*,
    Foundation.Core.ModelElement.binding?,
    Foundation.Core.ModelElement.comment*,
    Foundation.Core.ModelElement.elementResidence*,
    Foundation.Core.ModelElement.templateParameter2*,
    Foundation.Core.ModelElement.stereotype?,
    Foundation.Core.ModelElement.behavior*,
    Foundation.Core.ModelElement.classifierRole*,
    Foundation.Core.ModelElement.collaboration*,
```



```

Foundation.Core.ModelElement.partition*,
Foundation.Core.ModelElement.elementImport*,
Foundation.Core.GeneralizableElement.generalization*,
Foundation.Core.GeneralizableElement.specialization*,
Foundation.Core.Classifier.participant*,
Foundation.Core.Classifier.powertypeRange*,
Foundation.Core.Classifier.instance*,
Foundation.Core.Classifier.createAction*,
Foundation.Core.Classifier.classifierRole*,
Foundation.Core.Classifier.collaboration*,
Foundation.Core.Classifier.classifierInState*,
Foundation.Core.Classifier.objectFlowState*,
Behavioral_Elements.Activity_Graphs.ClassifierInState.type?,
Behavioral_Elements.Activity_Graphs.ClassifierInState.inState*,
Foundation.Core.ModelElement.templateParameter*,
Foundation.Core.ModelElement.taggedValue*,
Foundation.Core.Namespace.ownedElement*,
Foundation.Core.Classifier.feature*)?
>
<!ATTLIST Behavioral_Elements.Activity_Graphs.ClassifierInState
    %XMI.element.att;
    %XMI.link.att;
>
<!-- _____ -->
<!-- _____ -->
<!-- METAMODEL CLASS:  ActionState _____ -->
<!-- _____ -->

<!ELEMENT Behavioral_Elements.Activity_Graphs.ActionState.isDynamic
    EMPTY >
<!ATTLIST Behavioral_Elements.Activity_Graphs.ActionState.isDynamic
    xmi.value ( true | false ) #REQUIRED
>
<!ELEMENT Behavioral_Elements.Activity_Graphs.ActionState.dynamicArguments
    (Foundation.Data_Types.ArgListsExpression) >
<!ELEMENT Behavioral_Elements.Activity_Graphs.ActionState.dynamicMultiplicity
    (Foundation.Data_Types.Multiplicity) >
<!ELEMENT Behavioral_Elements.Activity_Graphs.ActionState (Foundation.Core.ModelElement.name?,
    Foundation.Core.ModelElement.visibility?,
    Foundation.Core.ModelElement.isSpecification?,
    Behavioral_Elements.Activity_Graphs.ActionState.isDynamic?,
    Behavioral_Elements.Activity_Graphs.ActionState.dynamicArguments?,
    Behavioral_Elements.Activity_Graphs.ActionState.dynamicMultiplicity?,
    XMI.extension*,
    Foundation.Core.ModelElement.namespace?,
    Foundation.Core.ModelElement.clientDependency*,
    Foundation.Core.ModelElement.constraint*,
    Foundation.Core.ModelElement.supplierDependency*,
    Foundation.Core.ModelElement.presentation*,
    Foundation.Core.ModelElement.targetFlow*,
    Foundation.Core.ModelElement.sourceFlow*,
    Foundation.Core.ModelElement.templateParameter3*,
    Foundation.Core.ModelElement.binding?,
    Foundation.Core.ModelElement.comment*,
    Foundation.Core.ModelElement.elementResidence*,
    Foundation.Core.ModelElement.templateParameter2*,
    Foundation.Core.ModelElement.stereotype?,
    Foundation.Core.ModelElement.behavior*,
    Foundation.Core.ModelElement.classifierRole*,
    Foundation.Core.ModelElement.collaboration*,
    Foundation.Core.ModelElement.partition*,
    Foundation.Core.ModelElement.elementImport*,
    Behavioral_Elements.State_Machines.StateVertex.container?,

```

6 UML XMI DTD Specification

```
Behavioral_Elements.State_Machines.StateVertex.outgoing*,
Behavioral_Elements.State_Machines.StateVertex.incoming*,
Behavioral_Elements.State_Machines.State.stateMachine?,
Behavioral_Elements.State_Machines.State.deferrableEvent*,
Behavioral_Elements.State_Machines.State.classifierInState*,
Foundation.Core.ModelElement.templateParameter*,
Foundation.Core.ModelElement.taggedValue*,
Behavioral_Elements.State_Machines.State.entry?,
Behavioral_Elements.State_Machines.State.exit?,
Behavioral_Elements.State_Machines.State.internalTransition*,
Behavioral_Elements.State_Machines.State.doActivity?})?
>

<!ATTLIST Behavioral_Elements.Activity_Graphs.ActionState
    %XMI.element.att;
    %XMI.link.att;
>

<!ELEMENT Behavioral_Elements.Activity_Graphs ((Behavioral_Elements.Activity_Graphs.ActivityGraph |
Behavioral_Elements.Activity_Graphs.Partition |
Behavioral_Elements.Activity_Graphs.SubactivityState |
Behavioral_Elements.Activity_Graphs.CallState |
Behavioral_Elements.Activity_Graphs.ObjectFlowState |
Behavioral_Elements.Activity_Graphs.ClassifierInState |
Behavioral_Elements.Activity_Graphs.ActionState)*)
>

<!ATTLIST Behavioral_Elements.Activity_Graphs
    %XMI.element.att;
    %XMI.link.att;
>

<!ELEMENT Behavioral_Elements ((Behavioral_Elements.Common_Behavior |
Behavioral_Elements.Use_Cases |
Behavioral_Elements.State_Machines |
Behavioral_Elements.Collaborations |
Behavioral_Elements.Activity_Graphs)*) >

<!ATTLIST Behavioral_Elements
    %XMI.element.att;
    %XMI.link.att;
>

<!-- ----->
<!-- ----->
<!-- METAMODEL PACKAGE: Model_Management ----->
<!-- ----->

<!-- ----->
<!-- ----->
<!-- METAMODEL CLASS: Model ----->
<!-- ----->

<!ELEMENT Model_Management.Model (Foundation.Core.ModelElement.name?,
Foundation.Core.ModelElement.visibility?,
Foundation.Core.ModelElement.isSpecification?,
Foundation.Core.GeneralizableElement.isRoot?,
Foundation.Core.GeneralizableElement.isLeaf?,
Foundation.Core.GeneralizableElement.isAbstract?,
XMI.extension*,
Foundation.Core.ModelElement.namespace?,
Foundation.Core.ModelElement.clientDependency*,
Foundation.Core.ModelElement.constraint*,
Foundation.Core.ModelElement.supplierDependency*,
Foundation.Core.ModelElement.presentation*,
Foundation.Core.ModelElement.targetFlow*,
Foundation.Core.ModelElement.sourceFlow*,
Foundation.Core.ModelElement.templateParameter3*,
Foundation.Core.ModelElement.binding?,
```

```

Foundation.Core.ModelElement.comment*,
Foundation.Core.ModelElement.elementResidence*,
Foundation.Core.ModelElement.templateParameter2*,
Foundation.Core.ModelElement.stereotype?,
Foundation.Core.ModelElement.behavior*,
Foundation.Core.ModelElement.classifierRole*,
Foundation.Core.ModelElement.collaboration*,
Foundation.Core.ModelElement.partition*,
Foundation.Core.ModelElement.elementImport*,
Foundation.Core.GeneralizableElement.generalization*,
Foundation.Core.GeneralizableElement.specialization*,
Model_Management.Package.elementImport*,
Foundation.Core.ModelElement.templateParameter*,
Foundation.Core.ModelElement.taggedValue*,
Foundation.Core.Namespace.ownedElement*)?
>

<!-- METAMODEL CLASS: Package -->

<ELEMENT Model_Management.Package.elementImport
         (Model_Management.ElementImport)* >

<ELEMENT Model_Management.Package (Foundation.Core.ModelElement.name?,
Foundation.Core.ModelElement.visibility?,
Foundation.Core.ModelElement.isSpecification?,
Foundation.Core.GeneralizableElement.isRoot?,
Foundation.Core.GeneralizableElement.isLeaf?,
Foundation.Core.GeneralizableElement.isAbstract?,
XMI.extension*,
Foundation.Core.ModelElement.namespace?,
Foundation.Core.ModelElement.clientDependency*,
Foundation.Core.ModelElement.constraint*,
Foundation.Core.ModelElement.supplierDependency*,
Foundation.Core.ModelElement.presentation*,
Foundation.Core.ModelElement.targetFlow*,
Foundation.Core.ModelElement.sourceFlow*,
Foundation.Core.ModelElement.templateParameter3*,
Foundation.Core.ModelElement.binding?,
Foundation.Core.ModelElement.comment*,
Foundation.Core.ModelElement.elementResidence*,
Foundation.Core.ModelElement.templateParameter2*,
Foundation.Core.ModelElement.stereotype?,
Foundation.Core.ModelElement.behavior*,
Foundation.Core.ModelElement.classifierRole*,
Foundation.Core.ModelElement.collaboration*,
Foundation.Core.ModelElement.partition*,
Foundation.Core.ModelElement.elementImport*,
Foundation.Core.GeneralizableElement.generalization*,
Foundation.Core.GeneralizableElement.specialization*,
Model_Management.Package.elementImport*,
Foundation.Core.ModelElement.templateParameter*,
Foundation.Core.ModelElement.taggedValue*,
Foundation.Core.Namespace.ownedElement*)?
>

<!-- METAMODEL CLASS: Package -->

```

6 UML XMI DTD Specification

```
<!-- -->
<!-- METAMODEL CLASS: Subsystem -->
<!-- ----- -->

<!ELEMENT Model_Management.Subsystem.isInstantiable EMPTY >
<!ATTLIST Model_Management.Subsystem.isInstantiable
    xmi.value ( true | false ) #REQUIRED
>

<!ELEMENT Model_Management.Subsystem ( Foundation.Core.ModelElement.name?,
    Foundation.Core.ModelElement.visibility?,
    Foundation.Core.ModelElement.isSpecification?,
    Foundation.Core.GeneralizableElement.isRoot?,
    Foundation.Core.GeneralizableElement.isLeaf?,
    Foundation.Core.GeneralizableElement.isAbstract?,
    Model_Management.Subsystem.isInstantiable?,
    XMI.extension*,
    Foundation.Core.ModelElement.namespace?,
    Foundation.Core.ModelElement.clientDependency*,
    Foundation.Core.ModelElement.constraint*,
    Foundation.Core.ModelElement.supplierDependency*,
    Foundation.Core.ModelElement.presentation*,
    Foundation.Core.ModelElement.targetFlow*,
    Foundation.Core.ModelElement.sourceFlow*,
    Foundation.Core.ModelElement.templateParameter3*,
    Foundation.Core.ModelElement.binding?,
    Foundation.Core.ModelElement.comment*,
    Foundation.Core.ModelElement.elementResidence*,
    Foundation.Core.ModelElement.templateParameter2*,
    Foundation.Core.ModelElement.stereotype?,
    Foundation.Core.ModelElement.behavior*,
    Foundation.Core.ModelElement.classifierRole*,
    Foundation.Core.ModelElement.collaboration*,
    Foundation.Core.ModelElement.partition*,
    Foundation.Core.ModelElement.elementImport*,
    Foundation.Core.GeneralizableElement.generalization*,
    Foundation.Core.GeneralizableElement.specialization*,
    Model_Management.Package.elementImport*,
    Foundation.Core.Classifier.participant*,
    Foundation.Core.Classifier.powertypeRange*,
    Foundation.Core.Classifier.instance*,
    Foundation.Core.Classifier.createAction*,
    Foundation.Core.Classifier.classifierRole*,
    Foundation.Core.Classifier.collaboration*,
    Foundation.Core.Classifier.classifierInState*,
    Foundation.Core.Classifier.objectFlowState*,
    Foundation.Core.ModelElement.templateParameter*,
    Foundation.Core.ModelElement.taggedValue*,
    Foundation.Core.Namespace.ownedElement*,
    Foundation.Core.Classifier.feature*)?
>

<!ATTLIST Model_Management.Subsystem
    %XMI.element.att;
    %XMI.link.att;
>

<!-- ----- -->
<!-- -->
<!-- METAMODEL CLASS: ElementImport -->
<!-- ----- -->

<!ELEMENT Model_Management.ElementImport.visibility EMPTY >
<!ATTLIST Model_Management.ElementImport.visibility
    xmi.value ( public | private | protected ) #REQUIRED
>
```

```

<!ELEMENT Model_Management.ElementImport.alias (#PCDATA |
                                         XMI.reference)* >

<!ELEMENT Model_Management.ElementImport.modelElement (Foundation.Core.ModelElement |
    Foundation.Core.Comment |
    Foundation.Core.Relationship |
    Behavioral_Elements.Use_Cases.Extend |
    Behavioral_Elements.Use_Cases.Include |
    Foundation.Core.Generalization |
    Foundation.Core.Flow |
    Foundation.Core.Association |
    Foundation.Core.AssociationClass |
    Behavioral_Elements.Collaborations.AssociationRole |
    Foundation.Core.Dependency |
    Foundation.Core.Abstraction |
    Foundation.Core.Usage |
    Foundation.Core.Binding |
    Foundation.Core.Permission |
    Foundation.Extension_Mechanisms.TaggedValue |
    Behavioral_Elements.Common_Behavior.Instance |
    Behavioral_Elements.Common_Behavior.Object |
    Behavioral_Elements.Common_Behavior.LinkObject |
    Behavioral_Elements.Common_Behavior.DataValue |
    Behavioral_Elements.Common_Behavior.ComponentInstance |
    Behavioral_Elements.Common_Behavior.NodeInstance |
    Behavioral_Elements.Use_Cases.UseCaseInstance |
    Behavioral_Elements.Common_Behavior.Action |
    Behavioral_Elements.Common_Behavior.CallAction |
    Behavioral_Elements.Common_Behavior.SendAction |
    Behavioral_Elements.Common_Behavior.ActionSequence |
    Behavioral_Elements.Common_Behavior.ReturnAction |
    Behavioral_Elements.Common_Behavior.TerminateAction |
    Behavioral_Elements.Common_Behavior.DestroyAction |
    Behavioral_Elements.Common_Behavior.UninterpretedAction |
    Behavioral_Elements.Common_Behavior.AttributeLink |
    Behavioral_Elements.Common_Behavior.Argument |
    Behavioral_Elements.Common_Behavior.Link |
    Behavioral_Elements.Common_Behavior.LinkEnd |
    Behavioral_Elements.Common_Behavior.Stimulus |
    Behavioral_Elements.Use_Cases.ExtensionPoint |
    Behavioral_Elements.State_Machines.StateMachine |
    Behavioral_Elements.Activity_Graphs.ActivityGraph |
    Behavioral_Elements.State_Machines.Event |
    Behavioral_Elements.State_Machines.TimeEvent |
    Behavioral_Elements.State_Machines.CallEvent |
    Behavioral_Elements.State_Machines.SignalEvent |
    Behavioral_Elements.State_Machines.ChangeEvent |
    Behavioral_Elements.State_Machines.Transition |
    Behavioral_Elements.State_Machines.StateVertex |
    Behavioral_Elements.State_Machines.Pseudostate |
    Behavioral_Elements.State_Machines.SynchState |
    Behavioral_Elements.State_Machines.StubState |
    Behavioral_Elements.State_Machines.State |
    Behavioral_Elements.State_Machines.CompositeState |
    Behavioral_Elements.State_Machines.SubmachineState |
    Behavioral_Elements.Activity_Graphs.SubactivityState |
    Behavioral_Elements.State_Machines.SimpleState |
    Behavioral_Elements.Activity_Graphs.ObjectFlowState |
    Behavioral_Elements.Activity_Graphs.ActionState |
    Behavioral_Elements.Activity_Graphs.CallState |
    Behavioral_Elements.State_Machines.FinalState |
    Behavioral_Elements.State_Machines.Guard |
    Behavioral_Elements.Collaborations.Message |
    Behavioral_Elements.Collaborations.Interaction |
    Behavioral_Elements.Activity_Graphs.Partition |
    Foundation.Core.Feature |
    Foundation.Core.BehavioralFeature |

```

6 UML XMI DTD Specification

```
Behavioral_Elements.Common_Behavior.Reception |
Foundation.Core.Operation |
Foundation.Core.Method |
Foundation.Core.StructuralFeature |
Foundation.Core.Attribute |
Foundation.Core.GeneralizableElement |
Foundation.Extension_Mechanisms.Stereotype |
Behavioral_Elements.Collaborations.Collaboration |
Model_Management.Package |
Model_Management.Subsystem |
Model_Management.Model |
Foundation.Core.Classifier |
Foundation.Core.Class |
Foundation.Core.DataType |
Foundation.Core.Interface |
Foundation.Core.Component |
Foundation.Core.Node |
Behavioral_Elements.Common_Behavior.Signal |
Behavioral_Elements.Common_Behavior.Exception |
Behavioral_Elements.Use_Cases.UseCase |
Behavioral_Elements.Use_Cases.Actor |
Behavioral_Elements.Collaborations.ClassifierRole |
Behavioral_Elements.Activity_Graphs.ClassifierInState |
Foundation.Core.AssociationEnd |
Behavioral_Elements.Collaborations.AssociationEndRole |
Foundation.Core.Namespace |
Foundation.Core.Parameter |
Foundation.Core.Constraint)?
>

<!ELEMENT Model_Management.ElementImport.package (Model_Management.Package |
Model_Management.Subsystem |
Model_Management.Model)?
>

<!ELEMENT Model_Management.ElementImport (Model_Management.ElementImport.visibility?,
Model_Management.ElementImport.alias?,
XMI.extension*,
Model_Management.ElementImport.modelElement?,
Model_Management.ElementImport.package)?
>

<!ATTLIST Model_Management.ElementImport
%XMI.element.att;
%XMI.link.att;
>

<!ELEMENT Model_Management ((Model_Management.Model |
Model_Management.Package |
Model_Management.Subsystem |
Model_Management.ElementImport)* ) >

<!ATTLIST Model_Management
%XMI.element.att;
%XMI.link.att;
>
```

Object Constraint Language Specification 7

This chapter introduces and defines the Object Constraint Language (OCL), a formal language used to express constraints. Users of the Unified Modeling Language and other languages can use OCL to specify constraints and other expressions attached to their models.

Contents

| | |
|---------------------------------------|------|
| 7.1 Overview | 7-3 |
| 7.2 Introduction | 7-4 |
| 7.3 Connection with the UML Metamodel | 7-5 |
| 7.4 Basic Values and Types | 7-7 |
| 7.5 Objects and Properties | 7-11 |
| 7.6 Collection Operations | 7-21 |
| 7.7 The Standard OCL Package | 7-26 |
| 7.8 Predefined OCL Types | 7-27 |
| 7.9 Grammar | 7-47 |

7 Object Constraint Language Specification

7.1 Overview

This chapter introduces and defines the Object Constraint Language (OCL), a formal language used to express constraints. These typically specify invariant conditions that must hold for the system being modeled. Note that when the OCL expressions are evaluated, they do not have side effects; i.e., their evaluation cannot alter the state of the corresponding executing system. In addition, to specifying invariants of the UML metamodel, UML modelers can use OCL to specify application-specific constraints in their models.

OCL is used in the UML Semantics chapter to specify the well-formedness rules of the metaclasses comprising the UML metamodel. A well-formedness rule in the static semantics chapters in the UML Semantics section normally contains an OCL expression, specifying an invariant for the associated metaclass. The grammar for OCL is specified at the end of this chapter. A parser generated from this grammar has correctly parsed all the constraints in the UML Semantics section, a process which improved the correctness of the specifications for OCL and UML.

7.1.1 Why OCL?

A UML diagram, such as a class diagram, is typically not refined enough to provide all the relevant aspects of a specification. There is, among other things, a need to describe additional constraints about the objects in the model. Such constraints are often described in natural language. Practice has shown that this will always result in ambiguities. In order to write unambiguous constraints, so-called formal languages have been developed. The disadvantage of traditional formal languages is that they are usable to persons with a string mathematical background, but difficult for the average business or system modeler to use.

OCL has been developed to fill this gap. It is a formal language that remains easy to read and write. It has been developed as a business modeling language within the IBM Insurance division, and has its roots in the Syntropy method.

OCL is a pure expression language; therefore, an OCL expression is guaranteed to be without side effect. When an OCL expression is evaluated, it simply returns a value. It cannot change anything in the model. This means that the state of the system will never change because of the evaluation of an OCL expression, even though an OCL expression can be used to *specify* a state change (e.g., in a post-condition).

OCL is not a programming language; therefore, it is not possible to write program logic or flow control in OCL. You cannot invoke processes or activate non-query operations within OCL. Because OCL is a modeling language in the first place, not everything in it is promised to be directly executable.

OCL is a typed language, so that each OCL expression has a type. To be well formed, an OCL expression must conform to the type conformance rules of the language. For example, you cannot compare an Integer with a String. Each Classifier defined within a UML model represents a distinct OCL type. In addition, OCL includes a set of supplementary predefined types (these are described in the section on Predefined OCL Types on page 27).

7 Object Constraint Language Specification

As a specification language, all implementation issues are out of scope and cannot be expressed in OCL.

The evaluation of an OCL expression is instantaneous. This means that the states of objects in a model cannot change during evaluation.

7.1.2 Where to Use OCL

OCL can be used for a number of different purposes:

- To specify invariants on classes and types in the class model
- To specify type invariant for Stereotypes
- To describe pre- and post conditions on Operations and Methods
- To describe Guards
- As a navigation language
- To specify constraints on operations

Within the UML Semantics chapter, OCL is used in the well-formedness rules as invariants on the metaclasses in the abstract syntax. In several places, it is also used to define 'additional' operations which are used in the well-formedness rules.

7.2 Introduction

7.2.1 Legend

Text written in the courier typeface as shown below is an OCL expression.

```
'This is an OCL expression'
```

The *context* keyword introduces the context for the expression. The keyword *inv*, *pre* and *post* denote the stereotypes, respectively «invariant», «precondition», and «postcondition», of the constraint. The actual OCL expression comes after the colon.

```
context TypeName inv:  
'this is an OCL expression with stereotype <<invariant>> in the  
context of TypeName' = 'another string'
```

In the examples, the keywords of OCL are written in boldface in this document. The boldface has no formal meaning, but is used to make the expressions more readable in this document. OCL expressions are written using ASCII characters only.

Words in *Italics* within the main text of the paragraphs refer to parts of OCL expressions.

7.2.2 Example Class Diagram

The diagram below is used in the examples in this document.

7.3 Connection with the UML Metamodel

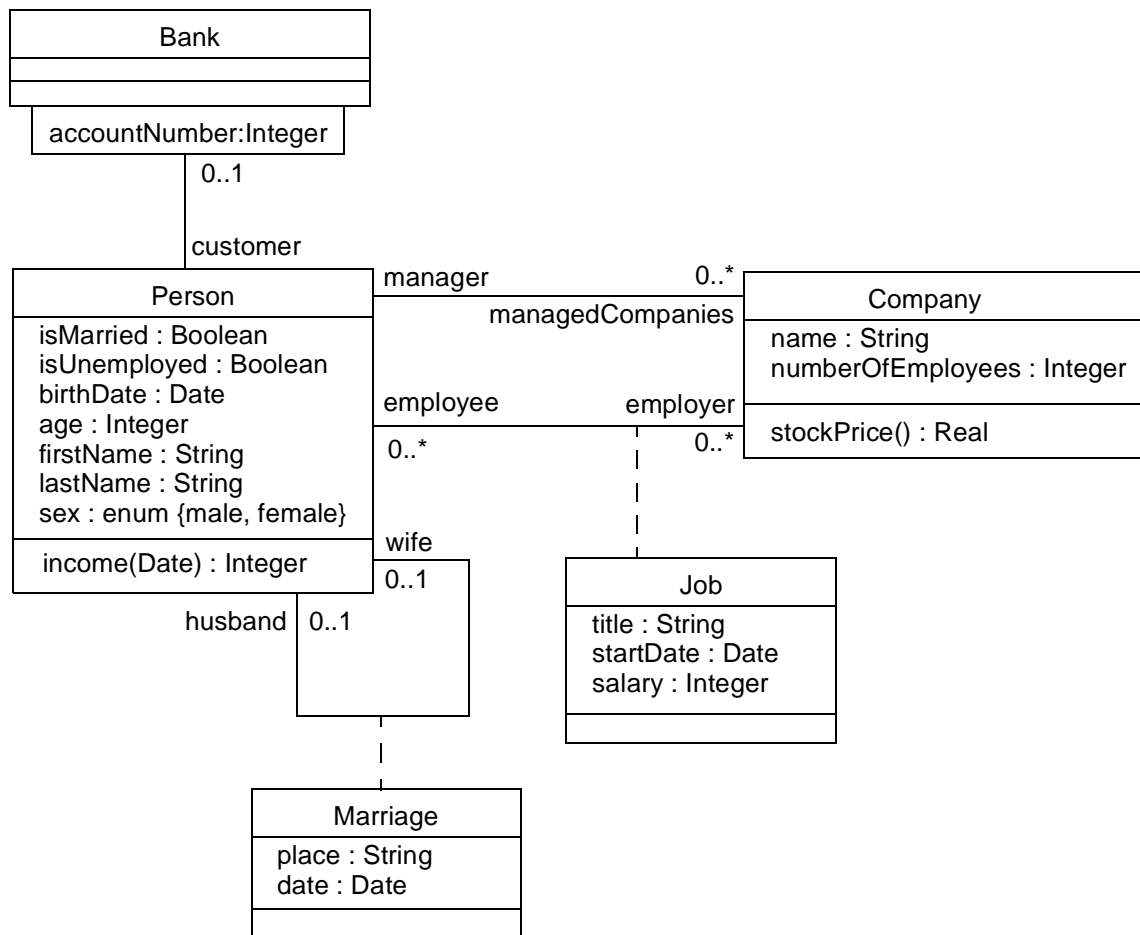

Figure 7-1 Class Diagram Example

7.3 Connection with the UML Metamodel

7.3.1 Self

Each OCL expression is written in the context of an instance of a specific type. In an OCL expression, the reserved word *self* is used to refer to the contextual instance. For instance, if the context is *Company*, then *self* refers to an instance of *Company*.

7.3.2 Specifying the UML context

The context of an OCL expression within a UML model can be specified through a so-called context declaration at the beginning of an OCL expression. The context declaration of the constraints in the following sections is shown.

7 Object Constraint Language Specification

If the constraint is shown in a diagram, with the proper stereotype and the dashed lines to connect it to its contextual element, there is no need for an explicit context declaration in the test of the constraint. The context declaration is optional.

7.3.3 Invariants

The OCL expression can be part of an Invariant which is a Constraint stereotyped as an «invariant». When the invariant is associated with a Classifier, the latter is referred to as a “type” in this chapter. An OCL expression is an invariant of the type and must be true for all instances of that type at any time. (Note that all OCL expressions that express invariants are of the type Boolean.)

For example, if in the context of the Company type in Figure 7-1, the following expression would specify an invariant that the number of employees must always exceed 50:

```
self.numberOfEmployees > 50
```

where *self* is an instance of type Company. (We can view *self* as the object from where we start the expression.) This invariant holds for every instance of the Company type.

The type of the contextual instance of an OCL expression, which is part of an invariant, is written with the *context* keyword, followed by the name of the type as follows. The label *inv:* declares the constraint to be an «invariant» constraint.

```
context Company inv:  
    self.numberOfEmployees > 50
```

In most cases, the keyword *self* can be dropped because the context is clear, as in the above examples. As an alternative for *self*, a different name can be defined playing the part of *self*:

```
context c : Company inv:  
    c.numberOfEmployees > 50
```

This invariant is equivalent to the previous one.

Optionally, the name of the constraint may be written after the *inv* keyword, allowing the constraint to be referenced by name. In the following example the name of the constraint is *enoughEmployees*. In the UML metamodel, this name is an attribute of the metaclass Constraint that is inherited from ModelElement.

```
context c : Company inv enoughEmployees:  
    c.numberOfEmployees > 50
```

7.3.4 Pre- and Postconditions

The OCL expression can be part of a Precondition or Postcondition, corresponding to «precondition» and «postcondition» stereotypes of Constraint associated with an Operation or Method. The contextual instance *self* then is an instance of the type which owns the operation or method as a feature. The context declaration in OCL uses the *context* keyword, followed by the type and operation declaration. The stereotype of constraint is shown by putting the labels ‘pre:’ and ‘post:’ before the actual Preconditions and Postconditions

7.4 Basic Values and Types

```
context Typename::operationName(param1 : Type1, ... ): ReturnType
pre : param1 > ...
post: result = ...
```

The name *self* can be used in the expression referring to the object on which the operation was called. The reserved word *result* denotes the result of the operation, if there is one. The names of the parameters (*param1*) can also be used in the OCL expression. In the example diagram, we can write:

```
context Person::income(d : Date) : Integer
post: result = 5000
```

Optionally, the name of the precondition or postcondition may be written after the *pre* or *post* keyword, allowing the constraint to be referenced by name. In the following example the name of the precondition is *parameterOk* and the name of the postcondition is *resultOk*. In the UML metamodel, these names are attributes of the metaclass *Constraint* that is inherited from *ModelElement*.

```
context Typename::operationName(param1 : Type1, ... ): ReturnType
pre parameterOk: param1 > ...
post resultOk: result = ...
```

7.3.5 General Expressions

Any OCL expression can be used as the value for an attribute of the UML metaclass *Expression* or one of its subtypes. In that case, the semantics section describes the meaning of the expression.

7.4 Basic Values and Types

In OCL, a number of basic types are predefined and available to the modeler at all time. These predefined value types are independent of any object model and part of the definition of OCL.

The most basic value in OCL is a value of one of the basic types. Some basic types used in the examples in this document, with corresponding examples of their values, are shown in Table 7-1.

| type | values |
|---------|--------------------------|
| Boolean | true, false |
| Integer | 1, -5, 2, 34, 26524, ... |
| Real | 1.5, 3.14, ... |
| String | 'To be or not to be...' |

Table 7-1 Basic types

7 Object Constraint Language Specification

OCL defines a number of operations on the predefined types. Table 7-2 gives some examples of the operations on the predefined types. See “Predefined OCL Types” on page 7-27 for a complete list of all operations.

| type | operations |
|---------|--|
| Integer | *, +, -, /, abs |
| Real | *, +, -, /, floor |
| Boolean | and, or, xor, not, implies, if-then-else |
| String | toUpper, concat |

Table 7-2 Operations on predefined types

The complete list of operations provided for each type is described at the end of this chapter. Collection, Set, Bag and Sequence are basic types as well. Their specifics will be described in the upcoming sections.

7.4.1 Types from the UML Model

Each OCL expression is written in the context of a UML model, a number of classifiers (types/classes, ...), their features and associations, and their generalizations. All classifiers from the UML model are types in the OCL expressions that are attached to the model.

7.4.2 Enumeration Types

As shown in the example diagram, new enumeration types can be defined in a model by using:

```
enum{ value1, value2, value3 }
```

The values of the enumeration can be used within expressions.

As there might be a name conflict with attribute names being equal to enumeration values, the usage of an enumeration value is expressed syntactically with an additionalpound (#) symbol prefixing the name of the value:

```
#value1
```

The type of an enumeration attribute is Enumeration, with restrictions on the values for the attribute.

7.4.3 Let Expression

Sometimes a sub-expression is used more than once in a constraint. The *let* expression allows one to define a variable which can be used in the constraint.

```
context Person inv:  
  let income : Integer = self.job.salary->sum in  
  if isUnemployed then  
    income < 100  
  else
```

```

income >= 100
endif
    
```

7.4.4 Type Conformance

OCL is a typed language and the basic value types are organized in a type hierarchy. This hierarchy determines conformance of the different types to each other. You cannot, for example, compare an Integer with a Boolean or a String.

An OCL expression in which all the types conform is a valid expression. An OCL expression in which the types don't conform is an invalid expression. It contains a type *conformance error*. A type *type1* conforms to a type *type2* when an instance of *type1* can be substituted at each place where an instance of *type2* is expected. The type conformance rules for types in the class diagrams are simple.

- Each type conforms to each of its supertypes.
- Type conformance is transitive: if *type1* conforms to *type2*, and *type2* conforms to *type3*, then *type1* conforms to *type3*.

The effect of this is that a type conforms to its supertype, and all the supertypes above. The type conformance rules for the value types are listed in Table 7-3.

| Type | Conforms to/Is a subtype of |
|-------------|-----------------------------|
| Set(T) | Collection(T) |
| Sequence(T) | Collection(T) |
| Bag(T) | Collection(T) |
| Integer | Real |

Table 7-3 Type conformance rules

The conformance relation between the collection types only holds if they are collections of element types that conform to each other. See “Collection Type Hierarchy and Type Conformance Rules” on page 7-20 for the complete conformance rules for collections.

Table 7-4 provides examples of valid and invalid expressions.

| OCL expression | valid | explanation |
|------------------|-------|--|
| 1 + 2 * 34 | yes | |
| 1 + 'motorcycle' | no | type Integer does not conform to type String |
| 23 * false | no | type Integer does not conform to Boolean |
| 12 + 13.5 | yes | |

Table 7-4 Valid expressions

7 Object Constraint Language Specification

7.4.5 Re-typing or Casting

In some circumstances, it is desirable to use a property of an object that is defined on a subtype of the current known type of the object. Because the property is not defined on the current known type, this results in a type conformance error.

When it is certain that the actual type of the object is the subtype, the object can be re-typed using the operation *oclAsType(OclType)*. This operation results in the same object, but the known type is the argument *OclType*. When there is an object *object* of type *Type1* and *Type2* is another type, it is allowed to write:

```
object.oclAsType(Type2) --- evaluates to object with type Type2
```

An object can only be re-typed to one of its subtype; therefore, in the example, *Type2* must be a subtype of *Type1*.

If the actual type of the object is not a subtype of the type to which it is re-typed, the expression is undefined (see “Undefined Values” on page 7-11).

7.4.6 Precedence Rules

The precedence order for the operations, starting with highest precedence, in OCL is:

- @pre
- dot and arrow operations: ‘.’ and ‘->’
- unary ‘not’ and unary minus ‘-’
- ‘*’ and ‘/’
- ‘+’ and binary ‘-’
- ‘if-then-else-endif’
- ‘<’, ‘>’, ‘<=’, ‘>=’
- ‘=’, ‘<>’
- ‘and’, ‘or’ and ‘xor’
- ‘implies’

Parentheses ‘(’ and ‘)’ can be used to change precedence.

7.4.7 Use of Infix Operators

The use of infix operators is allowed in OCL. The operators ‘+’, ‘-’, ‘*’, ‘/’, ‘<’, ‘>’, ‘<>’, ‘<=’, ‘>=’ are used as infix operators. If a type defines one of those operators with the correct signature, they will be used as infix operators. The expression:

```
a + b
```

is conceptually equal to the expression:

```
a.+(b)
```

that is, invoking the ‘+’ operation on a with b as the parameter to the operation.

The infix operators defined for a type must have exactly one parameter. For the infix operators '<', '>', '<=', '>=', '<>', 'and', 'or', and 'xor' the return type must be Boolean.

7.4.8 Comment

Comments in OCL are written following two successive dashes (minus signs). Everything immediately following the two dashes up to and including the end of line is part of the comment. For example:

```
-- this is a comment
```

7.4.9 Undefined Values

Whenever an OCL expression is being evaluated, there is a possibility that one or more of the queries in the expression are undefined. If this is the case, then the complete expression will be undefined.

There are two exceptions to this for the Boolean operators:

- True OR-ed with anything is True
- False AND-ed with anything is False

The above two rules are valid irrespective of the order of the arguments and the above rules are valid whether or not the value of the other sub-expression is known.

7.5 Objects and Properties

OCL expressions can refer to Classifiers, e.g. types, classes, interfaces, associations (acting as types) and datatypes. Also all attributes, association-ends, methods, and operations without side-effects that are defined on these types, etc. can be used. In a class model, an operation or method is defined to be side-effect-free if the *isQuery* attribute of the operations is true. For the purpose of this document, we will refer to attributes, association-ends, and side-effect-free methods and operations as being *properties*. A property is one of:

- an Attribute
- an AssociationEnd
- an Operation with *isQuery* being true
- a Method with *isQuery* being true

7.5.1 Properties

The value of a property on an object that is defined in a class diagram is specified by a dot followed by the name of the property.

```
context AType inv:  
    self.property
```

If *self* is a reference to an object, then *self.property* is the value of the *property* property on *self*.

7 Object Constraint Language Specification

7.5.2 Properties: Attributes

For example, the age of a Person is written as *self.age*:

```
context Person inv:  
    self.age > 0
```

The value of the subexpression *self.age* is the value of the *age* attribute on the particular instance of Person identified by *self*. The type of this subexpression is the type of the attribute *age*, which is the basic type Integer.

Using attributes, and operations defined on the basic value types, we can express calculations etc. over the class model. For example, a business rule might be “the age of a Person is always greater than zero.” This can be stated as shown in the invariant above.

7.5.3 Properties: Operations

Operations may have parameters. For example, as shown earlier, a Person object has an income expressed as a function of the date. This operation would be accessed as follows, for a Person *aPerson* and a date *aDate*:

```
aPerson.income(aDate)
```

The operation itself could be defined by a postcondition constraint. This is a constraint that is stereotyped as «postcondition». The object that is returned by the operation can be referred to by *result*. It takes the following form:

```
context Person::income (d: Date) : Integer  
    post: result = age * 1000
```

The right-hand-side of this definition may refer to the operation being defined (i.e., the definition may be recursive) as long as the recursion is not infinite. The type of *result* is the return type of the operation, which is Integer in the above example.

To refer to an operation or a method that doesn't take a parameter, parentheses with an empty argument list are mandatory:

```
context Company inv:  
    self.stockPrice() > 0
```

7.5.4 Properties: Association Ends and Navigation

Starting from a specific object, we can navigate an association on the class diagram to refer to other objects and their properties. To do so, we navigate the association by using the opposite association-end:

```
object.rolename
```

The value of this expression is the set of objects on the other side of the *rolename* association. If the multiplicity of the association-end has a maximum of one (“0..1” or “1”), then the value of this expression is an object. In the example class diagram, when we start in the context of a Company (i.e., *self* is an instance of Company), we can write:

```
context Company
```

```
inv: self.manager.isUnemployed = false
inv: self.employee->notEmpty
```

In the first invariant *self.manager* is a Person, because the multiplicity of the association is one. In the second invariant *self.employee* will evaluate in a Set of Persons. By default, navigation will result in a Set. When the association on the Class Diagram is adorned with {ordered}, the navigation results in a Sequence.

Collections, like Sets, Bags, and Sequences are predefined types in OCL. They have a large number of predefined operations on them. A property of the collection itself is accessed by using an arrow ‘->’ followed by the name of the property. The following example is in the context of a person:

```
context Person inv:
    self.employer->size < 3
```

This applies the *size* property on the Set *self.employer*, which results in the number of employers of the Person *self*.

```
context Person inv:
    self.employer->isEmpty
```

This applies the *isEmpty* property on the Set *self.employer*. This evaluates to true if the set of employers is empty and false otherwise.

Missing Rolenames

When a rolename is missing at one of the ends of an association, the name of the type at the association end, starting with a lowercase character, is used as the rolename. If this results in an ambiguity, the rolename is mandatory. This is the case with unnamed rolenames in reflexive associations. If the rolename is ambiguous, then it cannot be used in OCL.

Navigation over Associations with Multiplicity Zero or One

Because the multiplicity of the role manager is one, *self.manager* is an object of type Person. Such a single object can be used as a Set as well. It then behaves as if it is a Set containing the single object. The usage as a set is done through the arrow followed by a property of Set. This is shown in the following example:

```
context Company inv:
    self.manager->size = 1
```

The sub-expression *self.manager* is used as a Set, because the arrow is used to access the *size* property on Set. This expression evaluates to true

```
context Company inv:
    self.manager->foo
```

The sub-expression *self.manager* is used as Set, because the arrow is used to access the *foo* property on the Set. This expression is incorrect, because *foo* is not a defined property of Set.

```
context Company inv:
    self.manager.age > 40
```

7 Object Constraint Language Specification

The sub-expression *self.manager* is used as a Person, because the dot is used to access the *age* property of Person.

In the case of an optional (0..1 multiplicity) association, this is especially useful to check whether there is an object or not when navigating the association. In the example we can write:

```
context Person inv:
    self.wife->notEmpty implies self.wife.sex = #female
```

Combining Properties

Properties can be combined to make more complicated expressions. An important rule is that an OCL expression always evaluates to a specific object of a specific type. After obtaining a result, one can always apply another property to the result to get a new result value. Therefore, each OCL expression can be read and evaluated left-to-right.

Following are some invariants that use combined properties on the example class diagram:

[1] Married people are of age ≥ 18

```
context Person inv:
    self.wife->notEmpty implies self.wife.age  $\geq 18$  and
    self.husband->notEmpty implies self.husband.age  $\geq 18$ 
```

[2] a company has at most 50 employees

```
context Company inv:
    self.employee->size  $\leq 50$ 
```

7.5.5 Navigation to Association Classes

To specify navigation to association classes (Job and Marriage in the example), OCL uses a dot and the name of the association class starting with a lowercase character:

```
context Person inv:
    self.job
```

The sub-expression *self.job* evaluates to a Set of all the jobs a person has with the companies that are his/her employer. In the case of an association class, there is no explicit rolename in the class diagram. The name *job* used in this navigation is the name of the association class starting with a lowercase character, similar to the way described in the section “Missing Rolenames” above.

In case of a recursive association, that is an association of a class with itself, the name of the association class alone is not enough. We need to distinguish the direction in which the association is navigated as well as the name of the association class. Take the following model as an example.

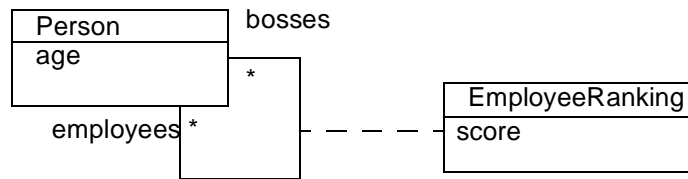

Figure 7-2 Navigating recursive association classes

When navigating to an association class such as *employeeRanking* there are two possibilities depending on the direction. For instance, in the above example, we may navigate towards the *employees* end, or the *bosses* end. By using the name of the association class alone, these two options cannot be distinguished. To make the distinction, the rolename of the direction in which we want to navigate is added to the association class name, enclosed in square brackets. In the expression

```

context Person inv:
    self.employeeRanking[bosses]->sum > 0
  
```

the *self.employeeRanking[bosses]* evaluates to the set of *EmployeeRankings* belonging to the collection of *bosses*. And in the expression

```

context Person inv:
    self.employeeRanking[employees]->sum > 0
  
```

the *self.employeeRanking[employees]* evaluates to the set of *EmployeeRankings* belonging to the collection of *employees*. The unqualified use of the association class name is not allowed in such a recursive situation. Thus, the following example is invalid:

```

context Person inv:
    self.employeeRanking->sum > 0 -- INVALID!
  
```

In a non-recursive situation, the association class name alone is enough, although the qualified version is allowed as well. Therefore, the examples at the start of this section could also be written as:

```

context Person inv:
    self.job[employer]
  
```

7.5.6 Navigation from Association Classes

We can navigate from the association class itself to the objects that participate in the association. This is done using the dot-notation and the role-names at the association-ends.

```

context Job
    inv: self.employer.numberOfEmployees >= 1
    inv: self.employee.age > 21
  
```

7 Object Constraint Language Specification

Navigation from an association class to one of the objects on the association will always deliver exactly one object. This is a result of the definition of AssociationClass. Therefore, the result of this navigation is exactly one object, although it can be used as a Set using the arrow (->).

7.5.7 Navigation through Qualified Associations

Qualified associations use one or more qualifier attributes to select the objects at the other end of the association. To navigate them, we can add the values for the qualifiers to the navigation. This is done using square brackets, following the role-name. It is permissible to leave out the qualifier values, in which case the result will be all objects at the other end of the association.

```
context Bank inv:
    self.customer
```

This results in a Set(Person) containing all customers of the Bank.

```
context Bank inv:
    self.customer[8764423]
```

This results in one Person, having accountnumber 8764423.

If there is more than one qualifier attribute, the values are separated by commas, in the order which is specified in the UML class model. It is not permissible to partially specify the qualifier attribute values.

7.5.8 Using Pathnames for Packages

Within UML, different types are organized in packages. OCL provides a way of explicitly referring to types in other packages by using a package-pathname prefix. The syntax is a package name, followed by a double colon:

```
Packagename::Typename
```

This usage of pathnames is transitive and can also be used for packages within packages:

```
Packagename1::Packagename2::Typename
```

7.5.9 Accessing overridden properties of supertypes

Whenever properties are redefined within a type, the property of the supertypes can be accessed using the *oclAsType()* operation. Whenever we have a class B as a subtype of class A, and a property p1 of both A and B, we can write:

```
context B inv:
    self.oclAsType(A).p1 -- accesses the p1 property defined in A
    self.p1              -- accesses the p1 property defined in B
```

Figure 7-3 shows an example where such a construct is needed.

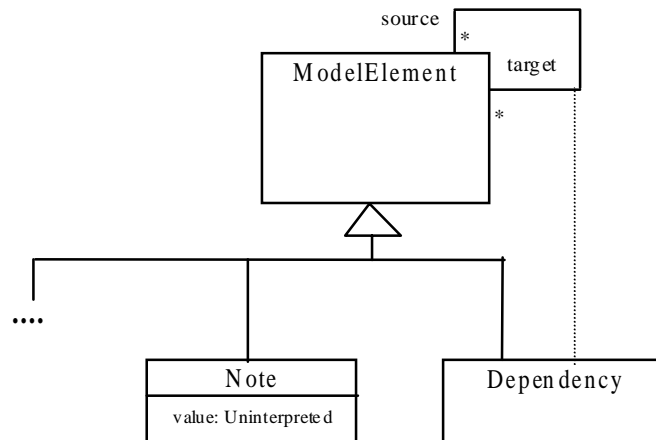

Figure 7-3 Accessing Overridden Properties Example

In this model fragment there is an ambiguity with the OCL expression on Dependency:

```

context Dependency inv:
  self.source <> self
  
```

This can either mean normal association navigation, which is inherited from ModelElement, or it might also mean navigation through the dotted line as an association class. Both possible navigations use the same role-name, so this is always ambiguous. Using *oclAsType()* we can distinguish between them with:

```

context Dependency
  inv: self.oclAsType(Dependency).source
  inv: self.oclAsType(ModelElement).source
  
```

7.5.10 Predefined properties on All Objects

There are several properties that apply to all objects, and are predefined in OCL. These are:

```

oclIsTypeOf(t : OclType)      : Boolean
oclIsKindOf(t : OclType)      : Boolean
oclInState(s : OclState)      : Boolean
oclIsNew                       : Boolean
oclAsType(t : OclType) : instance of OclType
  
```

The operation *oclTypeOf* results in true if the *type* of self and *t* are the same. For example:

```

context Person
  inv: self.oclIsTypeOf( Person )      -- is true
  inv: self.oclIsTypeOf( Company)     -- is false
  
```

The above property deals with the direct type of an object. The *oclIsKindOf* property determines whether *t* is either the direct type or one of the supertypes of an object.

7 Object Constraint Language Specification

The operation *oclInState* results in true if the object is in the state *s*. Values for *s* are the names of the states in the statemachine(s) attached to the Classifier of *object*. For nested states the statenames can be combined using the ::.

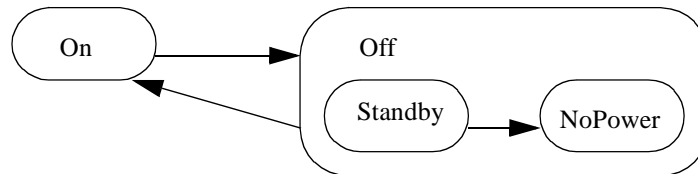

In the example statemachine above, values for *s* can be *On*, *Off*, *Off::Standby*, *Off::NoPower*. If the classifier of *object* has the above associated statemachine valid OCL expressions are:

```
object.oclInState(On)
object.oclInState(Off)
object.oclInState(Off::Standby)
object.oclInState(Off::NoPower)
```

If there are multiple statemachines attached to the object's classifier, then the statename can be prefixed with the name of the statemachine containing the state and the double semicolon ::, as with nested states.

The operation *oclIsNew* evaluates to true if, used in a postcondition, the object is created during performing the operation. i.e., it didn't exist at precondition time.

7.5.11 Features on Classes Themselves

All properties discussed until now in OCL are properties on instances of classes. The types are either predefined in OCL or defined in the class model. In OCL, it is also possible to use features defined on the types/classes themselves. These are, for example, the *class*-scoped features defined in the class model. Furthermore, several features are predefined on each type.

A predefined feature on each type is *allInstances*, which results in the Set of all instances of the type in existence at the specific time when the expression is evaluated. If we want to make sure that all instances of *Person* have unique names, we can write:

```
context Person inv:
    Person.allInstances->forall(p1, p2 |
        p1 <> p2 implies p1.name <> p2.name)
```

The *Person.allInstances* is the set of all persons and is of type *Set(Person)*. It is the set of all persons that exist at the snapshot in time that the expression is evaluated.

NB: The use of *allInstances* has some problems and its use is discouraged in most cases. The first problem is best explained by looking at the types like Integer, Real and String. For these types the meaning of *allInstances* is undefined. What does it mean for an Integer to exist? The evaluation of the expression *Integer.allInstances* results in an infinite set and is therefore undefined within OCL. The second problem with *allInstances* is that the existence of objects must be considered within some overall context, like a system or a model. This overall context must be defined, which is not done within OCL. A recommended style is to model the overall contextual system explicitly as an object within the system and navigate from that object to its containing instances without using *allInstances*.

7.5.12 Collections

Single navigation results in a Set, combined navigations in a Bag, and navigation over associations adorned with {ordered} results in a Sequence. Therefore, the collection types play an important role in OCL expressions.

The type Collection is predefined in OCL. The Collection type defines a large number of predefined operations to enable the OCL expression author (the modeler) to manipulate collections. Consistent with the definition of OCL as an expression language, collection operations never change collections; *isQuery* is always true. They may result in a collection, but rather than changing the original collection they project the result into a new one.

Collection is an abstract type, with the concrete collection types as its subtypes. OCL distinguishes three different collection types: Set, Sequence, and Bag. A Set is the mathematical set. It does not contain duplicate elements. A Bag is like a set, which may contain duplicates (i.e., the same element may be in a bag twice or more). A Sequence is like a Bag in which the elements are ordered. Both Bags and Sets have no order defined on them. Sets, Sequences, and Bags can be specified by a literal in OCL. Curly brackets surround the elements of the collection, elements in the collection are written within, separated by commas. The type of the collection is written before the curly brackets:

```
Set { 1 , 2 , 5 , 88 }
Set { 'apple' , 'orange' , 'strawberry' }
```

A Sequence:

```
Sequence { 1, 3, 45, 2, 3 }
Sequence { 'ape', 'nut' }
```

A bag:

```
Bag {1 , 3 , 4, 3, 5 }
```

Because of the usefulness of a Sequence of consecutive Integers, there is a separate literal to create them. The elements inside the curly brackets can be replaced by an interval specification, which consists of two expressions of type Integer, *Int-expr1* and *Int-expr2*, separated by '..'. This denotes all the Integers between the values of *Int-expr1* and *Int-expr2*, including the values of *Int-expr1* and *Int-expr2* themselves:

```
Sequence{ 1..(6 + 4) }
Sequence{ 1..10 }
-- are both identical to
```

7 Object Constraint Language Specification

```
Sequence{ 1, 2, 3, 4, 5, 6, 7, 8, 9, 10 }
```

The complete list of Collection operations is described at the end of this chapter.

Collections can be specified by a literal, as described above. The only other way to get a collection is by navigation. To be more precise, the only way to get a Set, Sequence, or Bag is:

1. a literal, this will result in a Set, Sequence, or Bag:

```
Set      {1 , 2, 3 , 5 , 7 , 11, 13, 17 }
Sequence {1 , 2, 3 , 5 , 7 , 11, 13, 17 }
Bag      {1, 2, 3, 2, 1}
```

2. a navigation starting from a single object can result in a collection:

```
Company
  self.employee
```

3. operations on collections may result in new collections:

```
collection1->union(collection2)
```

7.5.13 Collections of Collections

Within OCL, all Collections of Collections are flattened automatically; therefore, the following two expressions have the same value:

```
Set{ Set{1, 2}, Set{3, 4}, Set{5, 6} }
Set{ 1, 2, 3, 4, 5, 6 }
```

7.5.14 Collection Type Hierarchy and Type Conformance Rules

In addition to the type conformance rules in “Type Conformance” on page 7-9, the following rules hold for all types, including the collection types:

- The types Set (X), Bag (X) and Sequence (X) are all subtypes of Collection (X).

Type conformance rules are as follows for the collection types:

- *Type1* conforms to *Type2* when they are identical (standard rule for all types).
- *Type1* conforms to *Type2* when it is a subtype of *Type2* (standard rule for all types).
- *Collection(Type1)* conforms to *Collection(Type2)*, when *Type1* conforms to *Type2*.
- Type conformance is transitive: if *Type1* conforms to *Type2*, and *Type2* conforms to *Type3*, then *Type1* conforms to *Type3* (standard rule for all types).

For example, if *Bicycle* and *Car* are two separate subtypes of *Transport*:

```
Set(Bicycle) conforms to Set(Transport)
Set(Bicycle) conforms to Collection(Bicycle)
Set(Bicycle) conforms to Collection(Transport)
```

Note that Set(Bicycle) does not conform to Bag(Bicycle), nor the other way around. They are both subtypes of Collection(Bicycle) at the same level in the hierarchy.

7.5.15 Previous Values in Postconditions

As stated in “Pre- and Postconditions” on page 7-6, OCL can be used to specify pre- and postconditions on Operations and Methods in UML. In a postcondition, the expression can refer to two sets of values for each property of an object:

- the value of a property at the start of the operation or method
- the value of a property upon completion of the operation or method

The value of a property in a postcondition is the value upon completion of the operation. To refer to the value of a property at the start of the operation, one has to postfix the property name with the keyword ‘@pre’:

```
context Person::birthdayHappens()  
post: age = age@pre + 1
```

The property *age* refers to the property of the instance of Person on which executes the operation. The property *age@pre* refers to the value of the property *age* of the Person that executes the operation, at the start of the operation.

If the property has parameters, the ‘@pre’ is postfixed to the propertyname, before the parameters.

```
context Company::hireEmployee(p : Person)  
post: employees = employees@pre->including(p) and  
stockprice() = stockprice@pre() + 10
```

The above operation can also be specified by a postcondition and a precondition together:

```
context Company::hireEmployee(p : Person)  
pre : not employee->includes(p)  
post: employees->includes(p) and  
stockprice() = stockprice@pre() + 10
```

When the pre-value of a property evaluates to an object, all further properties that are accessed of this object are the new values (upon completion of the operation) of this object. So:

```
a.b@pre.c           -- takes the old value of property b of a, say x  
                   -- and then the new value of c of x.  
a.b@pre.c@pre      -- takes the old value of property b of a, say x  
                   -- and then the old value of c of x.
```

The ‘@pre’ postfix is allowed only in OCL expressions that are part of a Postcondition. Asking for a current property of an object that has been destroyed during execution of the operation results in Undefined. Also, referring to the previous value of an object that has been created during execution of the operation results in Undefined.

7.6 Collection Operations

OCL defines many operations on the collection types. These operations are specifically meant to enable a flexible and powerful way of projecting new collections from existing ones. The different constructs are described in the following sections.

7 Object Constraint Language Specification

7.6.1 Select and Reject Operations

Sometimes an expression using operations and navigations delivers a collection, while we are interested only in a special subset of the collection. OCL has special constructs to specify a selection from a specific collection. These are the *select* and *reject* operations. The *select* specifies a subset of a collection. A *select* is an operation on a collection and is specified using the arrow-syntax:

```
collection->select( ... )
```

The parameter of *select* has a special syntax that enables one to specify which elements of the collection we want to select. There are three different forms, of which the simplest one is:

```
collection->select( boolean-expression )
```

This results in a collection that contains all the elements from *collection* for which the *boolean-expression* evaluates to true. To find the result of this expression, for each element in *collection* the expression *boolean-expression* is evaluated. If this evaluates to true, the element is included in the result collection, otherwise not. As an example, the following OCL expression specifies that the collection of all the employees older than 50 years is not empty:

```
context Company inv:  
    self.employee->select(age > 50)->notEmpty
```

The *self.employee* is of type Set(Person). The *select* takes each person from *self.employee* and evaluates *age > 50* for this person. If this results in *true*, then the person is in the result Set.

As shown in the previous example, the context for the expression in the *select* argument is the element of the collection on which the *select* is invoked. Thus the *age* property is taken in the context of a person.

In the above example, it is impossible to refer explicitly to the persons themselves; you can only refer to properties of them. To enable to refer to the persons themselves, there is a more general syntax for the *select* expression:

```
collection->select( v | boolean-expression-with-v )
```

The variable *v* is called the iterator. When the *select* is evaluated, *v* iterates over the *collection* and the *boolean-expression-with-v* is evaluated for each *v*. The *v* is a reference to the object from the collection and can be used to refer to the objects themselves from the *collection*. The two examples below are identical:

```
context Company inv:  
    self.employee->select(age > 50)->notEmpty  
  
context Company inv:  
    self.employee->select(p | p.age > 50)->notEmpty
```

The result of the complete *select* is the collection of persons *p* for which the *p.age > 50* evaluates to True. This amounts to a subset of *self.employee*.

As a final extension to the *select* syntax, the expected type of the variable *v* can be given. The *select* now is written as:

```
collection->select( v : Type | boolean-expression-with-v )
```

The meaning of this is that the objects in *collection* must be of type *Type*. The next example is identical to the previous examples:

```
context Company inv:
    self.employee.select(p : Person | p.age > 50)->notEmpty
```

The complete select syntax now looks like one of:

```
collection->select( v : Type | boolean-expression-with-v )
collection->select( v | boolean-expression-with-v )
collection->select( boolean-expression )
```

The *reject* operation is identical to the select operation, but with reject we get the subset of all the elements of the collection for which the expression evaluates to False. The reject syntax is identical to the select syntax:

```
collection->reject( v : Type | boolean-expression-with-v )
collection->reject( v | boolean-expression-with-v )
collection->reject( boolean-expression )
```

As an example, specify that the collection of all the employees who are **not** married is empty:

```
context Company inv:
    self.employee->reject( isMarried )->isEmpty
```

The reject operation is available in OCL for convenience, because each reject can be restated as a select with the negated expression. Therefore, the following two expressions are identical:

```
collection->reject( v : Type | boolean-expression-with-v )
collection->select( v : Type | not (boolean-expression-with-v) )
```

7.6.2 Collect Operation

As shown in the previous section, the select and reject operations always result in a sub-collection of the original collection. When we want to specify a collection which is derived from some other collection, but which contains different objects from the original collection (i.e., it is not a sub-collection), we can use a *collect* operation. The collect operation uses the same syntax as the select and reject and is written as one of:

```
collection->collect( v : Type | expression-with-v )
collection->collect( v | expression-with-v )
collection->collect( expression )
```

The value of the reject operation is the collection of the results of all the evaluations of *expression-with-v*.

An example: specify the collection of *birthDates* for all employees in the context of a company. This can be written in the context of a Company object as one of:

```
self.employee->collect( birthDate )
self.employee->collect( person | person.birthDate )
self.employee->collect( person : Person | person.birthDate )
```

7 Object Constraint Language Specification

An important issue here is that the resulting collection is not a Set, but a Bag. When more than one employee has the same value for *birthDate*, this value will be an element of the resulting Bag more than once. The Bag resulting from the *collect* operation always has the same size as the original collection.

It is possible to make a Set from the Bag, by using the *asSet* property on the Bag. The following expression results in the Set of different *birthDates* from all employees of a Company:

```
self.employee->collect( birthDate )->asSet
```

Shorthand for Collect

Because navigation through many objects is very common, there is a shorthand notation for the *collect* that makes the OCL expressions more readable. Instead of

```
self.employee->collect(birthdate)
```

we can also write:

```
self.employee.birthdate
```

In general, when we apply a property to a collection of Objects, then it will automatically be interpreted as a *collect* over the members of the collection with the specified property.

For any *propertyname* that is defined as a property on the objects in a collection, the following two expressions are identical:

```
collection.propertyname  
collection->collect(propertyname)
```

and so are these if the property is parameterized:

```
collection.propertyname(par1, par2, ...)  
collection->collect(propertyname(par1, par2, ...))
```

7.6.3 ForAll Operation

Many times a constraint is needed on all elements of a collection. The *forAll* operation in OCL allows specifying a Boolean expression, which must hold for all objects in a collection:

```
collection->forAll( v : Type | boolean-expression-with-v )  
collection->forAll( v | boolean-expression-with-v )  
collection->forAll( boolean-expression )
```

This *forAll* expression results in a Boolean. The result is true if the *boolean-expression-with-v* is true for all elements of *collection*. If the *boolean-expression-with-v* is false for one or more *v* in *collection*, then the complete expression evaluates to false. For example, in the context of a company:

```
context Company  
inv: self.employee->forAll( forename = 'Jack' )  
inv: self.employee->forAll( p | p.forename = 'Jack' )  
inv: self.employee->forAll( p : Person | p.forename = 'Jack' )
```

These invariants evaluate to true if the *forename* feature of each employee is equal to 'Jack.'

The `forall` operation has an extended variant in which more than one iterator is used. Both iterators will iterate over the complete collection. Effectively this is a `forall` on the Cartesian product of the collection with itself.

```
context Company inv:
    self.employee->forall( e1, e2 |
        e1 <> e2 implies e1.forename <> e2.forename)
context Company inv:
    self.employee->forall( e1, e2 : Person |
        e1 <> e2 implies e1.forename <> e2.forename)
```

This expression evaluates to true if the forenames of all employees are different. It is semantically equivalent to:

```
context Company inv:
    self.employee->forall(e1 | self.employee->forall (e2 |
        e1 <> e2 implies e1.forename <> e2.forename)))
```

7.6.4 Exists Operation

Many times one needs to know whether there is at least one element in a collection for which a constraint holds. The *exists* operation in OCL allows you to specify a Boolean expression which must hold for at least one object in a collection:

```
collection->exists( v : Type | boolean-expression-with-v )
collection->exists( v | boolean-expression-with-v )
collection->exists( boolean-expression )
```

This *exists* operation results in a Boolean. The result is true if the *boolean-expression-with-v* is true for at least one element of *collection*. If the *boolean-expression-with-v* is false for all *v* in *collection*, then the complete expression evaluates to false. For example, in the context of a company:

```
context Company inv:
    self.employee->exists( forename = 'Jack' )
context Company inv:
    self.employee->exists( p | p.forename = 'Jack' )
context Company inv:
    self.employee->exists( p : Person | p.forename = 'Jack' )
```

These expressions evaluate to true if the *forename* feature of at least one employee is equal to 'Jack.'

7.6.5 Iterate Operation

The *iterate* operation is slightly more complicated, but is very generic. The operations *reject*, *select*, *forall*, *exists*, *collect*, can all be described in terms of *iterate*.

An accumulation builds one value by iterating over a collection.

```
collection->iterate( elem : Type; acc : Type = <expression> |
```

7 Object Constraint Language Specification

`expression-with-elim-and-acc)`

The variable *elem* is the iterator, as in the definition of *select*, *forAll*, etc. The variable *acc* is the accumulator. The accumulator gets an initial value *<expression>*.

When the iterate is evaluated, *elem* iterates over the *collection* and the *expression-with-elim-and-acc* is evaluated for each *elem*. After each evaluation of *expression-with-elim-and-acc*, its value is assigned to *acc*. In this way, the value of *acc* is built up during the iteration of the collection. The collect operation described in terms of iterate will look like:

```
collection->collect(x : T | x.property)
-- is identical to:
collection->iterate(x : T; acc : T2 = Bag{} |
                  acc->including(x.property))
```

Or written in Java-like pseudocode the result of the iterate can be calculated as:

```
iterate(elem : T; acc : T2 = value)
{
    acc = value;
    for(Enumeration e = collection.elements() ; e.hasMoreElements();
    ){
        elem = e.nextElement();
        acc = <expression-with-elim-and-acc>
    }
}
```

Although the Java pseudo code uses a ‘next element’, the *iterate* operation is defined for each collection type and the order of the iteration through the elements in the collection is not defined for Set and Bag. For a Sequence the order is the order of the elements in the sequence.

7.7 The Standard OCL Package

Each UML model that uses OCL constraints contains a predefined standard package called “UML_OCL”. This package is used by default in all other packages in the model to evaluate OCL expressions. This package contains all predefined OCL types and their features.

To extend the predefined OCL types, a modeler should define a separate package. The standard OCL package can be imported, and each OCL type can be extended with new features.

To specify that a package used the predefined OCL types from a user defined package instead of the standard package, the using package must define a Dependency with stereotype <<OCL_Types>> to the package which defines the extended OCL types.

A constraint on the user defined OCL package is that as a minimum all predefined OCL types with all of their features must be defined. The user defined package must be a proper extension to the standard OCL package.

7.8 Predefined OCL Types

This section contains all standard types defined within OCL, including all the properties defined on those types. Its signature and a description of its semantics define each property. Within the description, the reserved word 'result' is used to refer to the value that results from evaluating the property. In several places, post conditions are used to describe properties of the result. When there is more than one postcondition, all postconditions must be true.

7.8.1 Basic Types

The basic types used are Integer, Real, String, and Boolean. They are supplemented with OclExpression, OclType, and OclAny.

OclType

All types defined in a UML model, or pre-defined within OCL, have a type. This type is an instance of the OCL type called OclType. Access to this type allows the modeler limited access to the meta-level of the model. This can be useful for advanced modelers.

Properties of OclType, where the instance of OclType is called *type*.

`type.name : String`

The name of *type*.

`type.attributes : Set(String)`

The set of names of the attributes of *type*, as they are defined in the model.

`type.associationEnds : Set(String)`

The set of names of the navigable associationEnds of *type*, as they are defined in the model.

`type.operations : Set(String)`

The set of names of the operations of *type*, as they are defined in the model.

`type.supertypes : Set(OclType)`

The set of all direct supertypes of *type*.
post: `type.allSupertypes->includesAll(result)`

7 Object Constraint Language Specification

`type.allSupertypes : Set(OclType)`

The transitive closure of the set of all supertypes of *type*.

`type.allInstances : Set(type)`

The set of all instances of *type* and all its subtypes in existence at the snapshot at the time that the expression is evaluated.

OclAny

Within the OCL context, the type *OclAny* is the supertype of all types in the model and the basic predefined OCL type. The predefined OCL Collection types are not subtypes of *OclAny*. Properties of *OclAny* are available on each object in all OCL expressions.

All classes in a UML model inherit all properties defined on *OclAny*. To avoid name conflicts between properties in the model and the properties inherited from *OclAny*, all names on the properties of *OclAny* start with 'ocl.' Although theoretically there may still be name conflicts, they can be avoided. One can also use the `oclAsType()` operation to explicitly refer to the *OclAny* properties.

Properties of *OclAny*, where the instance of *OclAny* is called *object*.

`object = (object2 : OclAny) : Boolean`

True if *object* is the same object as *object2*.

`object <> (object2 : OclAny) : Boolean`

True if *object* is a different object from *object2*.
post: result = not (object = object2)

`object.oclIsKindOf(type : OclType) : Boolean`

True if *type* is one of the types of *object*, or one of the supertypes (transitive) of the types of *object*.

`object.oclIsTypeOf(type : OclType) : Boolean`

True if *type* is equal to one of the types of *object*.

7.8 Predefined OCL Types

object.oclAsType(type : OclType) : type

Results in *object*, but of known type *type*.
Results in Undefined if the actual type of *object* is not type or one of its subtypes.
pre : object.oclIsKindOf(type)
post: result = object
post: result.oclIsKindOf(type)

object.oclInState(state : OclState) : Boolean

Results in true if *object* is in the state *state*, otherwise results in false. The argument is a name of a state in the state machine corresponding with the class of *object*.

object.oclIsNew : Boolean

Can only be used in a postcondition.
Evaluates to true if the *object* is created during performing the operation.
I.e. it didn't exist at precondition time.

OclState

The type OclState is used as a parameter for the operation *oclInState*. There are no properties defined on OclState. One can only specify an OclState by using the name of the state, as it appears in a statemachine. These names can be fully qualified by the nested states and statemachine that contain them.

OclExpression

Each OCL expression itself is an object in the context of OCL. The type of the expression is OclExpression. This type and its properties are used to define the semantics of properties that take an expression as one of their parameters: select, collect, forAll, etc.

An OclExpression includes the optional iterator variable and type and the optional accumulator variable and type.

Properties of OclExpression, where the instance of OclExpression is called *expression*.

expression.evaluationType : OclType

The type of the object that results from evaluating *expression*.

7 Object Constraint Language Specification

Real

The OCL type *Real* represents the mathematical concept of real. Note that *Integer* is a subclass of *Real*, so for each parameter of type *Real*, you can use an integer as the actual parameter.

Properties of *Real*, where the instance of *Real* is called *r*.

$r = (r2 : \text{Real}) : \text{Boolean}$

True if *r* is equal to *r2*.

$r \neq (r2 : \text{Real}) : \text{Boolean}$

True if *r* is not equal to *r2*.

post: result = not ($r = r2$)

$r + (r2 : \text{Real}) : \text{Real}$

The value of the addition of *r* and *r2*.

$r - (r2 : \text{Real}) : \text{Real}$

The value of the subtraction of *r2* from *r*.

$r * (r2 : \text{Real}) : \text{Real}$

The value of the multiplication of *r* and *r2*.

$r / (r2 : \text{Real}) : \text{Real}$

The value of *r* divided by *r2*.

r.abs : *Real*

The absolute value of *r*.

post: if $r < 0$ then result = - *r* else result = *r* endif

7.8 Predefined OCL Types

`r.floor` : Integer

The largest integer which is less than or equal to r .
post: $(\text{result} \leq r)$ and $(\text{result} + 1 > r)$

`r.round` : Integer

The integer which is closest to r . When there are two such integers, the largest one.
post: $((r - \text{result}) < r.\text{abs} < 0.5)$ or $((r - \text{result}).\text{abs} = 0.5$ and $(\text{result} > r)$

`r.max($r2$: Real)` : Real

The maximum of r and $r2$.
post: if $r \geq r2$ then result = r else result = $r2$ endif

`r.min($r2$: Real)` : Real

The minimum of r and $r2$.
post: if $r \leq r2$ then result = r else result = $r2$ endif

`r < ($r2$: Real)` : Boolean

True if $r1$ is less than $r2$.

`r > ($r2$: Real)` : Boolean

True if $r1$ is greater than $r2$.
post: result = not $(r \leq r2)$

`r <= ($r2$: Real)` : Boolean

True if $r1$ is less than or equal to $r2$.
post: result = $(r = r2)$ or $(r < r2)$

7 Object Constraint Language Specification

$r \geq (r2 : \text{Real}) : \text{Boolean}$

True if $r1$ is greater than or equal to $r2$.
post: result = $(r = r2)$ or $(r > r2)$

Integer

The OCL type Integer represents the mathematical concept of integer.

Properties of Integer, where the instance of Integer is called i .

$i = (i2 : \text{Integer}) : \text{Boolean}$

True if i is equal to $i2$.

$i + (i2 : \text{Integer}) : \text{Integer}$

The value of the addition of i and $i2$.

$i - (i2 : \text{Integer}) : \text{Integer}$

The value of the subtraction of $i2$ from i .

$i * (i2 : \text{Integer}) : \text{Integer}$

The value of the multiplication of i and $i2$.

$i / (i2 : \text{Integer}) : \text{Real}$

The value of i divided by $i2$.

$i.\text{abs} : \text{Integer}$

The absolute value of i .
post: if $i < 0$ then result = $- i$ else result = i endif

7.8 Predefined OCL Types

`i.div(i2 : Integer) : Integer`

The number of times that *i2* fits completely within *i*.

pre : $i2 \neq 0$

post: if $i / i2 \geq 0$ then result = $(i / i2).floor$ else result = $-((-i/i2).floor)$ endif

`i.mod(i2 : Integer) : Integer`

The result is *i* modulo *i2*.

post: result = $i - (i.div(i2) * i2)$

`i.max(i2 : Integer) : Integer`

The maximum of *i* and *i2*.

post: if $i \geq i2$ then result = *i* else result = *i2* endif

`i.min(i2 : Integer) : Integer`

The minimum of *i* and *i2*.

post: if $i \leq i2$ then result = *i* else result = *i2* endif

String

The OCL type `String` represents ASCII strings.

Properties of `String`, where the instance of `String` is called *string*.

`string = (string2 : String) : Boolean`

True if *string* and *string2* contain the same characters, in the same order.

`string.size : Integer`

The number of characters in *string*.

`string.concat(string2 : String) : String`

The concatenation of *string* and *string2*.

post: result.size = string.size + string2.size

post: result.substring(1, string.size) = string

post: result.substring(string.size + 1, result.size) = string2

7 Object Constraint Language Specification

string.toUpper : String

The value of *string* with all lowercase characters converted to uppercase characters.
post: result.size = string.size

string.toLowerCase : String

The value of *string* with all uppercase characters converted to lowercase characters.
post: result.size = string.size

string.substring(lower : Integer, upper : Integer) : String

The sub-string of *string* starting at character number *lower*, up to and including character number *upper*.

Boolean

The OCL type Boolean represents the common true/false values.

Features of Boolean, the instance of Boolean is called *b*.

b = (b2 : Boolean) : Boolean

Equal if *b* is the same as *b2*.

b or (b2 : Boolean) : Boolean

True if either *b* or *b2* is true.

b xor (b2 : Boolean) : Boolean

True if either *b* or *b2* is true, but not both.
post: (b or b2) and not (b = b2)

b and (b2 : Boolean) : Boolean

True if both *b1* and *b2* are true.

not b : Boolean

True if *b* is false.
post: if b then result = false else result = true endif

`b implies (b2 : Boolean) : Boolean`
True if *b* is false, or if *b* is true and *b2* is true.
post: (not b) or (b and b2)

`if b then (expression1 : OclExpression)`
`else (expression2 : OclExpression) endif : expression1.evaluationType`
If *b* is true, the result is the value of evaluating *expression1*; otherwise, result is the value of evaluating *expression2*.

Enumeration

The OCL type Enumeration represents the enumerations defined in an UML model.

Features of Enumeration, the instance of Enumeration is called *enumeration*.

`enumeration = (enumeration2 : Boolean) : Boolean`
Equal if *enumeration* is the same as *enumeration2*.

`enumeration <> (enumeration2 : Boolean) : Boolean`
Equal if *enumeration* is not the same as *enumeration2*.
post: result = not (enumeration = enumeration2)

7.8.2 Collection-Related Types

The following sections define the properties on collections (i.e., these properties are available on Set, Bag, and Sequence). As defined in this section, each collection type is actually a template with one parameter. 'T' denotes the parameter. A real collection type is created by substituting a type for the T. So Set (Integer) and Bag (Person) are collection types.

Collection

Collection is the abstract supertype of all collection types in OCL. Each occurrence of an object in a collection is called an element. If an object occurs twice in a collection, there are two elements. This section defines the properties on Collections that have identical semantics for all collection subtypes. Some properties may be defined with the subtype as well, which means that there is an additional postcondition or a more specialized return value.

The definition of several common properties is different for each subtype. These properties are not mentioned in this section.

7 Object Constraint Language Specification

Properties of Collection, where the instance of Collection is called *collection*.

collection->size : Integer

The number of elements in the collection *collection*.

post: result = collection->iterate(elem; acc : Integer = 0 | acc + 1)

collection->includes(object : OclAny) : Boolean

True if *object* is an element of *collection*, false otherwise.

post: result = (collection->count(object) > 0)

collection->excludes(object : OclAny) : Boolean

True if *object* is not an element of *collection*, false otherwise.

post: result = (collection->count(object) = 0)

collection->count(object : OclAny) : Integer

The number of times that *object* occurs in the collection *collection*.

post: result = collection->iterate(elem; acc : Integer = 0 |
if elem = object then acc + 1 else acc endif)

collection->includesAll(c2 : Collection(T)) : Boolean

Does *collection* contain all the elements of *c2* ?

post: result = c2->forAll(elem | collection->includes(elem))

collection->excludesAll(c2 : Collection(T)) : Boolean

Does *collection* contain none of the elements of *c2* ?

post: result = c2->forAll(elem | collection->excludes(elem))

collection->isEmpty : Boolean

Is *collection* the empty collection?

post: result = (collection->size = 0)

7.8 Predefined OCL Types

collection->notEmpty : Boolean

Is *collection* not the empty collection?
post: result = (collection->size <> 0)

collection->sum : T

The addition of all elements in *collection*. Elements must be of a type supporting the + operation. The + operation must take one parameter of type T and be both associative: $(a+b)+c = a+(b+c)$, and commutative: $a+b = b+a$. Integer and Real fulfill this condition.

post: result = collection->iterate(elem; acc : T = 0 |
acc + elem)

collection->exists(expr : OclExpression) : Boolean

Results in true if *expr* evaluates to true for at least one element in *collection*.

post: result = collection->iterate(elem; acc : Boolean = false |
acc or expr)

collection->forAll(expr : OclExpression) : Boolean

Results in true if *expr* evaluates to true for each element in *collection*; otherwise, result is false.

post: result = collection->iterate(elem; acc : Boolean = true |
acc and expr)

collection->isUnique(expr : OclExpression) : Boolean

Results in true if *expr* evaluates to a different value for each element in *collection*; otherwise, result is false.

post: result = collection->collect(expr)->forAll(e1, e2 | e1 <> e2)

7 Object Constraint Language Specification

collection->sortedBy(expr : OclExpression) : Boolean

Results in the Sequence containing all elements of *collection*. The element for which *expr* has the lowest value comes first, and so on. The type of the *expr* expression must have the < operation defined. The < operation must be transitive i.e. if $a < b$ and $b < c$ then $a < c$.

post:

collection->iterate(expr : OclExpression) : expr.evaluationType

Iterates over the collection. See “Iterate Operation” on page 7-25 for a complete description. This is the basic collection operation with which the other collection operations can be described.

Set

The Set is the mathematical set. It contains elements without duplicates. Features of Set, the instance of Set is called *set*.

set->union(set2 : Set(T)) : Set(T)

The union of *set* and *set2*.

post: result->forAll(elem | set->includes(elem) or set2->includes(elem))

post: set->forAll(elem | result->includes(elem))

post: set2->forAll(elem | result->includes(elem))

set->union(bag : Bag(T)) : Bag(T)

The union of *set* and *bag*.

post: result->forAll(elem |

result->count(elem) = set->count(elem) + bag->count(elem))

post: set->forAll(elem | result->includes(elem))

post: bag->forAll(elem | result->includes(elem))

set = (set2 : Set(T)) : Boolean

Evaluates to true if *set* and *set2* contain the same elements.

post: result = (set->forAll(elem | set2->includes(elem)) and

set2->forAll(elem | set->includes(elem)))

7.8 Predefined OCL Types

`set->intersection(set2 : Set(T)) : Set(T)`

The intersection of *set* and *set2* (i.e, the set of all elements that are in both *set* and *set2*).

post: result->forAll(elem | set->includes(elem) and set2->includes(elem))

post: set->forAll(elem | set2->includes(elem) = result->includes(elem))

post: set2->forAll(elem | set->includes(elem) = result->includes(elem))

`set->intersection(bag : Bag(T)) : Set(T)`

The intersection of *set* and *bag*.

post: result = set->intersection(bag->asSet)

`set - (set2 : Set(T)) : Set(T)`

The elements of *set*, which are not in *set2*.

post: result->forAll(elem | set->includes(elem) and set2->excludes(elem))

post: set->forAll(elem | result->includes(elem) = set2->excludes(elem))

`set->including(object : T) : Set(T)`

The set containing all elements of *set* plus *object*.

post: result->forAll(elem | set->includes(elem) or (elem = object))

post: set->forAll(elem | result->includes(elem))

post: result->includes(object)

`set->excluding(object : T) : Set(T)`

The set containing all elements of *set* without *object*.

post: result->forAll(elem | set->includes(elem) and (elem <> object))

post: set->forAll(elem | result->includes(elem) = (object <> elem))

post: result->excludes(object)

7 Object Constraint Language Specification

set->symmetricDifference(set2 : Set(T)) : Set(T)

The sets containing all the elements that are in *set* or *set2*, but not in both.

post: result->forAll(elem | set->includes(elem) xor set2->includes(elem))
post: set->forAll(elem | result->includes(elem) = set2->excludes(elem))
post: set2->forAll(elem | result->includes(elem) = set->excludes(elem))

set->select(expr : OclExpression) : Set(T)

The subset of *set* for which *expr* is true.

post: result = set->iterate(elem; acc : Set(T) = Set{ } |
if expr then acc->including(elem) else acc endif)

set->reject(expr : OclExpression) : Set(T)

The subset of *set* for which *expr* is false.

post: result = set->select(not expr)

set->collect(expr : OclExpression) : Bag(expr.evaluationType)

The Bag of elements which results from applying *expr* to every member of *set*.

post: result = set->iterate(elem; acc : Bag(expr.evaluationType) = Bag{ } |
acc->including(expr))

set->count(object : T) : Integer

The number of occurrences of *object* in *set*.

post: result <= 1

set->asSequence : Sequence(T)

A Sequence that contains all the elements from *set*, in undefined order.

post: result->forAll(elem | set->includes(elem))
post: set->forAll(elem | result->count(elem) = 1)

`set->asBag : Bag(T)`

The Bag that contains all the elements from *set*.

post: `result->forAll(elem | set->includes(elem))`

post: `set->forAll(elem | result->count(elem) = 1)`

Bag

A bag is a collection with duplicates allowed. That is, one object can be an element of a bag many times. There is no ordering defined on the elements in a bag.

Properties of Bag, where the instance of Bag is called *bag*.

`bag = (bag2 : Bag(T)) : Boolean`

True if *bag* and *bag2* contain the same elements, the same number of times.

post: `result = (bag->forAll(elem | bag->count(elem) = bag2->count(elem)) and
bag2->forAll(elem | bag2->count(elem) = bag->count(elem)))`

`bag->union(bag2 : Bag(T)) : Bag(T)`

The union of *bag* and *bag2*.

post: `result->forAll(elem |
result->count(elem) = bag->count(elem) + bag2->count(elem))`

post: `bag->forAll(elem |
result->count(elem) = bag->count(elem) + bag2->count(elem))`

post: `bag2->forAll(elem |
result->count(elem) = bag->count(elem) + bag2->count(elem))`

`bag->union(set : Set(T)) : Bag(T)`

The union of *bag* and *set*.

post: `result->forAll(elem |
result->count(elem) = bag->count(elem) + set->count(elem))`

post: `bag->forAll(elem |
result->count(elem) = bag->count(elem) + set->count(elem))`

post: `set->forAll(elem |
result->count(elem) = bag->count(elem) + set->count(elem))`

7 Object Constraint Language Specification

bag->intersection(bag2 : Bag(T)) : Bag(T)

The intersection of *bag* and *bag2*.

```
post: result->forAll(elem |
    result->count(elem) = bag->count(elem).min(bag2->count(elem)) )
post: bag->forAll(elem |
    result->count(elem) = bag->count(elem).min(bag2->count(elem)) )
post: bag2->forAll(elem |
    result->count(elem) = bag->count(elem).min(bag2->count(elem)) )
```

bag->intersection(set : Set(T)) : Set(T)

The intersection of *bag* and *set*.

```
post: result->forAll(elem |
    result->count(elem) = bag->count(elem).min(set->count(elem)) )
post: bag->forAll(elem |
    result->count(elem) = bag->count(elem).min(set->count(elem)) )
post: set->forAll(elem |
    result->count(elem) = bag->count(elem).min(set->count(elem)) )
```

bag->including(object : T) : Bag(T)

The bag containing all elements of *bag* plus *object*.

```
post: result->forAll(elem |
    if elem = object then
        result->count(elem) = bag->count(elem) + 1
    else
        result->count(elem) = bag->count(elem)
    endif)
post: bag->forAll(elem |
    if elem = object then
        result->count(elem) = bag->count(elem) + 1
    else
        result->count(elem) = bag->count(elem)
    endif)
```

7.8 Predefined OCL Types

`bag->excluding(object : T) : Bag(T)`

The bag containing all elements of *bag* apart from all occurrences of *object*.

```
post: result->forAll(elem |
if elem = object then
    result->count(elem) = 0
else
    result->count(elem) = bag->count(elem)
endif)
post: bag->forAll(elem |
if elem = object then
    result->count(elem) = 0
else
    result->count(elem) = bag->count(elem)
endif)
```

`bag->select(expr : OclExpression) : Bag(T)`

The sub-bag of *bag* for which *expr* is true.

```
post: result = bag->iterate(elem; acc : Bag(T) = Bag{ } |
if expr then acc->including(elem) else acc endif)
```

`bag->reject(expr : OclExpression) : Bag(T)`

The sub-bag of *bag* for which *expr* is false.

```
post: result = bag->select(not expr)
```

`bag->collect(expr: OclExpression) : Bag(expr.evaluationType)`

The Bag of elements which results from applying *expr* to every member of *bag*.

```
post: result = bag->iterate(elem; acc : Bag(expr.evaluationType) = Bag{ } |
acc->including(expr )
```

`bag->count(object : T) : Integer`

The number of occurrences of *object* in *bag*.

7 Object Constraint Language Specification

bag->asSequence : Sequence(T)

A Sequence that contains all the elements from *bag*, in undefined order.

post: result->forAll(elem | bag->count(elem) = result->count(elem))

post: bag->forAll(elem | bag->count(elem) = result->count(elem))

bag->asSet : Set(T)

The Set containing all the elements from *bag*, with duplicates removed.

post: result->forAll(elem | bag->includes(elem))

post: bag->forAll(elem | result->includes(elem))

Sequence

A sequence is a collection where the elements are ordered. An element may be part of a sequence more than once.

Properties of Sequence(T), where the instance of Sequence is called *sequence*.

sequence->count(object : T) : Integer

The number of occurrences of *object* in *sequence*.

sequence = (sequence2 : Sequence(T)) : Boolean

True if *sequence* contains the same elements as *sequence2* in the same order.

post: result = Sequence{ 1..sequence->size }->forAll(index : Integer |
sequence->at(index) = sequence2->at(index))

and

sequence->size = sequence2->size

sequence->union (sequence2 : Sequence(T)) : Sequence(T)

The sequence consisting of all elements in *sequence*, followed by all elements in *sequence2*.

post: result->size = sequence->size + sequence2->size

post: Sequence{ 1..sequence->size }->forAll(index : Integer |
sequence->at(index) = result->at(index))

post: Sequence{ 1..sequence2->size }->forAll(index : Integer |
sequence2->at(index) =

result->at(index + sequence->size)))

7.8 Predefined OCL Types

sequence->append (object: T) : Sequence(T)

The sequence of elements, consisting of all elements of *sequence*, followed by *object*.

post: result->size = sequence->size + 1

post: result->at(result->size) = object

post: Sequence{1..sequence->size}->forall(index : Integer |
result->at(index) = sequence->at(index))

sequence->prepend(object : T) : Sequence(T)

The sequence consisting of *object*, followed by all elements in *sequence*.

post: result->size = sequence->size + 1

post: result->at(1) = object

post: Sequence{1..sequence->size}->forall(index : Integer |
sequence->at(index) = result->at(index + 1))

sequence->subSequence(lower : Integer, upper : Integer) : Sequence(T)

The sub-sequence of *sequence* starting at number *lower*, up to and including element number *upper*.

pre : 1 <= lower

pre : lower <= upper

pre : upper <= sequence->size

post: result->size = upper - lower + 1

post: Sequence{lower..upper}->forall(index |
result->at(index - lower + 1) =
sequence->at(index))

endif

sequence->at(i : Integer) : T

The *i*-th element of *sequence*.

pre : i >= 1 and i <= sequence->size

sequence->first : T

The first element in *sequence*.

post: result = sequence->at(1)

7 Object Constraint Language Specification

sequence->last : T

The last element in *sequence*.

post: result = sequence->at(sequence->size)

sequence->including(object : T) : Sequence(T)

The sequence containing all elements of *sequence* plus *object* added as the last element.

post: result = sequence.append(object)

sequence->excluding(object : T) : Sequence(T)

The sequence containing all elements of *sequence* apart from all occurrences of *object*. The order of the remaining elements is not changed.

post:result->includes(object) = false

post: result->size = sequence->size - sequence->count(object)

post: result = sequence->iterate(elem; acc : Sequence(T)

= Sequence{ } |

if elem = object then acc else acc->append(elem) endif)

sequence->select(expression : OclExpression) : Sequence(T)

The subsequence of *sequence* for which *expression* is true.

post: result = sequence->iterate(elem; acc : Sequence(T) = Sequence{ } |

if expr then acc->including(elem) else acc endif)

sequence->reject(expression : OclExpression) : Sequence(T)

The subsequence of *sequence* for which *expression* is false.

post: result = sequence->select(not expr)

sequence->collect(expression : OclExpression) : Sequence(expression.evaluationType)

The Sequence of elements which results from applying *expression* to every member of *sequence*.

```
sequence->iterate(expr : OclExpression) : expr.evaluationType
```

Iterates over the sequence. Iteration will be done from element at position 1 up until the element at the last position following the order of the sequence.

```
sequence->asBag() : Bag(T)
```

The Bag containing all the elements from *sequence*, including duplicates.

```
post: result->forAll(elem | sequence->count(elem) = result->count(elem) )
```

```
post: sequence->forAll(elem | sequence->count(elem) = result->count(elem) )
```

```
sequence->asSet() : Set(T)
```

The Set containing all the elements from *sequence*, with duplicated removed.

```
post: result->forAll(elem | sequence->includes(elem))
```

```
post: sequence->forAll(elem | result->includes(elem))
```

7.9 Grammar

This section describes the grammar for OCL expressions. An executable LL(1) version of this grammar is available on the OCL web site. (See <http://www.software.ibm.com/ad/ocl>).

The grammar description uses the EBNF syntax, where “[|]” means a choice, “[?]” optionality, and “[*]” means zero or more times, “[+]” means one or more times. In the description of the *name*, *typeName*, and *string*, the syntax for lexical tokens from the JavaCC parser generator is used. (See <http://www.suntest.com/JavaCC>.)

```
constraint                := contextDeclaration
                           (stereotype name? ":" expression)+
contextDeclaration        := "context"
                           (classifierContext | operationContext)
classifierContext         := (<name> ":")? <typeName>
operationContext          := <typeName> ":" <name>
                           "(" formalParameterList? ")"
                           ( ":" <typeName> )?
formalParameterList      := formalParameter (";" formalParameter)*
formalParameter           := <name> ":" <typeName>
stereotype                := "inv" | "pre" | "post"
expression                := letExpression* logicalExpression
ifExpression              := "if" expression
```

7 Object Constraint Language Specification

```

"then" expression
"else" expression
"endif"
logicalExpression      := relationalExpression
                        ( logicalOperator
                          relationalExpression )*
relationalExpression  := additiveExpression
                        ( relationalOperator
                          additiveExpression )?
additiveExpression    := multiplicativeExpression
                        ( addOperator
                          multiplicativeExpression )*
multiplicativeExpression := unaryExpression
                        ( multiplyOperator unaryExpression )*
unaryExpression       := ( unaryOperator postfixExpression )
                        | postfixExpression
postfixExpression     := primaryExpression ( "." | "->"
                                             featureCall )*
primaryExpression     := literalCollection
                        | literal
                        | pathName timeExpression? qualifier?
                        featureCallParameters?
                        | "(" expression ")"
                        | ifExpression
featureCallParameters := "(" ( declarator )?
                        ( actualParameterList )? ")"
letExpression         := "let" <name>
                        ( ":" pathTypeName )?
                        "=" expression "in"
literal               := <STRING> | <number> | "#" <name>
enumerationType      := "enum" "{" "#" <name> ( "," "#" <name>
                                             )* "}"
simpleTypeSpecifier    := pathTypeName
                        | enumerationType
literalCollection     := collectionKind "{"
                        expressionListOrRange? "}"
expressionListOrRange := expression
                        ( ( "," expression )+
                          | ( ".." expression )
                          )?
featureCall           := pathName timeExpression? qualifiers?
                        featureCallParameters?
```

```

qualifiers           := "[" actualParameterList "]"
declarator           := <name> ( "," <name> )*
                    ( ":" simpleTypeSpecifier )? "|"
pathTypeName        := <typeName> ( ":" <typeName> )*
pathName            := ( <typeName> | <name> )
                    ( ":" ( <typeName> | <name> ) )*

timeExpression      := "@" <name>
actualParameterList := expression ( "," expression )*
logicalOperator     := "and" | "or" | "xor" | "implies"
collectionKind      := "Set" | "Bag" | "Sequence" |
                    "Collection"

relationalOperator  := "=" | ">" | "<" | ">=" | "<=" | "<>"
addOperator         := "+" | "-"
multiplyOperator    := "*" | "/"
unaryOperator       := "-" | "not"
typeName            := ( ["a"- "z"] | ["A"- "Z"] | "_" )
                    ( ["a"- "z"] | ["0"- "9"] |
                      ["A"- "Z"] | "_" )*
name                := ( ["a"- "z"] | ["A"- "Z"] | "_" )
                    ( ["a"- "z"] | ["0"- "9"] |
                      ["A"- "Z"] | "_" )*

number              := ["0"- "9"] ( ["0"- "9"] )*
string              := "'" ( (~["'", "\\", "\n", "\r"]
                    | ("\\")
                    ( ["n", "t", "b", "r", "f", "\\", "'", "\"]
                    | ["0"- "7"] ( ["0"- "7"] )?
                    | ["0"- "3"] ["0"- "7"] ["0"- "7"]
                    )
                    )
                    )
                    )*
                    "'"

```

7 Object Constraint Language Specification

UML Standard Elements

A

This appendix contains a list of the predefined standard elements for UML. The standard elements are stereotypes, constraints and tagged values. The names used for UML predefined standard elements are considered reserved words; modelers should not use overload these names with different definitions. Each standard element is described in the chapter containing its base element.

| Standard Element Name | Applies to Base Element | Kind | Page |
|------------------------------|--------------------------------|-------------|-------------|
| «access» | Permission | Stereotype | 2-42 |
| association | Association | Constraint | 2-91 |
| «association» | AssociationEnd | Stereotype | 2-23 |
| «become» | Flow | Stereotype | 2-34 |
| «call» | Usage | Stereotype | 2-43 |
| complete | Generalization | Constraint | 2-36 |
| «copy» | Flow | Stereotype | 2-34 |
| «create» | BehavioralFeature | Stereotype | 2-26 |
| «create» | CallEvent | Stereotype | 2-132 |
| «create» | Usage | Stereotype | 2-44 |
| «derive» | Abstraction | Stereotype | 2-19 |
| derived | ModelElement | Tag | 2-38 |
| «destroy» | BehavioralFeature | Stereotype | 2-26 |
| «destroy» | CallEvent | Stereotype | 2-132 |
| destroyed | Association | Constraint | 2-90 |
| destroyed | Association | Constraint | 2-91 |
| disjoint | Generalization | Constraint | 2-36 |
| «document» | Component | Stereotype | 2-29 |
| documentation | Element | Tag | 2-31 |

A UML Standard Elements

| | | | |
|-----------------------|-----------------|------------|-------|
| «executable» | Component | Stereotype | 2-29 |
| «facade» | Package | Stereotype | 2-174 |
| «file» | Component | Stereotype | 2-29 |
| «framework» | Package | Stereotype | 2-174 |
| «friend» | Permission | Stereotype | 2-42 |
| global | Association | Constraint | 2-91 |
| «global» | AssociationEnd | Stereotype | 2-23 |
| «implementation» | Generalization | Stereotype | 2-36 |
| «implementationClass» | Class | Stereotype | 2-27 |
| implicit | Association | Stereotype | 2-20 |
| «import» | Permission | Stereotype | 2-42 |
| incomplete | Generalization | Constraint | 2-36 |
| «instantiate» | Usage | Stereotype | 2-44 |
| «invariant» | Constraint | Stereotype | 2-30 |
| «library» | Component | Stereotype | 2-29 |
| local | Association | Constraint | 2-91 |
| «local» | AssociationEnd | Stereotype | 2-23 |
| «metaclass» | Classifier | Stereotype | 2-28 |
| «metamodel» | Package | Stereotype | 2-173 |
| new | Association | Constraint | 2-90 |
| new | Association | Constraint | 2-91 |
| overlapping | Generalization | Constraint | 2-36 |
| parameter | Association | Constraint | 2-91 |
| «parameter» | AssociationEnd | Stereotype | 2-23 |
| persistence | Association | Tag | 2-20 |
| persistence | Attribute | Tag | 2-25 |
| persistence | Classifier | Tag | 2-28 |
| persistent | Association | Tag | 2-90 |
| «postcondition» | Constraint | Stereotype | 2-30 |
| «powertype» | Classifier | Stereotype | 2-28 |
| «precondition» | Constraint | Stereotype | 2-30 |
| «process» | Classifier | Stereotype | 2-28 |
| «realize» | Abstraction | Stereotype | 2-19 |
| «refine» | Abstraction | Stereotype | 2-19 |
| «requirement» | Comment | Stereotype | 2-29 |
| «responsibility» | Comment | Stereotype | 2-29 |
| self | Association | Constraint | 2-91 |
| «self» | AssociationEnd | Stereotype | 2-23 |
| semantics | Classifier | Tag | 2-28 |
| semantics | Operation | Tag | 2-40 |
| «send» | Usage | Stereotype | 2-44 |
| «signalflow» | ObjectFlowState | Stereotype | 2-163 |
| «stub» | Package | Stereotype | 2-174 |
| «systemModel» | Package | Stereotype | 2-173 |
| «table» | Component | Stereotype | 2-29 |
| «thread» | Classifier | Stereotype | 2-28 |
| «topLevel» | Package | Stereotype | 2-174 |
| «trace» | Abstraction | Stereotype | 2-19 |
| transient | Association | Constraint | 2-90 |
| transient | Association | Constraint | 2-91 |
| «type» | Class | Stereotype | 2-27 |

A UML Standard Elements

| | | | |
|-----------|-------------|------------|------|
| «utility» | Classifier | Stereotype | 2-28 |
| xor | Association | Constraint | 2-20 |

This glossary defines the terms that are used to describe the Unified Modeling Language (UML) and the Meta Object Facility (MOF). In addition to UML and MOF specific terminology, it includes related terms from OMG standards and object-oriented analysis and design methods, as well as the domain of object repositories and meta data managers. Glossary entries are organized alphabetically and MOF specific entries are identified as '[MOF]'.

Notation Conventions

The entries in the glossary usually begin with a lowercase letter. An initial uppercase letter is used when a word is usually capitalized in standard practice. Acronyms are all capitalized, unless they traditionally appear in all lowercase.

When one or more words in a multi-word term is enclosed in brackets, it indicates that those words are optional when referring to the term. For example, *use case [class]* may be referred to as simply *use case*.

The following conventions are used in this glossary:

- **Contrast:** <term>
Refers to a term that has an opposed or substantively different meaning.
- **See:** <term>
Refers to a related term that has a similar, but not synonymous meaning.
- **Synonym:** <term>
Indicates that the term has the same meaning as another term, which is referenced.
- **Acronym:** <term>
Indicates that the term is an acronym. The reader is usually referred to the spelled-out term for the definition, unless the spelled-out term is rarely used.

Glossary Terms

| | |
|--------------------------|--|
| abstract class | A class that cannot be directly instantiated. Contrast: <i>concrete class</i> . |
| abstraction | The essential characteristics of an entity that distinguish it from all other kinds of entities. An abstraction defines a boundary relative to the perspective of the viewer. |
| action | The specification of an executable statement that forms an abstraction of a computational procedure. An action typically results in a change in the state of the system, and can be realized by sending a message to an object or modifying a link or a value of an attribute. |
| action sequence | An expression that resolves to a sequence of actions. |
| action state | A state that represents the execution of an atomic action, typically the invocation of an operation. |
| activation | The execution of an action. |
| active class | A class whose instances are active objects. See: <i>active object</i> . |
| active object | An object that owns a thread and can initiate control activity. An instance of active class. See: <i>active class</i> , <i>thread</i> . |
| activity graph | A special case of a state machine that is used to model processes involving one or more classifiers. Contrast: <i>statechart diagram</i> . |
| actor [class] | A coherent set of roles that users of use cases play when interacting with these use cases. An actor has one role for each use case with which it communicates. |
| actual parameter | Synonym: <i>argument</i> . |
| aggregate [class] | A class that represents the “whole” in an aggregation (whole-part) relationship. See: <i>aggregation</i> . |
| aggregation | A special form of association that specifies a whole-part relationship between the aggregate (whole) and a component part. See: <i>composition</i> . |

| | |
|--------------------------------|---|
| analysis | The part of the software development process whose primary purpose is to formulate a model of the problem domain. Analysis focuses what to do, design focuses on how to do it. Contrast: <i>design</i> . |
| analysis time | Refers to something that occurs during an analysis phase of the software development process. See: <i>design time</i> , <i>modeling time</i> . |
| architecture | The organizational structure and associated behavior of a system. An architecture can be recursively decomposed into parts that interact through interfaces, relationships that connect parts, and constraints for assembling parts. Parts that interact through interfaces include classes, components and subsystems. |
| argument | A binding for a parameter that resolves to a run-time instance. Synonym: <i>actual parameter</i> . Contrast: <i>parameter</i> . |
| artifact | A piece of information that is used or produced by a software development process. An artifact can be a model, a description, or software. Synonym: <i>product</i> . |
| association | The semantic relationship between two or more classifiers that specifies connections among their instances. |
| association class | A model element that has both association and class properties. An association class can be seen as an association that also has class properties, or as a class that also has association properties. |
| association end | The endpoint of an association, which connects the association to a classifier. |
| attribute | A feature within a classifier that describes a range of values that instances of the classifier may hold. |
| behavior | The observable effects of an operation or event, including its results. |
| behavioral feature | A dynamic feature of a model element, such as an operation or method. |
| behavioral model aspect | A model aspect that emphasizes the behavior of the instances in a system, including their methods, collaborations, and state histories. |

B OMG Modeling Glossary

| | |
|---------------------------|---|
| binary association | An association between two classes. A special case of an n-ary association. |
| binding | The creation of a model element from a template by supplying arguments for the parameters of the template. |
| boolean | An enumeration whose values are true and false. |
| boolean expression | An expression that evaluates to a boolean value. |
| cardinality | The number of elements in a set. Contrast: <i>multiplicity</i> . |
| child | In a generalization relationship, the specialization of another element, the parent. See: <i>subclass</i> , <i>subtype</i> . Contrast: <i>parent</i> . |
| call | An action state that invokes an operation on a classifier. |
| class | A description of a set of objects that share the same attributes, operations, methods, relationships, and semantics. A class may use a set of interfaces to specify collections of operations it provides to its environment. See: <i>interface</i> . |
| classifier | A mechanism that describes behavioral and structural features. Classifiers include interfaces, classes, datatypes, and components. |
| classification | The assignment of an object to a classifier. See <i>dynamic classification</i> , <i>multiple classification</i> and <i>static classification</i> . |
| class diagram | A diagram that shows a collection of declarative (static) model elements, such as classes, types, and their contents and relationships. |
| client | A classifier that requests a service from another classifier. Contrast: <i>supplier</i> . |
| collaboration | The specification of how an operation or classifier, such as a use case, is realized by a set of classifiers and associations playing specific roles used in a specific way. The collaboration defines an interaction. See: <i>interaction</i> . |

| | |
|------------------------------|--|
| collaboration diagram | A diagram that shows interactions organized around the structure of a model, using either classifiers and associations or instances and links. Unlike a sequence diagram, a collaboration diagram shows the relationships among the instances. Sequence diagrams and collaboration diagrams express similar information, but show it in different ways. See: <i>sequence diagram</i> . |
| comment | An annotation attached to an element or a collection of elements. A note has no semantics. Contrast: <i>constraint</i> . |
| compile time | Refers to something that occurs during the compilation of a software module. See: <i>modeling time, run time</i> . |
| component | A physical, replaceable part of a system that packages implementation and provides the realization of a set of interfaces. A component represents a physical piece of implementation of a system, including software code (source, binary or executable) or equivalents such as scripts or command files. |
| component diagram | A diagram that shows the organizations and dependencies among components. |
| composite [class] | A class that is related to one or more classes by a composition relationship. See: <i>composition</i> . |
| composite aggregation | Synonym: <i>composition</i> . |
| composite state | A state that consists of either concurrent (orthogonal) substates or sequential (disjoint) substates. See: <i>substate</i> . |
| composition | A form of aggregation association with strong ownership and coincident lifetime as part of the whole. Parts with non-fixed multiplicity may be created after the composite itself, but once created they live and die with it (i.e., they share lifetimes). Such parts can also be explicitly removed before the death of the composite. Composition may be recursive. Synonym: <i>composite aggregation</i> . |
| concrete class | A class that can be directly instantiated. Contrast: <i>abstract class</i> . |
| concurrency | The occurrence of two or more activities during the same time interval. Concurrency can be achieved by interleaving or simultaneously executing two or more threads. See: <i>thread</i> . |

| | |
|------------------------------|--|
| concurrent substate | A substate that can be held simultaneously with other substates contained in the same composite state. See: <i>composite state</i> . Contrast: <i>disjoint substate</i> . |
| constraint | A semantic condition or restriction. Certain constraints are predefined in the UML, others may be user defined. Constraints are one of three extensibility mechanisms in UML. See: <i>tagged value</i> , <i>stereotype</i> . |
| container | 1. An instance that exists to contain other instances, and that provides operations to access or iterate over its contents. (for example, arrays, lists, sets). 2. A component that exists to contain other components. |
| containment hierarchy | A namespace hierarchy consisting of model elements, and the containment relationships that exist between them. A containment hierarchy forms a graph. |
| context | A view of a set of related modeling elements for a particular purpose, such as specifying an operation. |
| datatype | A descriptor of a set of values that lack identity and whose operations do not have side effects. Datatypes include primitive pre-defined types and user-definable types. Pre-defined types include numbers, string and time. User-definable types include enumerations. |
| defining model [MOF] | The model on which a repository is based. Any number of repositories can have the same defining model. |
| delegation | The ability of an object to issue a message to another object in response to a message. Delegation can be used as an alternative to inheritance. Contrast: <i>inheritance</i> . |
| dependency | A relationship between two modeling elements, in which a change to one modeling element (the independent element) will affect the other modeling element (the dependent element). |
| deployment diagram | A diagram that shows the configuration of run-time processing nodes and the components, processes, and objects that live on them. Components represent run-time manifestations of code units. See: <i>component diagrams</i> . |

| | |
|-------------------------------|--|
| derived element | A model element that can be computed from another element, but that is shown for clarity or that is included for design purposes even though it adds no semantic information. |
| design | The part of the software development process whose primary purpose is to decide how the system will be implemented. During design strategic and tactical decisions are made to meet the required functional and quality requirements of a system. |
| design time | Refers to something that occurs during a design phase of the software development process. See: <i>modeling time</i> . Contrast: <i>analysis time</i> . |
| development process | A set of partially ordered steps performed for a given purpose during software development, such as constructing models or implementing models. |
| diagram | A graphical presentation of a collection of model elements, most often rendered as a connected graph of arcs (relationships) and vertices (other model elements). UML supports the following diagrams: class diagram, object diagram, use case diagram, sequence diagram, collaboration diagram, state diagram, activity diagram, component diagram, and deployment diagram. |
| disjoint substate | A substate that cannot be held simultaneously with other substates contained in the same composite state. See: composite state. Contrast: <i>concurrent substate</i> . |
| distribution unit | A set of objects or components that are allocated to a process or a processor as a group. A distribution unit can be represented by a run-time composite or an aggregate. |
| domain | An area of knowledge or activity characterized by a set of concepts and terminology understood by practitioners in that area. |
| dynamic classification | A semantic variation of generalization in which an object may change its classifier. Contrast: <i>static classification</i> . |
| element | An atomic constituent of a model. |
| entry action | An action executed upon entering a state in a state machine regardless of the transition taken to reach that state. |

B OMG Modeling Glossary

| | |
|-------------------------|--|
| enumeration | A list of named values used as the range of a particular attribute type. For example, <code>RGBColor = { red, green, blue }</code> . Boolean is a predefined enumeration with values from the set {false, true}. |
| event | The specification of a significant occurrence that has a location in time and space. In the context of state diagrams, an event is an occurrence that can trigger a transition. |
| exit action | An action executed upon exiting a state in a state machine regardless of the transition taken to exit that state. |
| export | In the context of packages, to make an element visible outside its enclosing namespace. See: <i>visibility</i> . Contrast: <i>export</i> [OMA], <i>import</i> . |
| expression | A string that evaluates to a value of a particular type. For example, the expression “(7 + 5 * 3)” evaluates to a value of type number. |
| extend | A relationship from an extension use case to a base use case, specifying how the behavior defined for the extension use case augments (subject to conditions specified in the extension) the behavior defined for the base use case. The behavior is inserted at the location defined by the extension point in the base use case. The base use case does not depend on performing the behavior of the extension use case. See <i>extension point</i> , <i>include</i> . |
| facade | A stereotyped package containing only references to model elements owned by another package. It is used to provide a ‘public view’ of some of the contents of a package. |
| feature | A property, like operation or attribute, which is encapsulated within a classifier, such as an interface, a class, or a datatype. |
| final state | A special kind of state signifying that the enclosing composite state or the entire state machine is completed. |
| fire | To execute a state transition. See: <i>transition</i> . |
| focus of control | A symbol on a sequence diagram that shows the period of time during which an object is performing an action, either directly or through a subordinate procedure. |
| formal parameter | Synonym: <i>parameter</i> . |

| | |
|-----------------------------------|---|
| framework | <p>1. A stereotyped package consisting mainly of patterns. See: <i>pattern</i>.</p> <p>2. An architectural pattern that provides an extensible template for applications within a specific domain.</p> |
| generalizable element | <p>A model element that may participate in a generalization relationship. See: <i>generalization</i>.</p> |
| generalization | <p>A taxonomic relationship between a more general element and a more specific element. The more specific element is fully consistent with the more general element and contains additional information. An instance of the more specific element may be used where the more general element is allowed. See: <i>inheritance</i>.</p> |
| guard condition | <p>A condition that must be satisfied in order to enable an associated transition to fire.</p> |
| implementation | <p>A definition of how something is constructed or computed. For example, a class is an implementation of a type, a method is an implementation of an operation.</p> |
| implementation inheritance | <p>The inheritance of the implementation of a more specific element. Includes inheritance of the interface. Contrast: <i>interface inheritance</i>.</p> |
| import | <p>In the context of packages, a dependency that shows the packages whose classes may be referenced within a given package (including packages recursively embedded within it). Contrast: <i>export</i>.</p> |
| include | <p>A relationship from a base use case to an inclusion use case, specifying how the behavior for the base use case contains the behavior of the inclusion use case. The behavior is included at the location which is defined in the base use case. The base use case depends on performing the behavior of the inclusion use case, but not on its structure (i.e., attributes or operations). See <i>extend</i>.</p> |
| inheritance | <p>The mechanism by which more specific elements incorporate structure and behavior of more general elements related by behavior. See <i>generalization</i>.</p> |
| instance | <p>An entity to which a set of operations can be applied and which has a state that stores the effects of the operations. See: <i>object</i>.</p> |

B *OMG Modeling Glossary*

| | |
|------------------------------|--|
| interaction | A specification of how stimuli are sent between instances to perform a specific task. The interaction is defined in the context of a collaboration. See <i>collaboration</i> . |
| interaction diagram | A generic term that applies to several types of diagrams that emphasize object interactions. These include collaboration diagrams and sequence diagrams. |
| interface | A named set of operations that characterize the behavior of an element. |
| interface inheritance | The inheritance of the interface of a more specific element. Does not include inheritance of the implementation. Contrast: <i>implementation inheritance</i> . |
| internal transition | A transition signifying a response to an event without changing the state of an object. |
| layer | The organization of classifiers or packages at the same level of abstraction. A layer represents a horizontal slice through an architecture, whereas a partition represents a vertical slice. Contrast: <i>partition</i> . |
| link | A semantic connection among a tuple of objects. An instance of an association. See: <i>association</i> . |
| link end | An instance of an association end. See: <i>association end</i> . |
| message | A specification of the conveyance of information from one instance to another, with the expectation that activity will ensue. A message may specify the raising of a signal or the call of an operation. |
| metaclass | A class whose instances are classes. Metaclasses are typically used to construct metamodels. |
| meta-metamodel | A model that defines the language for expressing a metamodel. The relationship between a meta-metamodel and a metamodel is analogous to the relationship between a metamodel and a model. |
| metamodel | A model that defines the language for expressing a model. |
| metaobject | A generic term for all metaentities in a metamodeling language. For example, metatypes, metaclasses, metaattributes, and metaassociations. |

| | |
|--------------------------------|--|
| method | The implementation of an operation. It specifies the algorithm or procedure associated with an operation. |
| model | An abstraction of a physical system, with a certain purpose..
See: <i>physical system</i> . |
| [MOF] | Usage note: In the context of the MOF specification, which describes a meta-metamodel, for brevity the meta-metamodel is frequently to as simply the model. |
| model aspect | A dimension of modeling that emphasizes particular qualities of the metamodel. For example, the structural model aspect emphasizes the structural qualities of the metamodel. |
| model elaboration | The process of generating a repository type from a published model. Includes the generation of interfaces and implementations which allows repositories to be instantiated and populated based on, and in compliance with, the model elaborated. |
| model element | An element that is an abstraction drawn from the system being modeled. Contrast: <i>view element</i> . |
| [MOF] | In the MOF specification model elements are considered to be metaobjects. |
| modeling time | Refers to something that occurs during a modeling phase of the software development process. It includes analysis time and design time. Usage note: When discussing object systems, it is often important to distinguish between modeling-time and run-time concerns. See: <i>analysis time</i> , <i>design time</i> . Contrast: <i>run time</i> . |
| module | A software unit of storage and manipulation. Modules include source code modules, binary code modules, and executable code modules. See: <i>component</i> . |
| multiple classification | A semantic variation of generalization in which an object may belong directly to more than one classifier. See: <i>static classification</i> , <i>dynamic classification</i> . |
| multiple inheritance | A semantic variation of generalization in which a type may have more than one supertype. Contrast: <i>single inheritance</i> . |

| | |
|---------------------------|--|
| multiplicity | A specification of the range of allowable cardinalities that a set may assume. Multiplicity specifications may be given for roles within associations, parts within composites, repetitions, and other purposes. Essentially a multiplicity is a (possibly infinite) subset of the non-negative integers. Contrast: <i>cardinality</i> . |
| multi-valued [MOF] | A model element with multiplicity defined whose Multiplicity Type:: upper attribute is set to a number greater than one. The term multi-valued does not pertain to the number of values held by an attribute, parameter, etc. at any point in time. Contrast: <i>single-valued</i> . |
| n-ary association | An association among three or more classes. Each instance of the association is an n-tuple of values from the respective classes. Contrast: <i>binary association</i> . |
| name | A string used to identify a model element. |
| namespace | A part of the model in which the names may be defined and used. Within a namespace, each name has a unique meaning. See: <i>name</i> . |
| node | A node is classifier that represents a run-time computational resource, which generally has at least a memory and often processing capability. Run-time objects and components may reside on nodes. |
| object | An entity with a well-defined boundary and identity that encapsulates state and behavior. State is represented by attributes and relationships, behavior is represented by operations, methods, and state machines. An object is an instance of a class. See: <i>class</i> , <i>instance</i> . |
| object diagram | A diagram that encompasses objects and their relationships at a point in time. An object diagram may be considered a special case of a class diagram or a collaboration diagram. See: <i>class diagram</i> , <i>collaboration diagram</i> . |
| object flow state | A state in an activity graph that represents the passing of an object from the output of actions in one state to the input of actions in another state. |
| object lifeline | A line in a sequence diagram that represents the existence of an object over a period of time. See: <i>sequence diagram</i> . |

| | |
|------------------------------|---|
| operation | A service that can be requested from an object to effect behavior. An operation has a signature, which may restrict the actual parameters that are possible. |
| package | A general purpose mechanism for organizing elements into groups. Packages may be nested within other packages. |
| parameter | The specification of a variable that can be changed, passed, or returned. A parameter may include a name, type, and direction. Parameters are used for operations, messages, and events. Synonyms: <i>formal parameter</i> . Contrast: <i>argument</i> . |
| parameterized element | The descriptor for a class with one or more unbound parameters. Synonym: <i>template</i> . |
| parent | In a generalization relationship, the generalization of another element, the child. See: <i>subclass</i> , <i>subtype</i> . Contrast: <i>child</i> . |
| participate | The connection of a model element to a relationship or to a reified relationship. For example, a class participates in an association, an actor participates in a use case. |
| partition | <ol style="list-style-type: none">1. activity graphs: A portion of an activity graphs that organizes the responsibilities for actions. See: <i>swimlane</i>.2. architecture: A set of related classifiers or packages at the same level of abstraction or across layers in a layered architecture. A partition represents a vertical slice through an architecture, whereas a layer represents a horizontal slice. Contrast: <i>layer</i>. |
| pattern | A template collaboration. |
| persistent object | An object that exists after the process or thread that created it has ceased to exist. |
| postcondition | A constraint that must be true at the completion of an operation. |
| precondition | A constraint that must be true when an operation is invoked. |
| primitive type | A pre-defined basic datatype without any substructure, such as an integer or a string. |

| | |
|------------------------------|---|
| process | <ol style="list-style-type: none">1. A heavyweight unit of concurrency and execution in an operating system. Contrast: <i>thread</i>, which includes heavyweight and lightweight processes. If necessary, an implementation distinction can be made using stereotypes.2. A software development process—the steps and guidelines by which to develop a system.3. To execute an algorithm or otherwise handle something dynamically. |
| projection | A mapping from a set to a subset of it. |
| property | A named value denoting a characteristic of an element. A property has semantic impact. Certain properties are predefined in the UML; others may be user defined. See: tagged value. |
| pseudo-state | A vertex in a state machine that has the form of a state, but doesn't behave as a state. Pseudo-states include initial and history vertices. |
| physical system | <ol style="list-style-type: none">1. The subject of a model.2. A collection of connected physical units, which can include software, hardware and people, that are organized to accomplish a specific purpose. A physical system can be described by one or more models, possibly from different viewpoints. Contrast: system. |
| published model [MOF] | A model which has been frozen, and becomes available for instantiating repositories and for the support in defining other models. A frozen model's model elements cannot be changed. |
| qualifier | An association attribute or tuple of attributes whose values partition the set of objects related to an object across an association. |
| receive [a message] | The handling of a stimulus passed from a sender instance. See: <i>sender</i> , <i>receiver</i> . |
| receiver [object] | The object handling a stimulus passed from a sender object. Contrast: <i>sender</i> . |
| reception | A declaration that a classifier is prepared to react to the receipt of a signal. |
| reference | <ol style="list-style-type: none">1. A denotation of a model element.2. A named slot within a classifier that facilitates navigation to other classifiers. Synonym: <i>pointer</i>. |

| | |
|---------------------------------|--|
| refinement | A relationship that represents a fuller specification of something that has already been specified at a certain level of detail. For example, a design class is a refinement of an analysis class. |
| relationship | A semantic connection among model elements. Examples of relationships include associations and generalizations. |
| repository | A facility for storing object models, interfaces, and implementations. |
| requirement | A desired feature, property, or behavior of a system. |
| responsibility | A contract or obligation of a classifier. |
| reuse | The use of a pre-existing artifact. |
| role | The named specific behavior of an entity participating in a particular context. A role may be static (e.g., an association end) or dynamic (e.g., a collaboration role). |
| run time | The period of time during which a computer program executes. Contrast: <i>modeling time</i> . |
| scenario | A specific sequence of actions that illustrates behaviors. A scenario may be used to illustrate an interaction or the execution of a use case instance. See: <i>interaction</i> . |
| schema [MOF] | In the context of the MOF, a schema is analogous to a package which is a container of model elements. Schema corresponds to an MOF package. Contrast: <i>metamodel</i> , <i>package</i> . |
| semantic variation point | A point of variation in the semantics of a metamodel. It provides an intentional degree of freedom for the interpretation of the metamodel semantics. |
| send [a message] | The passing of a stimulus from a sender instance to a receiver instance. See: <i>sender</i> , <i>receiver</i> . |
| sender [object] | The object passing a stimulus to a receiver object. Contrast: <i>receiver</i> . |

| | |
|------------------------------|--|
| sequence diagram | A diagram that shows object interactions arranged in time sequence. In particular, it shows the objects participating in the interaction and the sequence of messages exchanged. Unlike a collaboration diagram, a sequence diagram includes time sequences but does not include object relationships. A sequence diagram can exist in a generic form (describes all possible scenarios) and in an instance form (describes one actual scenario). Sequence diagrams and collaboration diagrams express similar information, but show it in different ways. See: <i>collaboration diagram</i> . |
| signal | The specification of an asynchronous stimulus communicated between instances. Signals may have parameters. |
| signature | The name and parameters of a behavioral feature. A signature may include an optional returned parameter. |
| single inheritance | A semantic variation of generalization in which a type may have only one supertype. Synonym: <i>multiple inheritance</i> [OMA]. Contrast: <i>multiple inheritance</i> . |
| single valued [MOF] | A model element with multiplicity defined is single valued when its Multiplicity Type:: upper attribute is set to one. The term single-valued does not pertain to the number of values held by an attribute, parameter, etc., at any point in time, since a single-valued attribute (for instance, with a multiplicity lower bound of zero) may have no value. Contrast: <i>multi-valued</i> . |
| specification | A declarative description of what something is or does. Contrast: <i>implementation</i> . |
| state | A condition or situation during the life of an object during which it satisfies some condition, performs some activity, or waits for some event. Contrast: <i>state</i> [OMA]. |
| statechart diagram | A diagram that shows a state machine. See: <i>state machine</i> . |
| state machine | A behavior that specifies the sequences of states that an object or an interaction goes through during its life in response to events, together with its responses and actions. |
| static classification | A semantic variation of generalization in which an object may not change classifier. Contrast: <i>dynamic classification</i> . |

| | |
|--------------------------------|---|
| stereotype | A new type of modeling element that extends the semantics of the metamodel. Stereotypes must be based on certain existing types or classes in the metamodel. Stereotypes may extend the semantics, but not the structure of pre-existing types and classes. Certain stereotypes are predefined in the UML, others may be user defined. Stereotypes are one of three extensibility mechanisms in UML. See: <i>constraint</i> , <i>tagged value</i> . |
| stimulus | The passing of information from one instance to another, such as raising a signal or invoking an operation. The receipt of a signal is normally considered an event. See: <i>message</i> . |
| string | A sequence of text characters. The details of string representation depend on implementation, and may include character sets that support international characters and graphics. |
| structural feature | A static feature of a model element, such as an attribute. |
| structural model aspect | A model aspect that emphasizes the structure of the objects in a system, including their types, classes, relationships, attributes, and operations. |
| subactivity state | A state in an activity graph that represents the execution of a non-atomic sequence of steps that has some duration. |
| subclass | In a generalization relationship, the specialization of another class; the superclass. See: <i>generalization</i> . Contrast: <i>superclass</i> . |
| submachine state | A state in a state machine which is equivalent to a composite state but its contents is described by another state machine. |
| substate | A state that is part of a composite state. See: <i>concurrent state</i> , <i>disjoint state</i> . |
| subpackage | A package that is contained in another package. |
| subsystem | A grouping of model elements that represents a behavioral unit in a physical system. A subsystem offers interfaces and has operations. In addition, the model elements of a subsystem can be partitioned into specification and realization elements. See <i>package</i> . See: <i>physical system</i> . |
| subtype | In a generalization relationship, the specialization of another type; the supertype. See: <i>generalization</i> . Contrast: <i>supertype</i> . |

B OMG Modeling Glossary

| | |
|----------------------------|--|
| superclass | In a generalization relationship, the generalization of another class; the subclass. See: <i>generalization</i> . Contrast: <i>subclass</i> . |
| supertype | In a generalization relationship, the generalization of another type; the subtype. See: <i>generalization</i> . Contrast: <i>subtype</i> . |
| supplier | A classifier that provides services that can be invoked by others. Contrast: <i>client</i> . |
| swimlane | A partition on a activity diagram for organizing the responsibilities for actions. Swimlanes typically correspond to organizational units in a business model. See: <i>partition</i> . |
| synch state | A vertex in a state machine used for synchronizing the concurrent regions of a state machine. |
| system | A top-level subsystem in a model. Contrast: physical system. |
| tagged value | The explicit definition of a property as a name-value pair. In a tagged value, the name is referred as the tag. Certain tags are predefined in the UML; others may be user defined. Tagged values are one of three extensibility mechanisms in UML. See: <i>constraint</i> , <i>stereotype</i> . |
| template | Synonym: <i>parameterized element</i> . |
| thread [of control] | A single path of execution through a program, a dynamic model, or some other representation of control flow. Also, a stereotype for the implementation of an active object as lightweight process. See <i>process</i> . |
| time event | An event that denotes the time elapsed since the current state was entered. See: <i>event</i> . |
| time expression | An expression that resolves to an absolute or relative value of time. |
| timing mark | A denotation for the time at which an event or message occurs. Timing marks may be used in constraints. |
| top level | A stereotype of package denoting the top-most package in a containment hierarchy. The <i>topLevel</i> stereotype defines the outer limit for looking up names, as namespaces “see” outwards. For example, <i>opLevel</i> subsystem represents the top of the subsystem containment hierarchy. |

| | |
|--------------------------|---|
| trace | A dependency that indicates a historical or process relationship between two elements that represent the same concept without specific rules for deriving one from the other. |
| transient object | An object that exists only during the execution of the process or thread that created it. |
| transition | A relationship between two states indicating that an object in the first state will perform certain specified actions and enter the second state when a specified event occurs and specified conditions are satisfied. On such a change of state, the transition is said to fire. |
| type | A stereotype of class that is used to specify a domain of instances (objects) together with the operations applicable to the objects. A type may not contain any methods. See: <i>class</i> , <i>instance</i> . Contrast: <i>interface</i> . |
| type expression | An expression that evaluates to a reference to one or more types. |
| uninterpreted | A placeholder for a type or types whose implementation is not specified by the UML. Every uninterpreted value has a corresponding string representation. See: <i>any</i> [CORBA]. |
| usage | A dependency in which one element (the client) requires the presence of another element (the supplier) for its correct functioning or implementation. |
| use case [class] | The specification of a sequence of actions, including variants, that a system (or other entity) can perform, interacting with actors of the system. See: <i>use case instances</i> . |
| use case diagram | A diagram that shows the relationships among actors and use cases within a system. |
| use case instance | The performance of a sequence of actions being specified in a use case. An instance of a use case. See: <i>use case class</i> . |
| use case model | A model that describes a system's functional requirements in terms of use cases. |

B OMG Modeling Glossary

| | |
|------------------------|---|
| utility | A stereotype that groups global variables and procedures in the form of a class declaration. The utility attributes and operations become global variables and global procedures, respectively. A utility is not a fundamental modeling construct, but a programming convenience. |
| value | An element of a type domain. |
| vertex | A source or a target for a transition in a state machine. A vertex can be either a state or a pseudo-state. See: <i>state</i> , <i>pseudo-state</i> . |
| view | A projection of a model, which is seen from a given perspective or vantage point and omits entities that are not relevant to this perspective. |
| view element | A view element is a textual and/or graphical projection of a collection of model elements. |
| view projection | A projection of model elements onto view elements. A view projection provides a location and a style for each view element. |
| visibility | An enumeration whose value (public, protected, or private) denotes how the model element to which it refers may be seen outside its enclosing namespace. |